

Command Line Tools User Guide

(Formerly the Development System Reference Guide)

UG628 (v 13.4) January 18, 2012



Xilinx is disclosing this user guide, manual, release note, and/or specification (the “Documentation”) to you solely for use in the development of designs to operate with Xilinx hardware devices. You may not reproduce, distribute, republish, download, display, post, or transmit the Documentation in any form or by any means including, but not limited to, electronic, mechanical, photocopying, recording, or otherwise, without the prior written consent of Xilinx. Xilinx expressly disclaims any liability arising out of your use of the Documentation. Xilinx reserves the right, at its sole discretion, to change the Documentation without notice at any time. Xilinx assumes no obligation to correct any errors contained in the Documentation, or to advise you of any corrections or updates. Xilinx expressly disclaims any liability in connection with technical support or assistance that may be provided to you in connection with the Information.

THE DOCUMENTATION IS DISCLOSED TO YOU “AS-IS” WITH NO WARRANTY OF ANY KIND. XILINX MAKES NO OTHER WARRANTIES, WHETHER EXPRESS, IMPLIED, OR STATUTORY, REGARDING THE DOCUMENTATION, INCLUDING ANY WARRANTIES OF MERCHANTABILITY, FITNESS FOR A PARTICULAR PURPOSE, OR NONINFRINGEMENT OF THIRD-PARTY RIGHTS. IN NO EVENT WILL XILINX BE LIABLE FOR ANY CONSEQUENTIAL, INDIRECT, EXEMPLARY, SPECIAL, OR INCIDENTAL DAMAGES, INCLUDING ANY LOSS OF DATA OR LOST PROFITS, ARISING FROM YOUR USE OF THE DOCUMENTATION.

© Copyright 2002-2012 Xilinx Inc. All Rights Reserved. XILINX, the Xilinx logo, the Brand Window and other designated brands included herein are trademarks of Xilinx, Inc. All other trademarks are the property of their respective owners. The PowerPC name and logo are registered trademarks of IBM Corp., and used under license. All other trademarks are the property of their respective owners.

Revision History

The following table shows the revision history for this document.

Date	Version	
03/01/2011	13.1 download	Adding information for Xilinx® 7 series FPGA devices.
03/02/2011	13.1 Web release	Additional updates for Xilinx 7 series FPGA devices.
07/06/2011	13.2 download	Updated information on Xilinx 7 series FPGA supported devices (CR #610690 and edit requests) Updated all Processes and Properties tables to match the GUI. Added Static Timing Process Properties table based on GUI Additional detail to Tclk set_family option (CR #604108) Added USR_ACCESS option to BitGen chapter (edit request) Removed CLT documentation options that are obsoleted by change to map -global_opt flow (CR #604740) Misc. other corrections to match document with how the software works (CR #590750, #593738, #594127, #595446, #596310, #596916, #604740, #609259)
10/19/2011	13.3 download	Documented bitgen options EssentialBits, RevisionSelect, and RevisionSelect_tristate Added Tcl command information for EssentialBits, RevisionSelect, and RevisionSelect_tristate Updated BitGen output file table to add EssentialBits files Updated BitGen flow diagram to include all current input and output files Final characterization for bitgen -g ConfigRate for 7 series devices Added links from Bitgen options table to options

Date	Version	
1/18/2012	13.4 download	Reorganized SmartXplorer chapter to better expose how to run strategies in parallel Addr bitgen -g next_config_reboot option par -activityfile switch is not supported in newer architectures

Table of Contents

Revision History	2
Chapter 1 Introduction	9
Command Line Program Overview	9
Command Line Syntax.....	10
Command Line Options	10
Invoking Command Line Programs.....	14
Chapter 2 Design Flow.....	15
Design Flow Overview	15
Design Entry and Synthesis	18
Design Implementation.....	22
Design Verification.....	25
FPGA Design Tips	31
Chapter 3 PARTGen	33
PARTGen Overview.....	33
PARTGen Syntax.....	39
PARTGen Command Line Options.....	39
Chapter 4 NetGen	43
NetGen Overview	43
NetGen Simulation Flow.....	45
NetGen Equivalence Checking Flow.....	55
NetGen Static Timing Analysis Flow	59
Preserving and Writing Hierarchy Files	63
Dedicated Global Signals in Back-Annotation Simulation	65
Chapter 5 Logical Design Rule Check (DRC).....	67
Logical DRC Overview	67
Logical DRC Checks	67
Chapter 6 NGDBuild.....	71
NGDBuild Overview	71
NGDBuild Syntax.....	74
NGDBuild Options.....	74
Chapter 7 MAP.....	81
MAP Overview.....	81

MAP Process.....	83
MAP Syntax.....	84
MAP Options.....	86
Resynthesis and Physical Synthesis Optimizations	97
Guided Mapping.....	97
Simulating Map Results	98
MAP Report (MRP) File.....	99
Physical Synthesis Report (PSR) File.....	105
Halting MAP	107
Chapter 8 Physical Design Rule Check.....	109
DRC Overview	109
DRC Syntax	109
DRC Options	110
DRC Checks	111
DRC Errors and Warnings	111
Chapter 9 Place and Route (PAR)	113
PAR Overview	113
PAR Process	115
PAR Syntax	116
Detailed Listing of Options.....	117
PAR Reports	123
ReportGen	131
Halting PAR.....	133
Chapter 10 SmartXplorer	135
SmartXplorer Overview.....	135
Using SmartXplorer Strategies.....	135
Running SmartXplorer Strategies in Parallel.....	142
Using Synthesis with SmartXplorer	146
SmartXplorer Reports	148
Setting Up SmartXplorer to Run on SSH	151
SmartXplorer Command Line Reference.....	151
Chapter 11 XPWR	163
XPWR Overview	163
XPWR Syntax.....	164
XPWR Command Line Options	165
XPWR Command Line Examples	167

Using XPWR.....	167
Power Reports	169
Chapter 12 PIN2UCF	171
PIN2UCF Overview	171
PIN2UCF Syntax	174
PIN2UCF Command Line Options	175
Chapter 13 TRACE.....	177
TRACE Overview.....	177
TRACE Syntax.....	178
TRACE Options	179
TRACE Command Line Examples	184
TRACE Reports	184
OFFSET Constraints.....	200
PERIOD Constraints	208
Halting TRACE	212
Chapter 14 Speedprint.....	213
Speedprint Overview.....	213
Speedprint Command Line Syntax.....	217
Speedprint Command Line Options.....	217
Chapter 15 BitGen	219
BitGen Overview	219
BitGen Command Line Syntax.....	222
BitGen Command Line Options	223
Chapter 16 BSDLAnno.....	249
BSDLAnno Overview	249
BSDLAnno Command Line Syntax	250
BSDLAnno Command Line Options	250
BSDLAnno File Composition	251
Boundary Scan Behavior in Xilinx Devices.....	257
Chapter 17 PROMGen	259
PROMGen Overview.....	259
PROMGen Syntax.....	260
PROMGen Options.....	261
Bit Swapping in PROM Files	267
PROMGen Examples	267

Chapter 18	IBISWriter	269
	IBISWriter Overview	269
	IBISWriter Syntax	270
	IBISWriter Options	271
Chapter 19	CPLDFit.....	273
	CPLDFit Overview.....	273
	CPLDFit Syntax.....	274
	CPLDFit Options.....	275
Chapter 20	TSIM	283
	TSIM Overview.....	283
	TSIM Syntax.....	283
Chapter 21	TAEngine	285
	TAEngine Overview.....	285
	TAEngine Syntax.....	286
	TAEngine Options.....	286
Chapter 22	Hprep6	287
	Hprep6 Overview.....	287
	Hprep6 Options.....	288
Chapter 23	XFLOW	291
	XFLOW Overview	291
	XFLOW Syntax	295
	XFLOW Flow Types	296
	Flow Files.....	301
	XFLOW Option Files.....	303
	XFLOW Options.....	305
	Running XFLOW.....	309
Chapter 24	NGCBuild.....	311
	NGCBuild Overview	311
	NGCBuild Syntax	312
	NGCBuild Options	313
Chapter 25	Compplib	319
	Compplib Overview.....	319
	Compplib Syntax.....	320
	Compplib Options.....	321
	Compplib Command Line Examples	326

Specifying Runtime Options.....	327
Sample Configuration File (Windows Version)	330
Chapter 26 XWebTalk	335
WebTalk Overview.....	335
XWebTalk Syntax	336
XWebTalk Options	336
Chapter 27 Tcl Reference	339
Tcl Overview.....	339
Tcl Fundamentals	340
Project and Process Properties.....	342
Xilinx Tcl Commands for General Use	361
Xilinx Tcl Commands for Advanced Scripting.....	378
Example Tcl Scripts	393
Appendix A ISE Design Suite Files.....	399
Appendix B EDIF2NGD and NGDBuild	405
EDIF2NGD Overview.....	405
EDIF2NGD Options.....	407
NGDBuild	409
Appendix C Additional Resources.....	419

Introduction

This chapter describes the command line programs for the ISE® Design Suite. This guide was formerly known as the *Development System Reference Guide*, but has been renamed to *Command Line Tools User Guide*.

Command Line Program Overview

Xilinx® software command line programs allow you to implement and verify your design. The following table lists the programs you can use for each step in the design flow. For detailed information, see the [Design Flow](#) chapter in this guide.

Command Line Programs in the Design Flow

Design Flow Step	Command Line Program
Design Implementation	NGDBuild, MAP, PAR, SmartXplorer, BitGen
Timing-driven Placement and Routing, Re-synthesis, & Physical Synthesis Optimizations	MAP Note MAP uses specified options to enable timing-driven placement and routing (-timing), and re-synthesis and physical synthesis optimizations that can transform a design to meet timing requirements.
Timing Simulation and Back Annotation (Design Verification)	NetGen
Static Timing Analysis (Design Verification)	TRACE

You can run these programs in the standard design flow or use special options to run the programs for design preservation. Each command line program has multiple options, which allow you to control how a program executes. For example, you can set options to change output file names, to set a part number for your design, or to specify files to read in when executing the program. You can also use options to create guide files and run guide mode to maintain the performance of a previously implemented design.

Some of the command line programs described in this guide underlie many of the Xilinx Graphical User Interfaces (GUIs). The GUIs can be used with the command line programs or alone. For information on the GUIs, see the online Help provided with each Xilinx tool.

Command Line Syntax

Command line syntax always begins with the command line program name. The program name is followed by any options and then by file names. Use the following rules when specifying command line options:

- Enter options in any order, preceded them with a dash (minus sign on the keyboard) and separate them with spaces.
- Be consistent with upper case and lower case.
- When an option requires a parameter, separate the parameter from the option by spaces or tabs. For example, the following shows the command line syntax for running PAR with the effort level set to high:
 - Correct: `par -ol high`
 - Incorrect: `par -olhigh`
- When using options that can be specified multiple times, precede each parameter with the option letter. In this example, the -l option shows the list of libraries to search:
 - Correct: `-l xilinxun -l synopsys`
 - Incorrect: `-l xilinxun synopsys`
- Enter parameters that are bound to an option after the option.
 - Correct: `-f command_file`
 - Incorrect: `command_file -f`

Use the following rules when specifying file names:

- Enter file names in the order specified in the chapter that describes the command line program. In this example the correct order is program, input file, output file, and then physical constraints file.
 - Correct: `par input.ncd output.ncd freq.pcf`
 - Incorrect: `par input.ncd freq.pcf output.ncd`
- Use lower case for all file extensions (for example, .ncd).

Command Line Options

The following options are common to many of the command line programs provided with the ISE® Design Suite.

- [-f \(Execute Commands File\)](#)
- [-h \(Help\)](#)
- [-intstyle \(Integration Style\)](#)
- [-p \(Part Number\)](#)

-f (Execute Commands File)

With any Xilinx® command line program for use with FPGA designs, you can store command line program options and file names in a command file. You can then execute the arguments by entering the program name with the `-f` option followed by the name of the command file. This is useful if you frequently execute the same arguments each time you execute a program or if the command line command becomes too long.

Syntax

`-f command_file`

You can use the file in the following ways:

- To supply all of the command options and file names for the program, as in the following example:

```
par -f command_file
```

command_file is the name of the file that contains the command options and file names.

- To insert certain command options and file names within the command line, as in the following example:

```
par -f placeoptions -f routeoptions design_i .ncd design_o .ncd
```

– *placeoptions* is the name of a file containing placement command parameters.

– *routeoptions* is the name of a file containing routing command parameters.

You create the command file in ASCII format. Use the following rules when creating the command file:

- Separate program options and file names with spaces.
- Precede comments with the pound sign (#).
- Put new lines or tabs anywhere white space is allowed on the Linux or DOS command line.
- Put all arguments on the same line, one argument per line, or a combination of these.
- All carriage returns and other non-printable characters are treated as spaces and ignored.
- No line length limitation exists within the file.

Example

Following is an example of a command file:

```
#command line options for par for design mine.ncd
-w
01 5
/home/yourname/designs/xilinx/mine.ncd
#directory for output designs
/home/yourname/designs/xilinx/output.dir
#use timing constraints file
/home/yourname/designs/xilinx/mine.pcf
```

-h (Help)

When you enter the program name followed by this option, you will get a message listing all options for the program and their parameters, as well as the file types used by the program. The message also explains each of the options.

Syntax

-h

-help

Symbol	Description
[]	Encloses items that are optional.
{ }	Encloses items that may be repeated.
<i>italics</i>	Indicates a variable name or number for which you must substitute information.
,	Shows a range for an integer variable.
-	Shows the start of an option name.
:	Binds a variable name to a range.
	Logical OR to show a choice of one out of many items. The OR operator may only separate logical groups or literal keywords.
()	Encloses a logical grouping for a choice between sub-formats.

Example

Following are examples of syntax used for file names:

- *infile*[.ncd] shows that typing the .ncd extension is optional but that the extension must be .ncd.
- *infile.edn* shows that the .edn extension is optional and is appended only if there is no other extension in the file name.

For architecture-specific programs, such as BitGen, you can enter the following to get a verbose help message for the specified architecture:

```
program_name -h architecture_name
```

You can redirect the help message to a file to read later or to print out by entering the following:

```
program_name -h > filename
```

On the Linux command line, enter the following to redirect the help message to a file and return to the command prompt.

```
program_name -h > & filename
```

-intstyle (Integration Style)

This option limits screen output, based on the integration style that you are running, to warning and error messages only.

Syntax

```
-intstyle ise|xflow|silent
```

When using **-intstyle**, one of three modes must be specified:

- **-intstyle ise** indicates the program is being run as part of an integrated design environment.
- **-intstyle xflow** indicates the program is being run as part of an integrated batch flow.
- **-intstyle silent** limits screen output to warning and error messages only.

Note **-intstyle** is automatically invoked when running in an integrated environment such as Project Navigator or XFLOW.

-p (Part Number)

This option specifies the part into which your design is implemented.

Syntax

-p *part_number*

This option can specify an architecture only, a complete part specification (device, package, and speed), or a partial specification (for example, device and package only). The part number or device name must be from a device library you have installed on your system.

A complete Xilinx® part number consists of the following elements:

- Architecture (for example, spartan3e)
- Device (for example, xc3s100e)
- Package (for example, vq100)
- Speed (for example, -4)

Note The Speedprint program lists block delays for device speed grades. The **-s** option lets you specify a speed grade. If you do not specify a speed grade, Speedprint reports the default speed grade for the device you are targeting.

Specifying Part Numbers

You can specify a part number at various points in the design flow, not all of which require the **-p** option.

- In the input netlist (does not require the **-p** option)
- In a Netlist Constraints File (NCF) (does not require the **-p** option)
- With the **-p** option when you run a netlist reader (EDIF2NGD)
- In the User Constraints File (UCF) (does not require the **-p** option)
- With the **-p** option when you run NGDBuild

By the time you run NGDBuild, you must have already specified a device architecture.

- With the **-p** option when you run MAP

When you run MAP you must specify an architecture, device, and package, either on the MAP command line or earlier in the design flow. If you do not specify a speed, MAP selects a default speed. You can only run MAP using a part number from the architecture you specified when you ran NGCBuild.

- With the **-p** option when you run SmartXplorer (FPGA designs only)
- With the **-p** option when you run CPLDFit (CPLD designs only)

Note Part numbers specified in a later step of the design flow override a part number specified in an earlier step. For example, a part specified when you run MAP overrides a part specified in the input netlist.

Examples

The following examples show how to specify parts on the command line.

Specification	Examples
Architecture only	virtex4 virtex5 spartan3 spartan3a xc9500 xpla3 (CoolRunner™ XPLA3 devices)
Device only	xc4vfx12 xc3s100e
DevicePackage	xc4fx12sf363 xc3s100evq100
Device-Package	xc4vfx12-sf363 xc3s100e-vq100
DeviceSpeed-Package	xc4vfx1210-sf363 xc3s100e4-vq100
DevicePackage-Speed	xc4fx12sf363-10 xc3s100evq100-4
Device-Speed-Package	xc4vfx12-10-sf363 xc3s100e-4-vq100
Device-SpeedPackage	xc4vfx12-10sf363 xc3s100e-4vq100

Invoking Command Line Programs

You start Xilinx® command line programs by entering a command at the Linux or DOS command line. See the program-specific chapters in this book for the appropriate syntax

Xilinx also offers the XFLOW program, which lets you automate the running of several programs at one time. See the [XFLOW](#) chapter for more information.

Design Flow

This chapter describes the process for creating, implementing, verifying, and downloading designs for Xilinx® FPGA and CPLD devices. For a complete description of Xilinx FPGA and CPLDs devices, refer to the Xilinx Data Sheets at: <http://www.xilinx.com/support/>

Design Flow Overview

The standard design flow comprises the following steps:

1. **Design Entry and Synthesis** - Create your design using a Xilinx®-supported schematic editor, a Hardware Description Language (HDL) for text-based entry, or both. If you use an HDL for text-based entry, you must synthesize the HDL file into an EDIF file or, if you are using the Xilinx Synthesis Technology (XST) GUI, you must synthesize the HDL file into an NGC file.
2. **Design Implementation** - Convert the logical design file format, such as EDIF, that you created in the design entry and synthesis stage into a physical file format by implementing to a specific Xilinx architecture. The physical information is contained in the Native Circuit Description (NCD) file for FPGAs and the VM6 file for CPLDs. Then create a bitstream file from these files and optionally program a PROM or EPROM for subsequent programming of your Xilinx device.
3. **Design Verification** - Using a gate-level simulator or cable, ensure that your design meets timing requirements and functions properly. See the iMPACT online help for information about Xilinx download cables and demonstration boards.

The full design flow is an iterative process of entering, implementing, and verifying your design until it is correct and complete. The command line tools provided with the ISE® Design Suite allow quick design iterations through the design flow cycle. Xilinx devices permit unlimited reprogramming. You do not need to discard devices when debugging your design in circuit.

Xilinx Design Flow

This figure shows the standard Xilinx design flow.

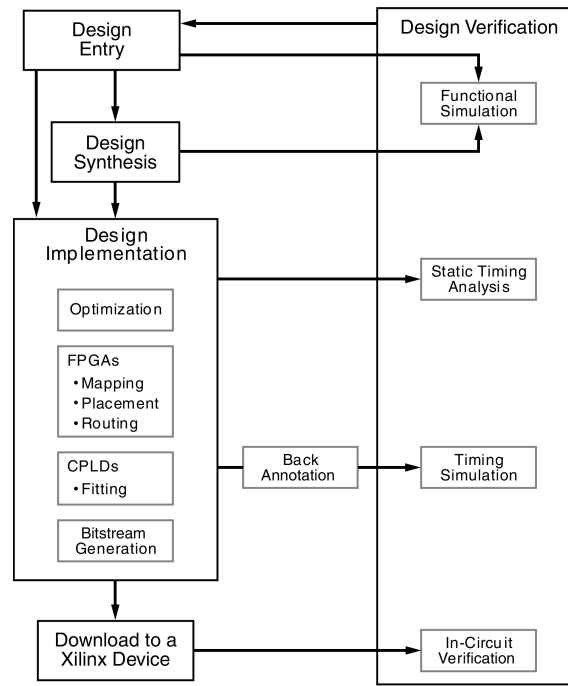

X09537

Xilinx Software Design Flow (FPGAs)

This figure shows the Xilinx software flow chart for FPGA designs.

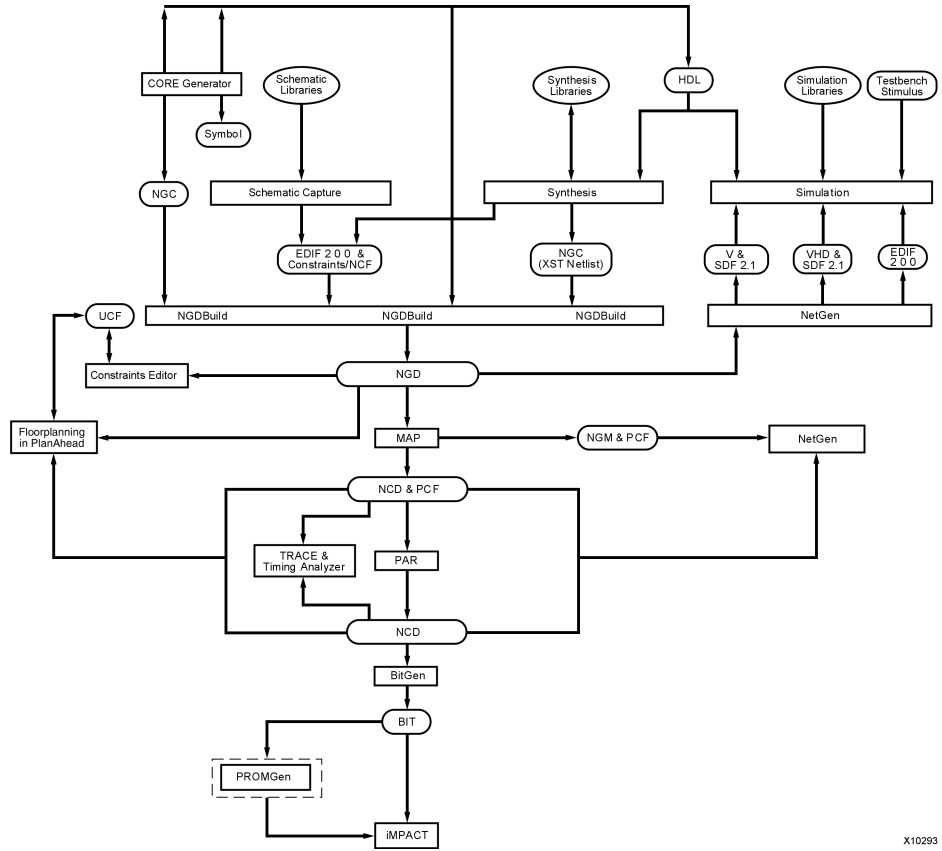

X10293

Xilinx Software Design Flow (CPLDs)

This figure shows the Xilinx software flow chart for CPLD designs.

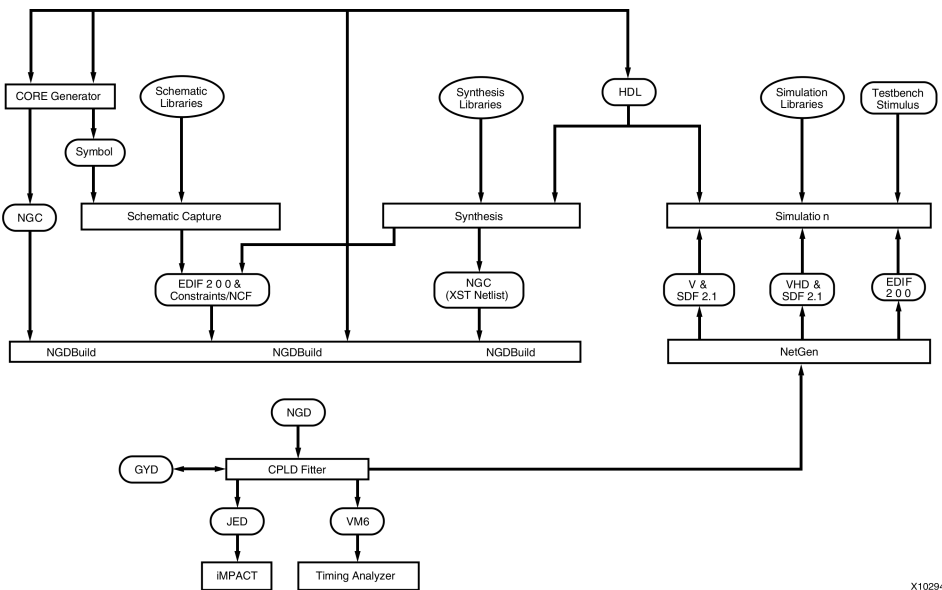

X10294

Design Entry and Synthesis

You can enter a design with a schematic editor or a text-based tool. Design entry begins with a design concept, expressed as a drawing or functional description. From the original design, a netlist is created, then synthesized and translated into a native generic object (NGO) file. This file is fed into the Xilinx® software program called NGDBuild, which produces a logical Native Generic Database (NGD) file.

The following figure shows the design entry and synthesis process.

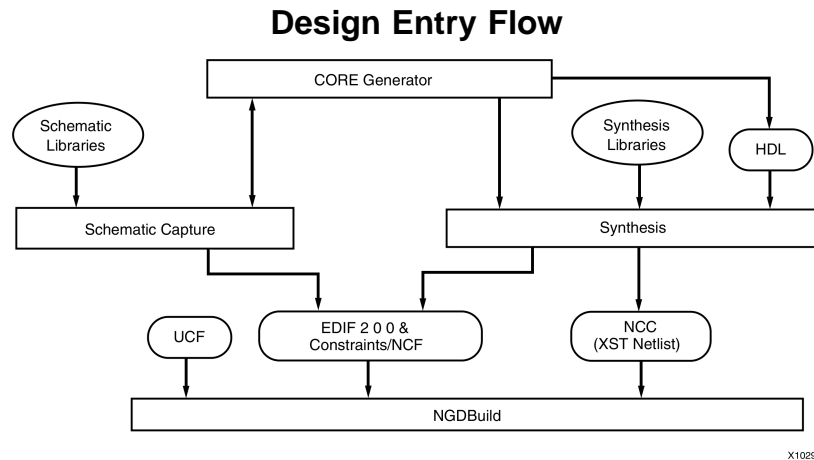

Hierarchical Design

Design hierarchy is important in both schematic and HDL entry for the following reasons:

- Helps you conceptualize your design
- Adds structure to your design
- Promotes easier design debugging
- Makes it easier to combine different design entry methods (schematic, HDL, or state editor) for different parts of your design
- Makes it easier to design incrementally, which consists of designing, implementing, and verifying individual parts of a design in stages
- Reduces optimization time
- Facilitates concurrent design, which is the process of dividing a design among a number of people who develop different parts of the design in parallel.

In hierarchical designing, a specific hierarchical name identifies each library element, unique block, and instance you create. The following example shows a hierarchical name with a 2-input OR gate in the first instance of a multiplexer in a 4-bit counter:

```
/Acc/alu_1/mult_4/8count_3/4bit_0/mux_1/or2
```

Xilinx® strongly recommends that you name the components and nets in your design. These names are preserved and used by FPGA Editor. These names are also used for back-annotation and appear in the debug and analysis tools. If you do not name your components and nets, the Schematic Editor automatically generates the names. For example, if left unnamed, the software might name the previous example, as follows:

```
/$1a123/$1b942/$1c23/$1d235/$1e121/$1g123/$1h57
```

Note It is difficult to analyze circuits with automatically generated names, because the names only have meaning for Xilinx software.

Partitions

In hierarchical design flows, such as Design Preservation and Partial Reconfiguration, partitions are used to define hierarchical boundaries so that a complex design can be broken up into smaller blocks. Partitions create a boundary or insulation around the hierarchical module, which isolates the module from other parts of the design. A partition that has been implemented and exported can be re-inserted into the design using a simple cut-and-paste type function, which preserves the placement and routing results for the isolated module. All of the partition definitions and controls are done in a file called `xpartition.xml`. For more information on using hierarchical design flows and implementing partitions, see the [Hierarchical Design Methodology Guide \(UG748\)](#).

PXML File

Partition definitions are contained in the `xpartition.xml` file. The PXML file name is case-sensitive, and must be named `xpartition.xml`. The top level module of the design must be defined as a partition in addition to any optional lower level partitions. The PXML file can be created by hand, from scripts, or from a tool such as the PlanAhead™ software. The PXML will be picked up automatically by the ISE® Design Suite implementation tools when located in the current working directory. For more information about using the `xpartition.xml` file, see the [Hierarchical Design Methodology Guide \(UG748\)](#). An example `xpartition.xml` file is available at `%XILINX%/PlanAhead/testcases/templates` (where `%XILINX%` is your installation directory) if you wish to create a PXML file by hand.

Note All paths in the PXML file must be absolute paths.

```
<?xml version="1.0" encoding="UTF-8" ?>

<Project FileVersion="1.2" Name="Example" ProjectVersion="2.0">
  <Partition Name="/top" State="implement" ImportLocation="NONE">
    <Partition Name="/top/module_A" State="import" ImportLocation="/home/user/Example/import" Preserve="routing">
    </Partition>
    <Partition Name="/top/module_B" State="import" ImportLocation="/home/user/Example/import" Preserve="routing">
    </Partition>
    <Partition Name="/top/module_C" State="implement" ImportLocation="/home/user/Example/import" Preserve="placement">
    </Partition>
  </Partition>
</Project>
```

PXML attributes for Project definition

Attribute name	Value	Description
FileVersion	1.2	Used for internal purposes. Do <i>not</i> change this value.
Name	<i>Project_Name</i>	<i>Project_Name</i> is user defined.
ProjectVersion	2.0	Used for internal purposes. Do <i>not</i> change this value.

PXML attributes for Partition definition

Attribute name	Value	Description
Name	<i>Partition_Name</i>	Hierarchical instance name of module in which the partition should be applied.
State	"implement"	Partition is implemented from scratch.
	"import"	Partition is imported and preserved according to the level set by Preserve .
ImportLocation	<i>path</i>	Ignored if State does not equal "import." The path can be relative or absolute, but the location specified must contain a valid "export" directory when State=import . "NONE" is a predefined keyword for no import directory.
ImportTag	<i>Partition_Name</i>	Allows a partition to be imported into a different level of hierarchy than it was initially implemented in. Set the value to the hierarchical instance name of the partition where it was implemented.
Preserve	"routing"	100% placement and routing is preserved. This is the default for the top level Partition.
	"placement"	Placement is preserved but routing can be modified.
	"synthesis"	Placement and routing can be modified.
	"inherit"	Inherit value from the parent partition. This is the default for all partitions except the top level partition.
BoundaryOpt	"all"	Enables the implementation tools to do optimization on partition ports connected to constraints as well as unused partition ports.
	"none"	Normal partition optimization rules apply. Optimization is allowed only within partition boundaries. This is the default value.

Schematic Entry Overview

Schematic tools provide a graphic interface for design entry. You can use these tools to connect symbols representing the logic components in your design. You can build your design with individual gates, or you can combine gates to create functional blocks. This section focuses on ways to enter functional blocks using library elements and the CORE Generator™ tool.

Library Elements

Primitives and macros are the "building blocks" of component libraries. Xilinx® libraries provide primitives, as well as common high-level macro functions. Primitives are basic circuit elements, such as AND and OR gates. Each primitive has a unique library name, symbol, and description. Macros contain multiple library elements, which can include primitives and other macros.

You can use the following types of macros with Xilinx FPGAs:

- Soft macros have pre-defined functionality but have flexible mapping, placement, and routing. Soft macros are available for all FPGAs.
- Relationally placed macros (RPMs) have fixed mapping and relative placement. RPMs are available for all device families, except the XC9500 family.

Macros are not available for synthesis because synthesis tools have their own module generators and do not require RPMs. If you wish to override the module generation, you can instantiate modules created using CORE Generator. For most leading-edge synthesis tools, this does not offer an advantage unless it is for a module that cannot be inferred.

CORE Generator Tool (FPGAs Only)

The Xilinx CORE Generator tool delivers parameterizable cores that are optimized for Xilinx FPGAs. The library includes cores ranging from simple delay elements to complex DSP (Digital Signal Processing) filters and multiplexers. For details, refer to the CORE Generator Help (part of ISE Help). You can also refer to the Xilinx IP (Intellectual Property) Center Web site at <http://www.xilinx.com/ipcenter>, which offers the latest IP solutions. These solutions include design reuse tools, free reference designs, Digital Signal Processing (DSP), PCI™ solutions, IP implementation tools, cores, specialized system level services, and vertical application IP solutions.

HDL Entry and Synthesis

A typical Hardware Description Language (HDL) supports a mixed-level description in which gate and netlist constructs are used with functional descriptions. This mixed-level capability lets you describe system architectures at a high level of abstraction and then incrementally refine the detailed gate-level implementation of a design.

HDL descriptions offer the following advantages:

- You can verify design functionality early in the design process. A design written as an HDL description can be simulated immediately. Design simulation at this high level, at the gate-level before implementation, allows you to evaluate architectural and design decisions.
- An HDL description is more easily read and understood than a netlist or schematic description. HDL descriptions provide technology-independent documentation of a design and its functionality. Because the initial HDL design description is technology independent, you can use it again to generate the design in a different technology, without having to translate it from the original technology.
- Large designs are easier to handle with HDL tools than schematic tools.

After you create your HDL design, you must synthesize it. During synthesis, behavioral information in the HDL file is translated into a structural netlist, and the design is optimized for a Xilinx® device. Xilinx supports HDL synthesis tools for several third-party synthesis vendors. In addition, Xilinx offers its own synthesis tool, Xilinx Synthesis Technology (XST). For more information, see the *XST User Guide for Virtex-4, Virtex-5, Spartan-3, and Newer CPLD Devices (UG627)* or the *XST User Guide for Virtex-6, Spartan-6, and 7 Series Devices (UG687)*. For detailed information on synthesis, see the *Synthesis and Simulation Design Guide (UG626)*.

Functional Simulation

After you create your design, you can simulate it. Functional simulation tests the logic in your design to determine if it works properly. You can save time during subsequent design steps if you perform functional simulation early in the design flow. See [Simulation](#) for more information.

Constraints

You may want to constrain your design within certain timing or placement parameters. You can specify mapping, block placement, and timing specifications.

You can enter constraints manually or use the Constraints Editor or FPGA Editor, which are graphical user interface (GUI) tools provided by Xilinx®. You can use the Timing Analyzer GUI or TRACE command line program to evaluate the circuit against these constraints by generating a static timing analysis of your design. See [the TRACE chapter](#) and the online Help provided with the ISE® Design Suite for more information. For more information on constraints, see the [Constraints Guide \(UG625\)](#).

Mapping Constraints (FPGAs Only)

You can specify how a block of logic is mapped into CLBs using an FMAP for all Spartan® and Virtex® FPGA architectures. These mapping symbols can be used in your schematic. However, if you overuse these specifications, it may be difficult to route your design.

Block Placement

Block placement can be constrained to a specific location, to one of multiple locations, or to a location range. Locations can be specified in the schematic, with synthesis tools, or in the User Constraints File (UCF). Poor block placement can adversely affect both the placement and the routing of a design. Only I/O blocks require placement to meet external pin requirements.

Timing Specifications

You can specify timing requirements for paths in your design. PAR uses these timing specifications to achieve optimum performance when placing and routing your design.

Netlist Translation Programs

Netlist translation programs let you read netlists into the Xilinx® software tools. EDIF2NGD lets you read an Electronic Data Interchange Format (EDIF) 2.0.0 file. The NGDBuild program automatically invokes these programs as needed to convert your EDIF file to an NGD file, the required format for the Xilinx software tools. NGC files output from the Xilinx XST synthesis tool are read in by NGDBuild directly.

You can find detailed descriptions of the EDIF2NGD, and NGDBuild programs in [the NGDBuild chapter](#) and [the EDIF2NGD and NGDBuild Appendix](#).

Design Implementation

Design Implementation begins with the mapping or fitting of a logical design file to a specific device and is complete when the physical design is successfully routed and a bitstream is generated. You can alter constraints during implementation just as you did during the Design Entry step. See [Constraints](#) for information.

The following figure shows the design implementation process for FPGA designs:

Design Implementation Flow (FPGAs)

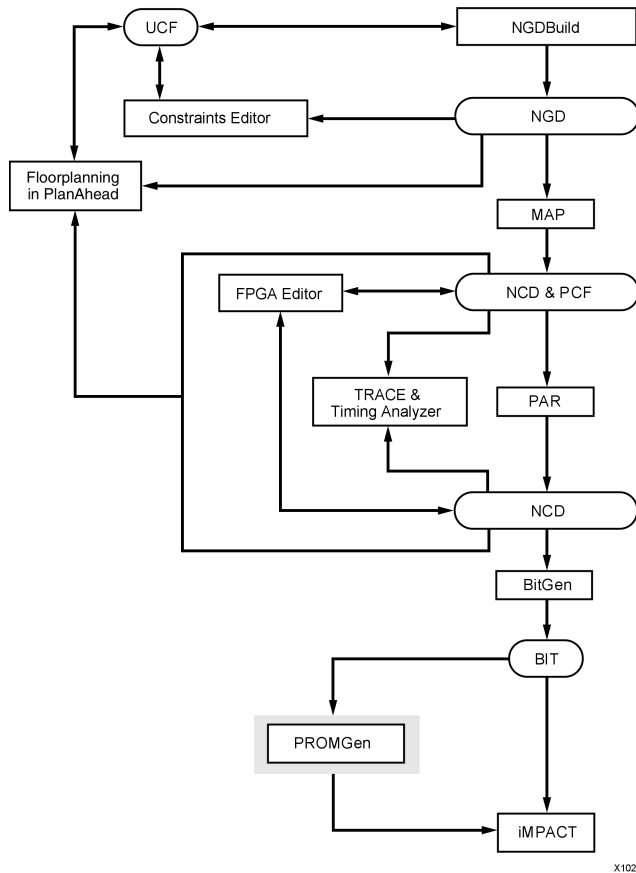

X10296

The following figure shows the design implementation process for CPLD designs:

Design Implementation Flow (CPLDs)

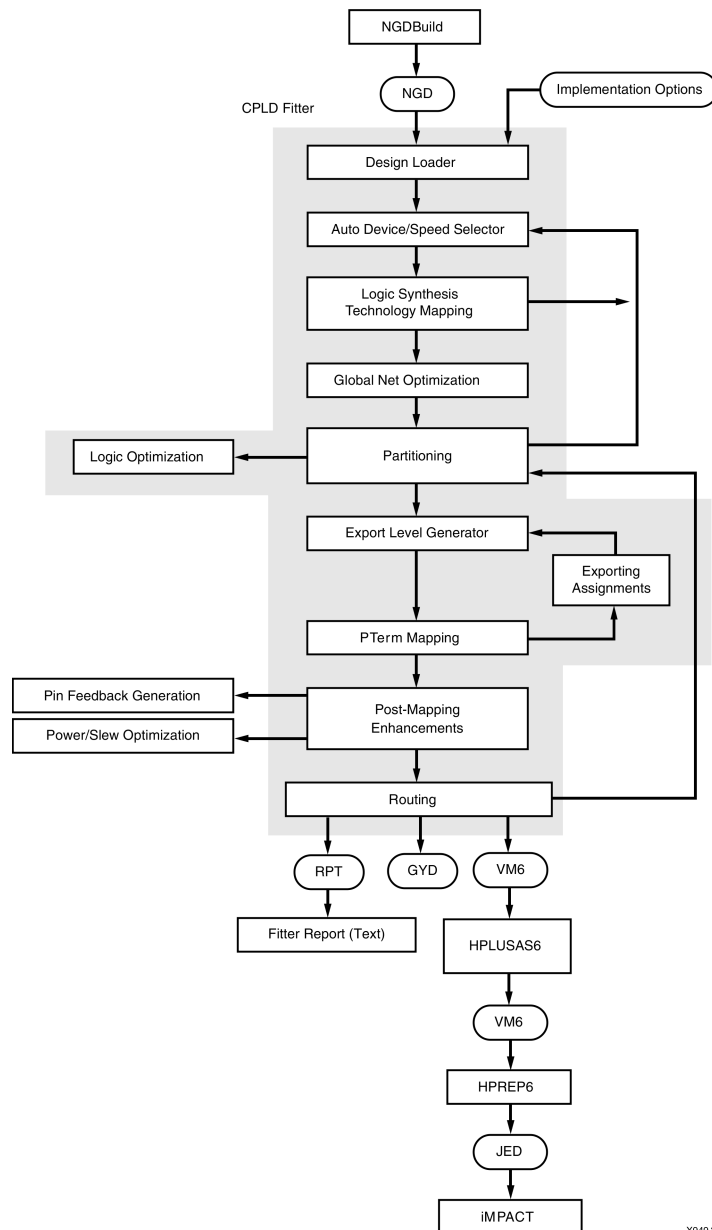

X049 3

Mapping (FPGAs Only)

For FPGAs, the MAP command line program maps a logical design to a Xilinx® FPGA. The input to MAP is an NGD file, which contains a logical description of the design in terms of both the hierarchical components used to develop the design and the lower-level Xilinx primitives, and any number of NMC (hard placed-and-routed macro) files, each of which contains the definition of a physical macro. MAP then maps the logic to the components (logic cells, I/O cells, and other components) in the target Xilinx FPGA.

The output design from MAP is an NCD file, which is a physical representation of the design mapped to the components in the Xilinx FPGA. The NCD file can then be placed and routed, using the PAR command line program. See [the MAP chapter](#) for detailed information.

Note MAP provides options that enable advanced optimizations that are capable of improving timing results beyond standard implementations. These advanced optimizations can transform a design prior to or after placement. Optimizations can be applied at two different stages in the Xilinx design flow. The first stage happens right after the initial mapping of the logic to the architecture slices; the second stage is after placement. See [Re-Synthesis and Physical Synthesis Optimizations](#) in the MAP chapter for more information.

Placing and Routing (FPGAs Only)

For FPGAs, the PAR command line program takes a mapped NCD file as input, places and routes the design, and outputs a placed and routed Native Circuit Description (NCD) file, which is used by the bitstream generator, BitGen. The output NCD file can also act as a guide file when you reiterate placement and routing for a design to which minor changes have been made after the previous iteration. See [the PAR chapter](#) for detailed information.

You can also use FPGA Editor to do the following:

- Place and route critical components before running automatic place and route tools on an entire design.
- Modify placement and routing manually. The editor allows both automatic and manual component placement and routing.

Note For more information, see the online Help provided with FPGA Editor.

Bitstream Generation (FPGAs Only)

For FPGAs, the BitGen command line program produces a bitstream for Xilinx® device configuration. BitGen takes a fully routed NCD file as its input and produces a configuration bitstream, which is a binary file with a `.bit` extension. The BIT file contains all of the configuration information from the NCD file defining the internal logic and interconnections of the FPGA, plus device-specific information from other files associated with the target device. See [the BitGen chapter](#) for detailed information.

After you generate your BIT file, you can download it to a device using the iMPACT GUI. You can also format the BIT file into a PROM file using the PROMGen command line program and then download it to a device using the iMPACT GUI. See [the PROMGen chapter](#) of this guide or the iMPACT online help for more information.

Design Verification

Design verification is testing the functionality and performance of your design. You can verify Xilinx® designs in the following ways:

- Simulation (functional and timing)
- Static timing analysis
- In-circuit verification

The following table lists the different design tools used for each verification type.

Verification Tools

Verification Type	Tools
Simulation	Third-party simulators (integrated and non-integrated)
Static Timing Analysis	TRACE (command line program) Timing Analyzer (GUI) Mentor Graphics TAU and Innoveda BLAST software for use with the STAMP file format (for I/O timing verification only)
In-Circuit Verification	Design Rule Checker (command line program) Download cable

Design verification procedures should occur throughout your design process, as shown in the following figures.

Three Verification Methods of the Design Flow (FPGAs)

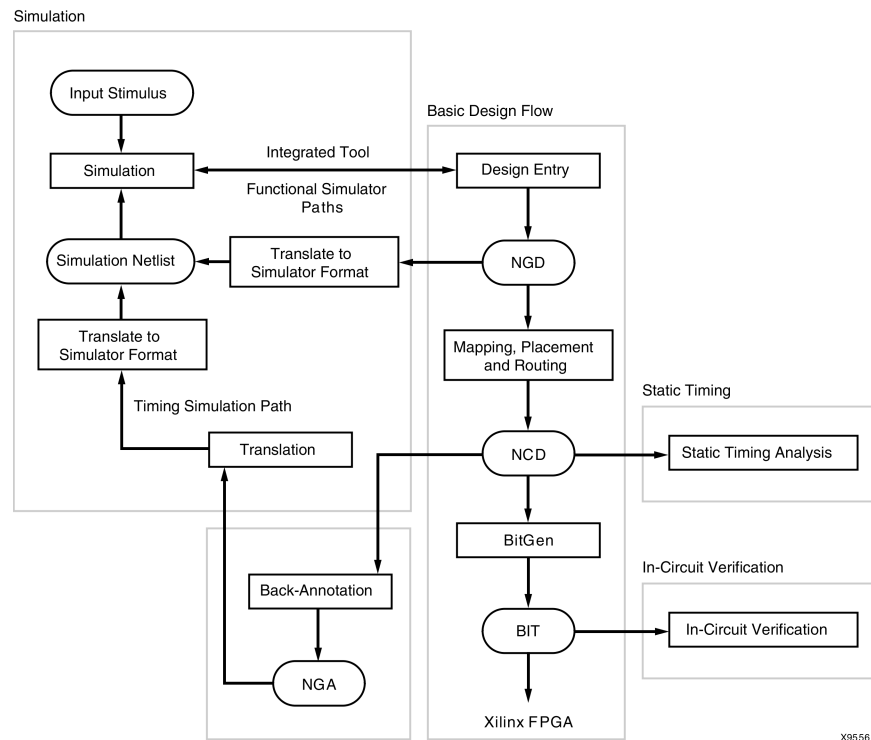

The following figure shows the verification methods of the design flow for CPLDs.

Three Verification Methods of the Design Flow (CPLDs)

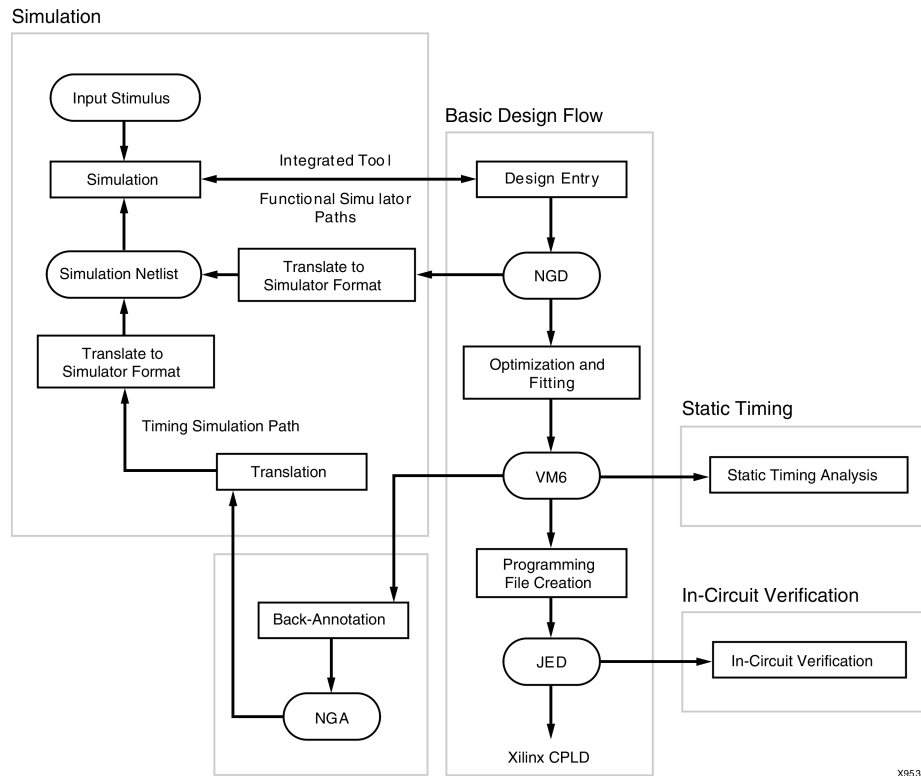

Simulation

You can run functional or timing simulation to verify your design. This section describes the back-annotation process that must occur prior to timing simulation. It also describes the functional and timing simulation methods for both schematic and HDL-based designs.

Back-Annotation

Before timing simulation can occur, the physical design information must be translated and distributed back to the logical design. For FPGAs, this back-annotation process is done with a program called NetGen. For CPLDs, back-annotation is performed with the TSim Timing Simulator. These programs create a database, which translates the back-annotated information into a netlist format that can be used for timing simulation.

Back-Annotation Flow for FPGAs

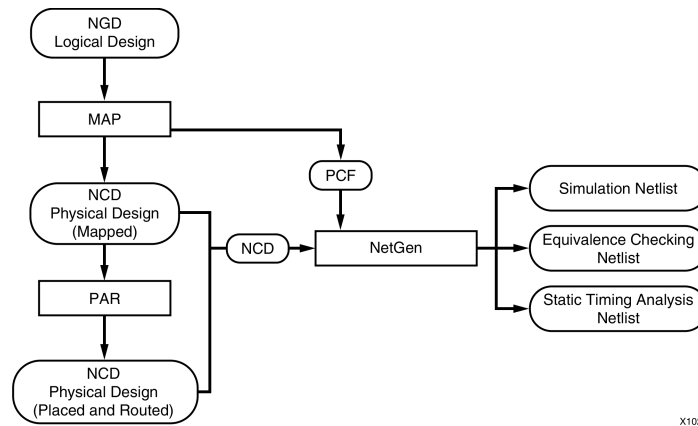

Back-Annotation (CPLDs)

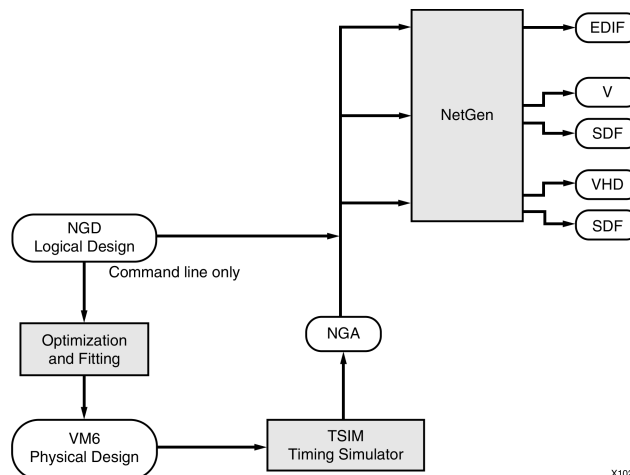

NetGen

NetGen is a command line program that distributes information about delays, setup and hold times, clock to out, and pulse widths found in the physical Native Circuit Description (NCD) design file back to the logical Native Generic Database (NGD) file and generates a Verilog or VHDL netlist for use with supported timing simulation, equivalence checking, and static timing analysis tools.

NetGen reads an NCD as input. The NCD file can be a mapped-only design, or a partially or fully placed and routed design. An NGM file, created by MAP, is an optional source of input. NetGen merges mapping information from the optional NGM file with placement, routing, and timing information from the NCD file.

Note NetGen reads an NGA file as input to generate a timing simulation netlist for CPLD designs.

See the [NetGen chapter](#) for detailed information.

Functional Simulation

Functional simulation determines if the logic in your design is correct before you implement it in a device. Functional simulation can take place at the earliest stages of the design flow. Because timing information for the implemented design is not available at this stage, the simulator tests the logic in the design using unit delays.

Note It is usually faster and easier to correct design errors if you perform functional simulation early in the design flow.

Timing Simulation

Timing simulation verifies that your design runs at the desired speed for your device under worst-case conditions. This process is performed after your design is mapped, placed, and routed for FPGAs or fitted for CPLDs. At this time, all design delays are known.

Timing simulation is valuable because it can verify timing relationships and determine the critical paths for the design under worst-case conditions. It can also determine whether or not the design contains set-up or hold violations.

Before you can simulate your design, you must go through the back-annotation process, above. During this process, NetGen creates suitable formats for various simulators.

HDL-Based Simulation

Xilinx® supports functional and timing simulation of HDL designs at the following points:

- Register Transfer Level (RTL) simulation, which may include the following:
 - Instantiated UNISIM library components
 - CORE Generator™ models
 - Dedicated blocks (SecureIP)
- Post-synthesis functional simulation with one of the following:
 - Gate-level UNISIM library components
 - CORE Generator models
 - Hard IP (SecureIP)
- Post-implementation back-annotated timing simulation with the following:
 - SIMPRIM library components
 - Hard IP (SecureIP)
 - Standard Delay Format (SDF) file

The following figure shows when you can perform functional and timing simulation:

Simulation Points for HDL Designs

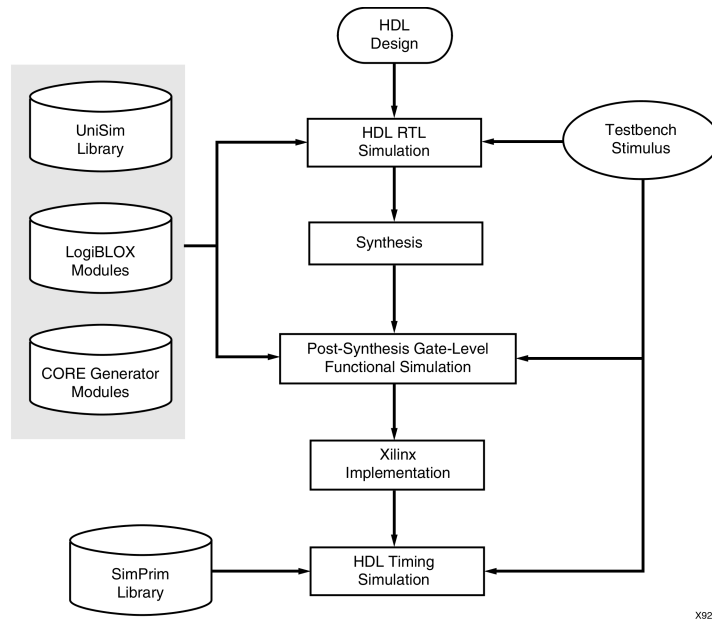

The three primary simulation points can be expanded to allow for two post-synthesis simulations. These points can be used if the synthesis tool cannot write VHDL or Verilog, or if the netlist is not in terms of UNISIM components. The following table lists all the simulation points available in the HDL design flow.

Five Simulation Points in HDL Design Flow

Simulation	UNISIM	SIMPRIM	SDF
RTL	X		
Post-Synthesis	X		
Functional Post-NGDBuild (Optional)		X	
Functional Post-MAP (Optional)		X	X
Post-Route Timing		X	X

These simulation points are described in the “Simulation Points” section of the *Synthesis and Simulation Design Guide (UG626)*.

The libraries required to support the simulation flows are described in detail in the “VHDL/Verilog Libraries and Models” section of the *Synthesis and Simulation Design Guide (UG626)*. The flows and libraries support close functional equivalence of initialization behavior between functional and timing simulations. This is due to the addition of methodologies and library cells to simulate Global Set/Reset (GSR) and Global 3-State (GTS) behavior.

Xilinx VHDL simulation supports the VITAL standard. This standard allows you to simulate with any VITAL-compliant simulator. Built-in Verilog support allows you to simulate with the Cadence Verilog-XL and compatible simulators. Xilinx HDL simulation supports all current Xilinx FPGA and CPLD devices. Refer to the *Synthesis and Simulation Design Guide (UG626)* for the list of supported VHDL and Verilog standards.

Static Timing Analysis (FPGAs Only)

Static timing allows you to determine path delays in your design. Following are the two major goals of static timing analysis:

- Timing verification

This is verifying that the design meets your timing constraints.

- Reporting

This is enumerating input constraint violations and placing them into an accessible file. You can analyze partially or completely placed and routed designs. The timing information depends on the placement and routing of the input design.

You can run static timing analysis using the Timing Reporter And Circuit Evaluator (TRACE) command line program. See the [TRACE](#) chapter for detailed information. You can also use the Timing Analyzer to perform this function. See the Help that comes with Timing Analyzer for additional information. Use either tool to evaluate how well the place and route tools met the input timing constraints.

In-Circuit Verification

As a final test, you can verify how your design performs in the target application. In-circuit verification tests the circuit under typical operating conditions. Because you can program your FPGA devices repeatedly, you can easily load different iterations of your design into your device and test it in-circuit. To verify your design in-circuit, download your design bitstream into a device with the appropriate Xilinx® cable.

Note For information about Xilinx cables and hardware, see the iMPACT online help.

Design Rule Checker (FPGAs Only)

Before generating the final bitstream, it is important to use the DRC option in BitGen to evaluate the NCD file for problems that could prevent the design from functioning properly. DRC is invoked automatically unless you use the `-d` option. See the [Physical Design Rule Check](#) chapter and the [BitGen](#) chapter for detailed information.

Probe

The Xilinx PROBE function in FPGA Editor provides real-time debug capability good for analyzing a few signals at a time. Using PROBE a designer can quickly identify and route any internal signals to available I/O pins without having to replace and route the design. The real-time activity of the signal can then be monitored using normal lab test equipment such as logic/state analyzers and oscilloscopes.

ChipScope™ ILA and ChipScope Pro

The ChipScope toolset was developed to assist engineers working at the PCB level. ChipScope ILA actually embeds logic analyzer cores into your design. These logic cores allow the user to view all the internal signals and nodes within an FPGA. Triggers are changeable in real-time without affecting the user logic or requiring recompilation of the user design.

FPGA Design Tips

The Xilinx® FPGA architecture is best suited for synchronous design. Strict synchronous design ensures that all registers are driven from the same time base with no clock skew. This section describes several tips for producing high-performance synchronous designs.

Design Size and Performance

Information about design size and performance can help you to optimize your design. When you place and route your design, the resulting report files list the number of CLBs, IOBs, and other device resources available. A first pass estimate can be obtained by processing the design through the MAP program.

If you want to determine the design size and performance without running automatic implementation software, you can quickly obtain an estimate from a rough calculation based on the Xilinx FPGA architecture.

PARTGen

This chapter describes PARTGen.

PARTGen Overview

PARTGen is a Xilinx® command line tool that displays architectural details about supported Xilinx devices.

Device Support

This program is compatible with the following device families:

- 7 series
- Spartan®-3, Spartan-3A, Spartan-3E, and Spartan-6
- Virtex®-4, Virtex-5, and Virtex-6
- CoolRunner™ XPLA3 and CoolRunner-II
- XC9500 and XC9500XL

PARTGen Input Files

PARTGen does not have any user input files.

PARTGen Output Files

PARTGen outputs two file types:

- [PARTGen Partlist Files](#) (ASCII and XML)
- [PARTGen Package Files](#) (ASCII)

PARTGen Partlist Files

PARTGen partlist files contain detailed information about architectures and devices, including supported synthesis tools. Partlist files are generated in both ASCII (.xct) and XML (.xml) formats.

The partlist file is automatically generated in XML format whenever a partlist file is created with the [PARTGen -p \(Generate Partlist and Package Files\)](#) or [PARTGen -v \(Generate Partlist and Package Files\)](#) options. No separate command line option is required.

The partlist file is a series of part entries. There is one entry for every part supported in the installed software. The following sections describe the information contained in the partlist file.

- PARTGen Partlist File Header
- PARTGen Partlist File Device Attributes for Both -p and -v Options
- PARTGen Partlist File Device Attributes for -v Option Only

PARTGen Partlist File Header

The first part of a PARTGen partlist file is a header for the entry.

```
part architecture family partname diename packagefilename
```

PARTGen Partlist File Header Example for XC6VLX550TFF1759 Device

```
partVIRTEX XC6VLX550Tff1759 NA.die xc6vlx550tff1759.pkg
```

PARTGen Partlist File Device Attributes for both -p and -v Options

The following PARTGen partlist file device attributes display for both the -p and -v command line options.

- CLB row and column sizes
NCLBROWS=# NCLBCOLS=#
- Sub-family designation
STYLE=sub_family (For example, STYLE = Virtex6)
- Input registers
IN_FF_PER_IOB=#
- Output registers
OUT_FF_PER_IOB=#
- Number of pads per row and per column
NPADS_PER_ROW=# NPADS_PER_COL=#
- Bitstream information
 - Number of frames: NFRAMES=#
 - Number bits/frame: NBITSPERFRAME=#
- Stepping levels supported: STEP=#
- I/O Standards

For each I/O standard, PARTGen now reports all properties in a parsable format. This allows third party tools to perform complete I/O banking design rules checking (DRC).

The following information has been added to the partlist.xct and partlist.xml output for each available I/O standard:

```
IOSTD_NAME: LVTTL \
  IOSTD_DRIVE: 12 2 4 6 8 16 24 \
  IOSTD_SLEW: SLOW FAST \
  IOSTD_DIRECTION: INPUT=1 OUTPUT=1 BIDIR=1 \
  IOSTD_INPUTTERM: NONE \
  IOSTD_OUTPUTTERM: NONE \
  IOSTD_VCCO: 3.300000 \
  IOSTD_VREF: 100.000000 \
  IOSTD_VRREQUIRED: 0 \
  IOSTD_DIFFTERMREQUIRED: 0 \
```

For IOSTD_DRIVE and IOSTD_SLEW, the default values are reported first in the list. For true/false values:

- 1 indicates true
- 0 indicates false

A value of 100.000000 for IOSTD_VREF indicates that this keyword is undefined for this standard.

- SO and WASSO Calculations

PARTGen now exports I/O standard and device properties in a machine readable format. This allows third party tools to perform SSO and WASSO calculations.

SSO data consists of two parts:

- The maximum number of SSOs allowed per power/ground pair
- The number of power/ground pairs for a given bank.

This data has been added to the `partlist.xct` and `partlist.xml` output for each device/package combination. The number of power/ground pairs is listed by bank number:

```
PER_BANK_PWRGND_PAIRS\
  BANK_SSO NAME=0 TYPE=INT 1\
  BANK_SSO NAME=1 TYPE=INT 1\
  BANK_SSO NAME=2 TYPE=INT 1\
  BANK_SSO NAME=3 TYPE=INT 1\
  BANK_SSO NAME=4 TYPE=INT 1\
  BANK_SSO NAME=5 TYPE=INT 5\
  BANK_SSO NAME=6 TYPE=INT 5\
  BANK_SSO NAME=7 TYPE=INT 3\
  BANK_SSO NAME=8 TYPE=INT 3\
```

The maximum number of SSOs allowed per power/ground pair is reported using the SSO_PER_IOSTD keyword. Each entry reflects the maximum number of SSOs (column 6) for the I/O standard (column 3), drive strength (column 2), and slew rate (column 4) shown.

For example, LVTTTL, with drive strength 12 and slew rate SLOW, has a maximum of 15 SSOs per power/ground pair.

```
MAX_SSO_PER_IOSTD_PER_BANK\
  IOSTD_SSO DRIVE=12 NAME=LVTTTL SLEW=SLOW TYPE=INT 15\
  IOSTD_SSO DRIVE=12 NAME=LVTTTL SLEW=FAST TYPE=INT 10\
  IOSTD_SSO DRIVE=2 NAME=LVTTTL SLEW=SLOW TYPE=INT 68\
  IOSTD_SSO DRIVE=2 NAME=LVTTTL SLEW=FAST TYPE=INT 40\
  IOSTD_SSO DRIVE=4 NAME=LVTTTL SLEW=SLOW TYPE=INT 41\
  IOSTD_SSO DRIVE=4 NAME=LVTTTL SLEW=FAST TYPE=INT 24\
  IOSTD_SSO DRIVE=6 NAME=LVTTTL SLEW=SLOW TYPE=INT 29\
  IOSTD_SSO DRIVE=6 NAME=LVTTTL SLEW=FAST TYPE=INT 17\
  IOSTD_SSO DRIVE=8 NAME=LVTTTL SLEW=SLOW TYPE=INT 22\
  IOSTD_SSO DRIVE=8 NAME=LVTTTL SLEW=FAST TYPE=INT 13\
  IOSTD_SSO DRIVE=16 NAME=LVTTTL SLEW=SLOW TYPE=INT 11\
  IOSTD_SSO DRIVE=16 NAME=LVTTTL SLEW=FAST TYPE=INT 8\
  IOSTD_SSO DRIVE=24 NAME=LVTTTL SLEW=SLOW TYPE=INT 7\
  IOSTD_SSO DRIVE=24 NAME=LVTTTL SLEW=FAST TYPE=INT 5\
```

- Device global, local and regional clocking properties

For each type of clock available on the device, PARTGen now reports:

- Which pin number can behave as which clock type
- Which I/O can be driven by this clock pin

This allows third party tools to assign pins on Xilinx® packages without violating clocking rules.

The following information has been added to the `partlist.xct` and `partlist.xml` output for each clock region of a device:

```
DEVICE_CLKRGN\
  NUM_CLKRGN TYPE=INT 8\
  NUM_CLKRGN_ROW TYPE=INT 4\
  NUM_CLKRGN_COL TYPE=INT 2\
  CLKRGN TYPE=STRING X0Y0\
  CLK_CAPABLE_SCOPE\
  UNASSOCIATED_PINS\
  NUM_UNBONDED_PINS TYPE=INT 2\
  UNBONDED_PIN_LIST TYPE=STRINGLIST T17R17\
  UNBONDED_IOB_LIST TYPE=STRINGLIST IOB_X0Y15IOB_X0Y17\
  ASSOCIATED_BUFIO\
  NUM_BUFIO TYPE=INT 4\
  BUFIO_SITES TYPE=STRINGLIST BUFIO_X0Y0BUFIO_X0Y1BUFIO_X1Y0BUFIO_X1Y1\
  ASSOCIATED_BUFR\
  NUM_BUFR TYPE=INT 2\
  BUFRO_SITES TYPE=STRINGLIST BUFRO_X0Y0BUFR_X0Y1\
  ASSOCIATED_PINS\
  NUM_BONDED_PINS TYPE=INT 39\
  BONDED_PIN_LIST TYPE=STRINGLIST V18V17W17Y17W19W18U17U16V20V19U15T15U19U18T18\
  T17R18R17T20T19R16R15R20R19W8W9Y9Y10W7Y7W10W11W6Y6Y11Y12W5Y5W12\
  BONDED_IOB_LIST TYPE=STRINGLIST IOB_X0Y0IOB_X0Y1IOB_X0Y2IOB_X0Y3IOB_X0Y4IOB_X0Y5IOB_\
  X0Y6IOB_X0Y7IOB_X0Y8IOB_X0Y9IOB_X0Y10IOB_X0Y11IOB_X0Y12IOB_X0Y13IOB_X0Y14IOB_\
  X0Y15IOB_X0Y16IOB_X0Y17IOB_X0Y18IOB_X0Y19IOB_X0Y22IOB_X0Y23IOB_X0Y24IOB_X0Y25IOB_\
  X1Y16IOB_X1Y17IOB_X1Y18IOB_X1Y19IOB_X1Y20IOB_X1Y21IOB_X1Y22IOB_X1Y23IOB_X1Y24IOB_\
  X1Y25IOB_X1Y26IOB_X1Y27IOB_X1Y28IOB_X1Y29IOB_X1Y30\
```

PARTGen Partlist File Device Attributes for `partgen -v` Option Only

The following PARTGen partlist file device attributes display for the `-v` command line option only.

- Number of IOBS in device
NIOBS=#
- Number of bonded IOBS
NBIOBS=#
- Slices per CLB: SLICES_PER_CLB=#
For slice-based architectures. For non-slice based architectures, assume one slice per CLB.
- Flip-flops for each slice
FFS_PER_SLICE=#
- Latches for each slice
CAN BE LATCHES={TRUE|FALSE}
- Number of DCMs, PLLs and/or MMCMs
- LUTs in a slice: LUT_NAME=name LUT_SIZE=#
- Number of global buffers: NUM_GLOBAL_BUFFERS=#
(The number of places where a buffer can drive a global clock combination)
- Block RAM

```
NUM_BLK_RAMS=# BLK_RAM_COLS=# BLK_RAM_COL0=# BLK_RAMCOL1=#
BLK_RAM_COL2=# BLK_RAM_COL_3=# BLK_RAM_SIZE=4096x1
BLK_RAM_SIZE=2048x2 BLK_RAM_SIZE=512x8 BLK_RAM_SIZE=256x16
```

Block RAM locations are given with reference to CLB columns. In the following example, Block RAM 5 is positioned in CLB column 32.

```
NUM_BLK_RAMS=10 BLK_RAM_COL_5=32 BLK_RAM_SIZE=4096X1
```

- Select RAM

```
NUM_SEL_RAMS=# SEL_RAM_SIZE=#X#
```

- Select Dual Port RAM

```
SEL_DP_RAM= { TRUE | FALSE }
```

This field indicates whether the select RAM can be used as a dual port ram. The assumption is that the number of addressable elements is reduced by half, that is, the size of the select RAM in Dual Port Mode is half that indicated by SEL_RAM_SIZE.

- Speed grade information: SPEEDGRADE=#

Delays information no longer appears in the XCT and XML partlist files. Delay information can be obtained using Speedprint. For more information, see the [Speedprint](#) chapter in this guide.

- Maximum LUT constructed in a slice

```
MAX_LUT_PER_SLICE=# (From all the LUTs in the slice)
```

- Max LUT constructed in a CLB: MAX_LUT_PER_CLB=#

This field describes how wide a LUT can be constructed in the CLB from the available LUTs in the slice.

- Number of internal tristate buffers in a device

```
NUM_TBUFS PER ROW=#
```

- If available on a particular device or package, PartGen reports:

```
NUM_PPC=#
NUM_GT=#
NUM_MONITOR=#
NUM_DPM=#
NUM_PMCD=#
NUM_DSP=#
NUM_FIFO=#
NUM_EMAC=#
NUM_MULT=#
```

PARTGen Package Files

PARTGen package files are ASCII formatted files that correlate IOBs with output pin names. Package files are in XACT package format, which is a set of columns of information about the pins of a particular package. The **-p** (terse) command line option generates a three column entry describing the pins. The **-v** (verbose) command line option adds six more columns describing the pins. The following sections describe the information contained in the package files.

- PARTGen Package Files With the -p Option
- PARTGen Package Files With the -v Option

PARTGen Package Files Using the -p Option

The **partgen -p** command line option generates package files and displays a three-column entry describing the pins. See the following table.

Package Files Column Descriptions

Column	Contents	Description
1	pin (user accessible pin) or pkgpin (dedicated pin)	Contains either pin (user accessible pin) or pkgpin (dedicated pin)
2	pin name	For user accessible pins, the name of the pin is the bonded pad name associated with an IOB on the device, or the name of a multi-purpose pin. For dedicated pins, the name is either the functional name of the pin, or no connection (N.C.)
3	package pin	Specifies the package pin

For example, the command `partgen -p xc6vlx75t` generates the following package files:

- `xc6vlx75tff484.pkg`
- `xc6vlx75tff784.pkg`

Package File Example Using the -p Option

Following is an example of a portion of the package file for an `xc6vlx75tff484` package:

```
package xc6vlx75tff484
pin IPAD_X1Y25 G3
pin IPAD_X0Y31 M11
pin IOB_X0Y39 M18
.
.
.
```

PARTGen Package Files Using the -v Option

The `partgen -v` command line option generates package files and displays a nine-column entry describing the pins. See the following table.

Package Files Column Descriptions

Column	Contents	Description
1	pin (user accessible pin) or pkgpin (dedicated pin)	Contains either pin (user accessible pin) or pkgpin (dedicated pin)
2	pin name	For user accessible pins, the name of the pin is the bonded pad name associated with an IOB on the device, or the name of a multi-purpose pin. For dedicated pins, the name is either the functional name of the pin, or no connection (N.C.)
3	package pin	Specifies the package pin
4	VREF BANK	A positive integer associated with the relative bank, or 1 for no bank association
5	VCCO BANK	A positive integer associated with the relative bank, or 1 for no bank association
6	function name	Consists of a string indicating how the pin is used. If the pin is dedicated, then the string will indicate a specific function. If the pin is a generic user

Column	Contents	Description
		pin, the string is "IO". If the pin is multipurpose, an underscore-separated set of characters will make up the string
7	CLB	Closest CLB row or column to the pin, and appears in the form R[0-9]C[0-9] or x[0-9]y[0-9]
8	LVDS IOB	A string for each pin associated with a LVDS IOB. The string consists of an index and the letter M or S. Index values will go from 0 to the number of LVDS pairs. The value for a non-LVDS pin defaults to N.A.
9	flight-time data	Flight-time data in units of microns. If no flight-time data is available, this column contains N/A.

PARTGen Verbose Pin Descriptors Example

Following are examples of the verbose pin descriptors in PARTGen.

```
package xc6vlx75tff484
# PartGen L.44
#      pad          pin      vref vcco  function          nearest diff.  tracelength
#      name         name    bank bank  name             CLB   pair   (um)
pin   IPAD_X1Y25    G3      -1  -1  MGTRXP0_115      N.A.  N.A.  8594
pin   IPAD_X0Y31    M11     0   0   VN_0             N.A.  N.A.  1915
pin   IOB_X0Y39     M18     14  14  IO_L0P_14        X0Y38 0M    4111
pin   IOB_X0Y38     N18     14  14  IO_L0N_14        X0Y38 0S    3390
```

PARTGen Syntax

The PARTGen command line syntax is:

partgen *options*

options can be any number of the options listed in [PARTGen Command Line Options](#). Enter options in any order, preceded them with a dash (minus sign on the keyboard) and separate them with spaces.

Both package and partlist files can be generated using the **partgen -p** (terse) and **partgen -v** (verbose) options.

- **partgen -p** generates a three column entry describing the pins.
- **partgen -v** adds six more columns describing the pins.

PARTGen Command Line Options

This section describes the PARTGen command line options.

- [PARTGen -arch](#) (Output Information for Specified Architecture)
- [PARTGen -i](#) (Output List of Devices, Packages, and Speeds)
- [PARTGen -intstyle](#) (Specify Integration Style)
- [PARTGen -nopkgfile](#) (Generate No Package File)
- [PARTGen -p](#) (Generate Partlist and Package Files)
- [PARTGen -v](#) (Generate Partlist and Package Files)

-arch (Output Information for Specified Architecture)

This option outputs a list of devices, packages, and speeds for a specified architecture.

Syntax

-arch *architecture_name*

Allowed values for *architecture_name* are:

- acr2 (for Automotive CoolRunner™-II)
- aspartan3 (for Automotive Spartan®-3)
- aspartan3a (for Automotive Spartan-3A)
- aspartan3adsp (for Automotive Spartan-3A DSP)
- aspartan3e (for Automotive Spartan-3E)
- aspartan6 (for Automotive Spartan-6)
- kintex7 (for Kintex™-7)
- kintex7l (for Kintex-7 Lower Power)
- qvirtex4 (for QPro™ Virtex®-4 Rad Tolerant)
- qvirtex4 (for QPro Virtex-4 Hi-Rel)
- qvirtex5 (for QPro Virtex-5 Hi-Rel)
- qspartan6 (for QPro Spartan-6 Hi-Rel)
- qvirtex6 (for QPro Virtex-6 Hi-Rel)
- spartan3 (for Spartan-3)
- spartan3a (for Spartan-3A)
- spartan3adsp (for Spartan-3A DSP)
- spartan3e (for Spartan-3E)
- spartan6 (for Spartan-6)
- virtex4 (for Virtex-4)
- virtex5 (for Virtex-5)
- virtex6 (for Virtex-6)
- virtex6l (for Virtex-6 Lower Power)
- virtex7 (for Virtex-7)
- virtex7l (for Virtex-7 Lower Power)
- xa9500xl (for Automotive XC9500XL)
- xbr (for CoolRunner-II)
- xc9500 (for XC9500)
- xc9500xl (for XC9500XL)
- xpla3 (for CoolRunner XPLA3)

-i (Output List of Devices, Packages, and Speeds)

This option outputs a list of devices, packages, and speeds for every installed device.

Syntax

-i

-intstyle (Integration Style)

This option limits screen output, based on the integration style that you are running, to warning and error messages only.

Syntax

```
-intstyle ise|xflow|silent
```

When using **-intstyle**, one of three modes must be specified:

- **-intstyle ise** indicates the program is being run as part of an integrated design environment.
- **-intstyle xflow** indicates the program is being run as part of an integrated batch flow.
- **-intstyle silent** limits screen output to warning and error messages only.

Note **-intstyle** is automatically invoked when running in an integrated environment such as Project Navigator or XFLOW.

-nopkgfile (Generate No Package File)

This option cancels the production of the package files when the **-p** and **-v** options are used. The **-nopkgfile** option allows you to bypass creating package files.

Syntax

```
-nopkgfile
```

-p (Generate Partlist and Package Files)

This command line option generates:

- Partlist files in ASCII (.xct) and XML (.xml) formats
- Package files in ASCII (.pkg) format

Syntax

```
-p name
```

Valid entries for *name* include:

- architectures
- devices
- parts

All files are placed in the working directory.

If an architecture, device, or part is not specified with this option, detailed information for every installed device is submitted to the `partlist.xct` file. For more information, see [PARTGen Partlist Files](#).

The **-p** option generates more detailed information than the **-arch** option, but less information than the **-v** option. The **-p** and **-v** options are mutually exclusive. You can specify one or the other but not both. For more information see:

- [PARTGen Package Files](#)
- [PARTGen Partlist Files](#)

Examples of Valid Command Line Entries

Name	Example Command Line Entry
architecture	<code>-p virtex5</code>
device	<code>-p xc5v1x110t</code>
part	<code>-p xc5v1x110tff1136</code>

-v (Generate Partlist and Package Files)

This command line option generates:

- Partlist files in ASCII (.xct) and XML (.xml) formats
- Package files in ASCII (.pkg) format

Syntax

`-v name`

Valid entries for *name* include:

- architectures
- devices
- parts

If no architecture, device, or part is specified with the `-v` option, information for every installed device is submitted to the partlist file. For more information, see [PARTGen Partlist Files](#).

The `-v` option generates more detailed information than the `-p` option. The `-p` and `-v` options are mutually exclusive. You can specify one or the other but not both. For more information, see:

- [PARTGen Package Files](#)
- [PARTGen Partlist Files](#)

Examples of Command Line Entries for the -v Option

Name	Example Command Line Entry
architecture	<code>partgen -v virtex6</code>
device	<code>partgen -v xc5v1x110t</code>
part	<code>partgen -v xc5v1x110tff1136</code>

NetGen

This chapter describes the NetGen program, which generates netlists for use with third-party tools.

NetGen Overview

NetGen is a command line executable that reads Xilinx® design files as input, extracts data from the design files, and generates netlists that are used with supported third-party simulation, equivalence checking, and static timing analysis tools.

NetGen can take an implemented design file and write out a single netlist for the entire design, or multiple netlists for each module of a hierarchical design. Individual modules of a design can be simulated on their own, or together at the top-level. Modules identified with the KEEP_HIERARCHY attribute are written as user-specified Verilog, VHDL, and SDF netlists with the `-mhf (Multiple Hierarchical Files)` option. See [Preserving and Writing Hierarchy Files](#) for additional information.

NetGen Flows

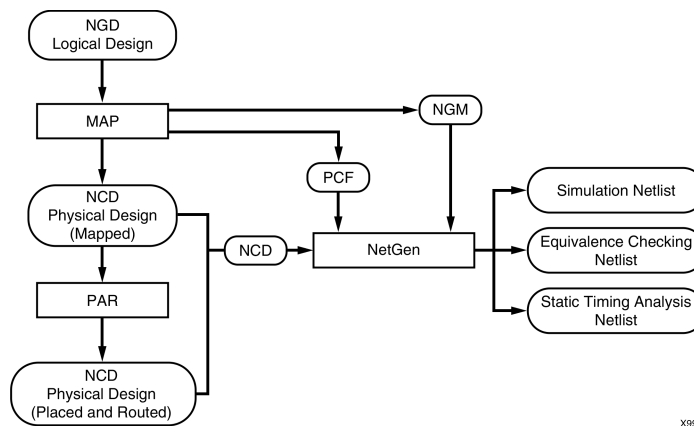

NetGen can be described as having three fundamental flows: simulation, equivalency checking, and third-party static timing analysis. This chapter contains flow-specific sections that detail the use and features of NetGen support flows and describe any sub-flows. For example, the simulation flow includes two flows types: functional simulation and timing simulation.

Each flow-specific section includes command line syntax, input files, output files, and available command line options for each NetGen flow.

NetGen syntax is based on the type of NetGen flow you are running. For details on NetGen flows and syntax, refer to the flow-specific sections that follow.

Valid netlist flows are:

- **-sim (Simulation)** - generates a simulation netlist for functional simulation or timing simulation. For this netlist type, you must specify the output file type as Verilog or VHDL with the **-ofmt** option.

```
netgen -sim [options]
```

- **-ecn (Equivalence)** - generates a Verilog-based equivalence checking netlist. For this netlist type, you must specify a tool name after the **-ecn** option. Possible tool names for this netlist type are **conformal** or **formality**.

```
netgen -ecn conformal | formality [options]
```

- **-sta (Static Timing Analysis)** - generates a Verilog netlist for static timing analysis.

```
netgen -sta [options]
```

NetGen supports the following flow types:

- Functional Simulation for FPGA and CPLD designs
- Timing Simulation for FPGA and CPLD designs
- Equivalence Checking for FPGA designs
- Static Timing Analysis for FPGA designs

The flow type that NetGen runs is based on the input design file (NGC, NGD, or NCD). The following table shows the output file types, based on the input design files:

NetGen Output Files

Input Design File	Output File Type
NGC	UNISIM-based functional simulation netlist
NGD	SIMPRIM-based functional netlist
NGA from CPLD	SIMPRIM-based netlist, along with a full timing SDF file.
NCD from MAP	SIMPRIM-based netlist, along with a partial timing SDF file
NCD from PAR	SIMPRIM-based netlist, along with a full timing SDF file

NetGen Device Support

This program is compatible with the following device families:

- 7 series
- Spartan®-3, Spartan-3A, Spartan-3E, and Spartan-6
- Virtex®-4, Virtex-5, and Virtex-6
- CoolRunner™ XPLA3 and CoolRunner-II
- XC9500 and XC9500XL

NetGen Simulation Flow

Within the NetGen Simulation flow, there are two sub-flows: functional simulation and timing simulation. The functional simulation flow may be used for UNISIM-based or SIMPRIM-based netlists, based on the input file. An input NGC file will generate a UNISIM-based netlist for functional simulation. An input NGD file will generate a SIMPRIM-based netlist for functional simulation. Similarly, timing simulation can be broken down further to post-map timing simulation and post-par timing simulation, both of which use SIMPRIM-based netlists.

Note NetGen does not list LOC parameters when an NGD file is used as input. In this case, UNPLACED is reported as the default value for LOC parameters.

Options for the NetGen Simulation flow (and sub-flows) can be viewed by running `netgen -h sim` from the command line.

NetGen Functional Simulation Flow

This section describes the functional simulation flow, which is used to translate NGC and NGD files into Verilog or VHDL netlists.

When you enter an NGC file as input on the NetGen command line, NetGen invokes the functional simulation flow to produce a UNISIM-based netlist. Similarly, when you enter an NGD file as input on the NetGen command line, NetGen invokes the functional simulation flow to produce a SIMPRIM-based netlist. You must also specify the type of netlist you want to create: Verilog or VHDL.

The Functional Simulation flow uses the following files as input:

- **NGC** - This file output by XST is used to create a UNISIM-based netlist suitable for using with IP Cores and performing post-synthesis functional simulation.
- **NGD** - This file output by NGDBuild contains a logical description of the design and is used to create a SIMPRIM-based netlist.

Functional Simulation for UNISIM-based Netlists

For XST users, the output NGC file can be entered on the command line. For third-party synthesis tool users, you must first use the `ngcbuild` command to convert all of the design netlists to a single NGC file, which NetGen takes as input.

The following command reads the top-level EDIF netlist and converts it to an NGC file:

```
ngcbuild [options] top_level_netlist_file output_ngc_file
```

Output files for NetGen Functional Simulation

- **V file** - A IEEE 1364-2001 compliant Verilog HDL file that contains netlist information obtained from the input design files. This file is a simulation model. It cannot be synthesized, and can only be used for simulation.
- **VHD file** - A VHDL IEEE 1076.4 VITAL-2000 compliant VHDL file that contains netlist information obtained from the input design files. This file is a simulation model. It cannot be synthesized, and can only be used for simulation.

Syntax for NetGen Functional Simulation

The following command runs the NetGen Functional Simulation flow:

```
netgen -ofmt [verilog|vhdl] [options] input_file [.ngd|.ngc]
```

`-ofmt` specifies the output netlist format (verilog or vhdl).

options is one or more of the options listed in the [Options for NetGen Simulation Flow](#) section. In addition to common options, this section also contains Verilog and VHDL-specific options.

input_file is the input file name. If an NGD file is used, the `.ngd` extension must be specified.

NetGen Timing Simulation Flow

This section describes the NetGen Timing Simulation flow, which is used for timing verification on FPGA and CPLD designs. For FPGA designs, timing simulation is done after PAR, but may also be done after MAP if only component delay and no route delay information is needed. When performing timing simulation, you must specify the type of netlist you want to create: Verilog or VHDL. In addition to the specified netlist, NetGen also creates an SDF file as output. The output Verilog and VHDL netlists contain the functionality of the design and the SDF file contains the timing information for the design.

Input file types depend on whether you are using an FPGA or CPLD design. Please refer to [FPGA Timing Simulation](#) and [CPLD Timing Simulation](#) below for design-specific information, including input file types.

FPGA Timing Simulation

You can verify the timing of an FPGA design using the NetGen Timing Simulation flow to generate a Verilog or VHDL netlist and an SDF file. The figure below illustrates the NetGen Timing Simulation flow using an FPGA design.

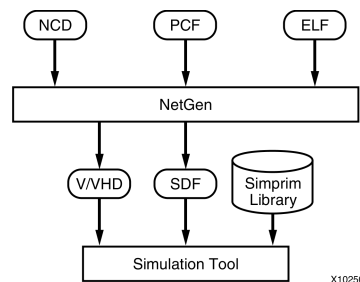

The FPGA Timing Simulation flow uses the following files as input:

- **NCD** - This physical design file may be mapped only, partially or fully placed, or partially or fully routed.
- **PCF (optional)** - This is a physical constraints file. If prorated voltage or temperature is applied to the design, the PCF must be included to pass this information to NetGen. See [-pcf \(PCF File\)](#) for more information.
- **ELF (MEM) (optional)** - This file populates the Block RAMs specified in the `.bmm` file. See [-bd \(Block RAM Data File\)](#) for more information.

The FPGA Timing Simulation flow creates the following output files:

- **SDF file** - This SDF 3.0 compliant standard delay format file contains delays obtained from the input design files.
- **V file** - This is a IEEE 1364-2001 compliant Verilog HDL file that contains the netlist information obtained from the input design files. This file is a simulation model. It cannot be synthesized, and can only be used for simulation.
- **VHD file** - This VHDL IEEE 1076.4 VITAL-2000 compliant VHDL file contains the netlist information obtained from the input design files. This file is a simulation model. It cannot be synthesized, and can only be used for simulation.

CPLD Timing Simulation

You can use the NetGen Timing Simulation flow to verify the timing of a CPLD design after it is implemented using CPLDFit and the delays are annotated using the `-tsim` option. The input file is the annotated NGA file from the TSIM program.

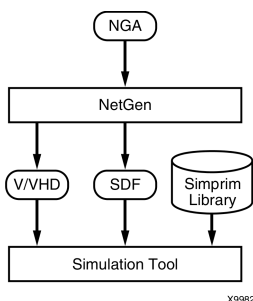

Note See the [CPLDFit](#) chapter and the [TSIM](#) chapter for additional information.

The CPLD Timing Simulation flow uses the following files as input:

NGA file - This native generic annotated file is a logical design file from TSIM that contains Xilinx® primitives. See the [TSIM](#) chapter for additional information.

The NetGen Simulation Flow creates the following output files:

- **SDF file** - A standard delay format file that contains delays obtained from the input NGA file.
- **V file** - An IEEE 1364-2001 compliant Verilog HDL file that contains netlist information obtained from the input NGA file. This file is a simulation model. It cannot be synthesized, and can only be used for simulation.
- **VHD file** - A VHDL IEEE 1076.4 VITAL-2000 compliant VHDL file that contains netlist information obtained from the input NGA file. This file is a simulation model. It cannot be synthesized, and can only be used for simulation.

Syntax for NetGen Timing Simulation Flow

The following command runs the NetGen Timing Simulation flow:

```
netgen -sim -ofmt [verilog|vhdl] [options] input_file [.ncd]
```

verilog or **vhdl** is the output netlist format that you specify with the required `-ofmt` option.

options is one or more of the options listed in the [Options for NetGen Simulation Flow](#) section. In addition to common options, this section also contains Verilog and VHDL-specific options.

input_file is the input file name.

To get help on the command line for NetGen Timing Simulation commands, type **netgen -h sim**.

Options for NetGen Simulation Flow

This section describes the supported NetGen command line options for timing simulation.

- [-aka](#) (Write Also-Known-As Names as Comments)
- [-bd](#) (Block RAM Data File)
- [-bx](#) (Block RAM Init Files Directory)
- [-dir](#) (Directory Name)
- [-fn](#) (Control Flattening a Netlist)
- [-gp](#) (Bring Out Global Reset Net as Port)
- [-insert_pp_buffers](#) (Insert Path Pulse Buffers)
- [-intstyle](#) (Integration Style)
- [-mhf](#) (Multiple Hierarchical Files)
- [-ofmt](#) (Output Format)
- [-pcf](#) (PCF File)
- [-s](#) (Speed)
- [-sim](#) (Generate Simulation Netlist)
- [-tb](#) (Generate Testbench Template File)
- [-ti](#) (Top Instance Name)
- [-tp](#) (Bring Out Global 3-State Net as Port)
- [-w](#) (Overwrite Existing Files)

-aka (Write Also-Known-As Names as Comments)

This option includes original user-defined identifiers as comments in the netlist. This option is useful if user-defined identifiers are changed because of name legalization processes in NetGen.

Syntax

-aka

-bd (Block RAM Data File)

This option specifies the path and file name of the file used to populate the Block RAM instances specified in the `.bmm` file. Data2MEM can determine the **ADDRESS_BLOCK** in which to place the data from address and data information in the `.elf` (from EDK) or `.mem` file. You can include more than one instance of **-bd**.

Optionally, you can specify **tag** *tagname*, in which case only the address spaces with the same name in the `.bmm` file are used for translation, and data outside of the *tagname* address spaces are ignored.

Syntax

-bd *filename* [`.elf` | `.mem`] [**tag** *tagname*]

Note When using this option, you must also use [-bx](#) (Block RAM Init Files Directory) to specify the directory into which the Block RAM Initialization files will be written.

-bx (Block RAM Init Files Directory)

This option specifies the directory into which the Block RAM Initialization files will be written.

Syntax

`-bx bram_output_dir`

-dir (Directory Name)

This option specifies the directory for the output files.

Syntax

`-dir directory_name`

-fn (Control Flattening a Netlist)

This option outputs a flattened netlist. A flat netlist does not include any design hierarchy.

Syntax

`-fn`

-gp (Bring Out Global Reset Net as Port)

This option causes NetGen to bring out the global reset signal (which is connected to all flip-flops and latches in the physical design) as a port on the top-level design module. Specifying the port name allows you to match the port name you used in the front end.

This option is used only if the global reset net is not driven. For example, if you include a STARTUP_VIRTEX5 component in a Virtex®-5 design, you should not enter the `-gp` option because the STARTUP_VIRTEX5 component drives the global reset net.

Syntax

`-gp port_name`

Note Do not use GR, GSR, PRLD, PRELOAD, or RESET as port names, because these are reserved names in the Xilinx® software. This option is ignored by UNISIM-based flows, which use an NGC file as input.

-insert_pp_buffers (Insert Path Pulse Buffers)

This option controls whether path pulse buffers are inserted into the output netlist to eliminate pulse swallowing. Pulse swallowing is seen on signals in back-annotated timing simulations when the pulse width is shorter than the delay on the input port of the component. For example, if a clock of period 5 ns (2.5 ns high/2.5 ns low) is propagated through a buffer, but in the SDF, the PORT or IOPATH delay for the input port of that buffer is greater than 2.5 ns, the output will be unchanged in the waveform window (e.g., if the output was "X" at the start of simulation, it will remain at "X").

Note This option is available when the input is an NCD file.

Syntax

`-insert_pp_buffers true|false`

By default this command is set to false.

-intstyle (Integration Style)

This option limits screen output, based on the integration style that you are running, to warning and error messages only.

Syntax

```
-intstyle ise|xflow
```

When using **-intstyle**, one of three modes must be specified:

- **-intstyle ise** indicates the program is being run as part of an integrated design environment.
- **-intstyle xflow** indicates the program is being run as part of an integrated batch flow.

Note **-intstyle** is automatically invoked when running in an integrated environment such as Project Navigator or XFLOW.

-mhf (Multiple Hierarchical Files)

This option is used to write multiple hierarchical files. One hierarchical file will be written for each module that has the KEEP_HIERARCHY attribute.

Note See [Preserving and Writing Hierarchy Files](#) for additional information.

Syntax

```
-mhf
```

-ofmt (Output Format)

This is a required option that specifies the output format for netlists (either Verilog or VHDL).

Syntax

```
-ofmt verilog|vhdl
```

-pcf (PCF File)

This option lets you specify a Physical Constraints File (PCF) as input to NetGen. You only need to specify a PCF file if you use prorating constraints (temperature and/or voltage).

Temperature and voltage constraints and prorated delays are described in the [Constraints Guide \(UG625\)](#).

Syntax

```
-pcf pcf_file.pcf
```

-s (Change Speed)

This option instructs NetGen to annotate the device speed grade you specify to the netlist.

Syntax

```
-s speed grade|min
```

speed grade can be entered with or without the leading dash. For example, both **-s 3** and **-s -3** are allowed.

Some architectures support the **-s min** option, which instructs NetGen to annotate a process minimum delay, rather than a maximum worst-case to the netlist. Use the Speedprint or PARTGen utility programs in the software to determine whether process minimum delays are available for your target architecture. See the [PARTGen chapter](#) for additional information.

Settings made with this option override prorated timing parameters in the Physical Constraints File (PCF). If you use `-s min`, all fields in the resulting SDF file (MIN:TYP:MAX) are set to the process minimum value.

-sim (Generate Simulation Netlist)

This option writes a simulation netlist. This is the default option for NetGen.

Syntax

`-sim`

-tb (Generate Testbench Template File)

This option generates a testbench file with a `.tv` extension for verilog, and `.tvhd` extension for vhd. It is a ready-to-use Verilog or VHDL template file, based on the input NCD file. The type of template file (Verilog or VHDL) is specified with the `-ofmt` option.

Syntax

`-tb`

-ti (Top Instance Name)

This option specifies a user instance name for the design under test in the testbench file created with the `-tb` option.

Syntax

`-ti top_instance_name`

-tp (Bring Out Global 3-State Net as Port)

This option causes NetGen to bring out the global 3-state signal (which forces all FPGA outputs to the high-impedance state) as a port on the top-level design module or output file. Specifying the port name allows you to match the port name you used in the front-end.

This option is only used if the global 3-state net is not driven.

Note Do not use the name of any wire or port that already exists in the design, because this causes NetGen to issue an error. This option is ignored in UNISIM-based flows, which use an NGC file as input.

Syntax

`-tp port_name`

-w (Overwrite Existing Files)

This option causes NetGen to overwrite the netlist (`.vhd` or `.v`) file if it exists. By default, NetGen does not overwrite the netlist file.

Note All other output files are automatically overwritten.

Syntax

`-w`

Verilog-Specific Options for Functional and Timing Simulation

This section describes the Verilog-specific command line options for timing simulation.

- `-insert_glbl` (Insert `glbl.v` Module)
- `-ism` (Include SimPrim Modules in Verilog File)
- `-ne` (No Name Escaping)
- `-pf` (Generate PIN File)
- `-sdf_anno` (Include `$sdf_annotate`)
- `-sdf_path` (Full Path to SDF File)
- `-shm` (Write `$shm` Statements in Test Fixture File)
- `-ul` (Write `uselib` Directive)
- `-vcd` (Write `$dump` Statements In Test Fixture File)

`-insert_glbl` (Insert `glbl.v` Module)

This option tells NetGen to include the `glbl.v` module in the output Verilog simulation netlist.

Syntax

```
-insert_glbl [true|false]
```

The default value of this option is true.

If you set this option to false, the output Verilog netlist will not contain the `glbl.v` module. For more information on `glbl.v`, see the [Synthesis and Simulation Design Guide \(UG626\)](#)

Note If the `-mhf` (multiple hierarchical files) option is used, `-insert_glbl` cannot be set to true.

`-ism` (Include SIMPRIM Modules in Verilog File)

This option includes SIMPRIM modules from the SIMPRIM library in the output Verilog (`.v`) file. This option lets you avoid specifying the library path during simulation, but increases the size of your netlist file and your compile time.

When you use this option, NetGen checks that your library path is set up properly. Following is an example of the appropriate path:

```
$XILINX/verilog/src/simprim
```

If you are using compiled libraries, this switch offers no advantage. If you use this switch, do not use the `-ul` switch.

Note The `-ism` option is valid for post-translate (NGD), post-map, and post-place and route simulation flows.

Syntax

```
-ism
```

`-ne` (No Name Escaping)

This option replaces invalid characters with underscores, so that name escaping does not occur. For example, the net name `"p1$40/empty"` becomes `"p1$40_empty"` when you do not use name escaping. The leading backslash does not appear as part of the identifier. The resulting Verilog file can be used if a vendor's Verilog software cannot interpret escaped identifiers correctly.

Syntax

-ne

By default (without the `-ne` option), NetGen “escapes” illegal block or net names in your design by placing a leading backslash (\) before the name and appending a space at the end of the name. For example, the net name “p1\$40/empty” becomes “\p1\$40/empty ” when name escaping is used. Illegal Verilog characters are reserved Verilog names, such as “input” and “output,” and any characters that do not conform to Verilog naming standards.

-pf (Generate PIN File)

This option tells NetGen to generate a PIN file.

This option is available for FPGA/Cadence only.

Syntax

-pf

-sdf_anno (Include \$sdf_annotate)

This option controls the inclusion of the `$sdf_annotate` construct in a Verilog netlist. The default for this option is true. To disable this option, use false.

Note The `-sdf_anno` option is valid for the timing simulation flow.

Syntax

-sdf_anno [true|false]

-sdf_path (Full Path to SDF File)

This option outputs the SDF file to the specified full path. This option writes the full path and the SDF file name to the `$sdf_annotate` statement. If a full path is not specified, it writes the full path of the current work directory and the SDF file name to the `$sdf_annotate` statement.

Note The `-sdf_path` option is valid for the timing simulation flow.

Syntax

-sdf_path [*path_name*]

-shm (Write \$shm Statements in Test Fixture File)

This option places `$shm` statements in the structural Verilog file created by NetGen. These `$shm` statements allow NC-Verilog to display simulation data as waveforms. This option is for use with Cadence NC-Verilog files only.

Syntax

-shm

-ul (Write uselib Directive)

This option causes NetGen to write a library path pointing to the SimPrim library into the output Verilog (.v) file. The path is written as shown below:

```
uselib dir=$XILINX/verilog/src/simprims libext=.v
```

`$XILINX` is the location of the Xilinx software.

If you do not enter a `-u1` option, the `'uselib` line is not written into the Verilog file.

Note A blank `'uselib` statement is automatically appended to the end of the Verilog file to clear out the `'uselib` data. If you use this option, do not use the `-ism` option.

Note The `-u1` option is valid for SIMPRIM-based functional simulation and timing simulation flows; although not all simulators support the `'uselib` directive. Xilinx recommends using this option with caution.

Syntax

`-u1`

-vcd (Write \$dump Statements In Test Fixture File)

This option writes `$dumpfile/$dumpvars` statements in testfixture. This option is for use with Cadence Verilog files only.

Syntax

`-vcd`

VHDL-Specific Options for Functional and Timing Simulation

This section describes the VHDL-specific command line options for timing simulation.

- [-a \(Architecture Only\)](#)
- [-ar \(Rename Architecture Name\)](#)
- [-extid \(Extended Identifiers\)](#)
- [-rpw \(Specify the Pulse Width for ROC\)](#)
- [-tpw \(Specify the Pulse Width for TOC\)](#)

-a (Architecture Only)

This option suppresses generation of entities in the output. When specified, only architectures appear in the output. By default, NetGen generates both entities and architectures for the input design.

Syntax

`-a`

-ar (Rename Architecture Name)

This option lets you change the architecture name generated by NetGen. The default architecture name for each entity in the netlist is STRUCTURE.

Syntax

`-ar architecture_name`

-extid (Extended Identifiers)

This option instructs NetGen to write VHDL extended identifiers. There are two types of identifiers: basic and extended. By default, NetGen writes basic identifiers only.

Syntax

`-extid`

-rpw (Specify the Pulse Width for ROC)

This option specifies the pulse width, in nanoseconds, for the ROC component. You must specify a positive integer to simulate the component. This option is not required. By default, the ROC pulse width is set to 100 ns.

Syntax

```
-rpw roc_pulse_width
```

-tpw (Specify the Pulse Width for TOC)

This option specifies the pulse width, in nanoseconds, for the TOC component. You must specify a positive integer to simulate the component. This option is required when you instantiate the TOC component (for example, when the global set/reset and global 3-State nets are sourceless in the design).

Syntax

```
-tpw toc_pulse_width
```

NetGen Equivalence Checking Flow

This section describes the NetGen Equivalence Checking flow, which is used for formal verification of FPGA designs. This flow creates a Verilog netlist and conformal or formality assertion file for use with supported equivalence checking tools.

Post-NGDBuild Flow for FPGAs

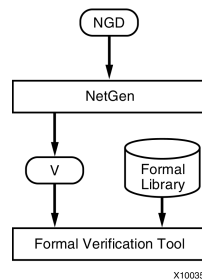

Post-Implementation Flow for FPGAs

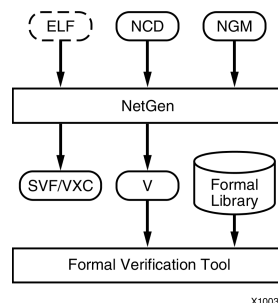

Input files for NetGen Equivalence Checking

The NetGen Equivalence Checking flow uses the following files as input:

- **NGD file** - This file is a logical description of an unmapped FPGA design.
- **NCD file** - This physical design file may be mapped only, partially or fully placed, or partially or fully routed.
- **NGM file** - This mapped design file is generated by MAP and contains information on what was trimmed and transformed during the MAP process. See [-ngm \(Design Correlation File\)](#) for more information.
- **ELF (MEM) (optional)** - This file is used to populate the Block RAMs specified in the .bmm file. See [-bd \(Block RAM Data File\)](#) for more information.

Output files for NetGen Equivalence Checking

The NetGen Equivalence Checking flow uses the following files as output:

- **Verilog (.v) file** - An IEEE 1364-2001 compliant Verilog HDL file that contains the netlist information obtained from the input file. This file is an equivalence checking model and cannot be synthesized or used in any other manner than equivalence checking.
- **Formality (.svf) file** - An assertion file written for the Formality equivalence checking tool. This file provides information about some of the transformations that a design went through, after it was processed by Xilinx implementation tools.
- **Conformal-LEC (.vxc) file** - An assertion file written for the Conformal-LEC equivalence checking tool. This file provides information about some of the transformations that a design went through, after it was processed by Xilinx implementation tools.

Note For specific information on Conformal-LEC and Formality tools, please refer to the [Synthesis and Simulation Design Guide \(UG626\)](#).

Syntax for NetGen Equivalence Checking

The following command runs the NetGen Equivalence Checking flow:

```
netgen -ecn [tool_name] [options] input_file[.ncd|.ngd] ngm_file
```

options is one or more of the options listed in the [Options for NetGen Equivalence Checking Flow](#) section.

tool_name is a required switch that generates a netlist compatible with equivalence checking tools. Valid *tool_name* arguments are **conformal** or **formality**. For additional information on equivalence checking and formal verification tools, please refer to the Synthesis and Simulation Design Guide.

input_file is the input file name. If an NGD file is used, the .ngd extension must be specified.

ngm_file (optional, but recommended) is the input file name, which is a design file, produced by MAP, that contains information about what was trimmed and transformed during the MAP process.

To get help on the command line for NetGen Equivalence Checking commands, type **netgen -h ecn**.

Options for NetGen Equivalence Checking Flow

This section describes the supported NetGen command line options for equivalence checking.

- [-aka \(Write Also-Known-As Names as Comments\)](#)
- [-bd \(Block RAM Data File\)](#)
- [-bx \(Block RAM Init File Directory\)](#)
- [-dir \(Directory Name\)](#)
- [-ecn \(Equivalence Checking\)](#)
- [-fn \(Control Flattening a Netlist\)](#)
- [-intstyle \(Integration Style\)](#)
- [-mhf \(Multiple Hierarchical Files\)](#)
- [-ne \(No Name Escaping\)](#)
- [-ngm \(Design Correlation File\)](#)
- [-w \(Overwrite Existing Files\)](#)

-aka (Write Also-Known-As Names as Comments)

This option includes original user-defined identifiers as comments in the netlist. This option is useful if user-defined identifiers are changed because of name legalization processes in NetGen.

Syntax

-aka

-bd (Block RAM Data File)

This option specifies the path and file name of the file used to populate the Block RAM instances specified in the `.bmm` file. Data2MEM can determine the **ADDRESS_BLOCK** in which to place the data from address and data information in the `.elf` (from EDK) or `.mem` file. You can include more than one instance of **-bd**.

Optionally, you can specify **tag tagname**, in which case only the address spaces with the same name in the `.bmm` file are used for translation, and data outside of the *tagname* address spaces are ignored.

Syntax

-bd *filename* [`.elf` | `.mem`] [**tag** *tagname*]

Note When using this option, you must also use [-bx \(Block RAM Init Files Directory\)](#) to specify the directory into which the Block RAM Initialization files will be written.

-bx (Block RAM Init Files Directory)

This option specifies the directory into which the Block RAM Initialization files will be written.

Syntax

-bx *bram_output_dir*

-dir (Directory Name)

This option specifies the directory for the output files.

Syntax

```
-dir directory_name
```

-ecn (Equivalence Checking)

This option generates an equivalence checking netlist to use in formal verification of an FPGA design.

For additional information on equivalence checking and formal verification tools, please refer to the [Synthesis and Simulation Design Guide \(UG626\)](#).

Syntax

```
netgen -ecn tool_name
```

tool_name is the name of the tool for which to output the netlist. Valid tool names are conformal and formality.

-fn (Control Flattening a Netlist)

This option outputs a flattened netlist. A flat netlist does not include any design hierarchy.

Syntax

```
-fn
```

-intstyle (Integration Style)

This option limits screen output, based on the integration style that you are running, to warning and error messages only.

Syntax

```
-intstyle ise|xflow
```

When using **-intstyle**, one of three modes must be specified:

- **-intstyle ise** indicates the program is being run as part of an integrated design environment.
- **-intstyle xflow** indicates the program is being run as part of an integrated batch flow.

Note **-intstyle** is automatically invoked when running in an integrated environment such as Project Navigator or XFLOW.

-mhf (Multiple Hierarchical Files)

This option is used to write multiple hierarchical files. One hierarchical file will be written for each module that has the KEEP_HIERARCHY attribute.

Note See [Preserving and Writing Hierarchy Files](#) for additional information.

Syntax

```
-mhf
```

-ne (No Name Escaping)

This option replaces invalid characters with underscores, so that name escaping does not occur. For example, the net name "p1\$40/empty" becomes "p1\$40_empty" when you do not use name escaping. The leading backslash does not appear as part of the identifier. The resulting Verilog file can be used if a vendor's Verilog software cannot interpret escaped identifiers correctly.

Syntax

-ne

By default (without the -ne option), NetGen "escapes" illegal block or net names in your design by placing a leading backslash (\) before the name and appending a space at the end of the name. For example, the net name "p1\$40/empty" becomes "\p1\$40/empty" when name escaping is used. Illegal Verilog characters are reserved Verilog names, such as "input" and "output," and any characters that do not conform to Verilog naming standards.

-ngm (Design Correlation File)

This option is used to specify an NGM design correlation file. This option is used for equivalence checking flows.

Syntax

-ngm [*ngm_file*]

-w (Overwrite Existing Files)

This option causes NetGen to overwrite the netlist (.vhd or .v) file if it exists. By default, NetGen does not overwrite the netlist file.

Note All other output files are automatically overwritten.

Syntax

-w

NetGen Static Timing Analysis Flow

This section describes the NetGen Static Timing Analysis flow, which is used for analyzing the timing, including minimum of maximum delay values, of FPGA designs.

Minimum of maximum delays are used by static timing analysis tools to calculate skew, setup and hold values. Minimum of maximum delays are the minimum delay values of a device under a specified operating condition (speed grade, temperature and voltage). If the operating temperature and voltage are not specified, then the worst case temperature and voltage values are used. Note that the minimum of maximum delay value is different from the process minimum generated by using the **-s min** option.

The following example shows DELAY properties containing relative minimum and maximum delays.

```
(DELAY)
(ABSOLUTE)
(PORT I (234:292:292) (234:292:292))
(IOPATH I O (392:489:489) (392:489:489))
```

Note Both the TYP and MAX fields contain the maximum delay.

NetGen uses the Static Timing Analysis flow to generate Verilog and SDF netlists compatible with supported static timing analysis tools.

Static Timing Analysis Flow for FPGAs

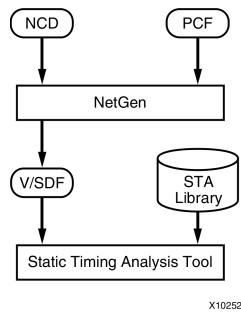

Input files for Static Timing Analysis

The Static Timing Analysis flow uses the following files as input:

- **NCD file** - This physical design file may be mapped only, partially or fully placed, or partially or fully routed.
- **PCF (optional)** - This is a physical constraints file. If prorated voltage and temperature is applied to the design, the PCF file must be included to pass this information to NetGen. See [-pcf \(PCF File\)](#) for more information.

Output files for Static Timing Analysis

The Static Timing Analysis flow uses the following files as output:

- **SDF file** - This SDF 3.0 compliant standard delay format file contains delays obtained from the input file.
- **Verilog (.v) file** - An IEEE 1364-2001 compliant Verilog HDL file that contains netlist information obtained from the input file. This file is a timing simulation model and cannot be synthesized or used in any manner other than for static timing analysis. This netlist uses simulation primitives, which may not represent the true implementation of the device. The netlist represents a functional model of the implemented design.

Syntax for NetGen Static Timing Analysis

The following command runs the NetGen Static Timing Analysis flow:

```
netgen -sta input_file [.ncd]
```

input_file is the input file name.

To get help on the command line for static timing analysis, type **netgen -h sta**.

Options for NetGen Static Timing Analysis Flow

This section describes the supported NetGen command line options for static timing analysis.

- [-aka \(Write Also-Known-As Names as Comments\)](#)
- [-bd \(Block RAM Data File\)](#)
- [-bx \(Block RAM Init File Directory\)](#)
- [-dir \(Directory Name\)](#)
- [-fn \(Control Flattening a Netlist\)](#)
- [-intstyle \(Integration Style\)](#)
- [-mhf \(Multiple Hierarchical Files\)](#)
- [-ne \(No Name Escaping\)](#)
- [-pcf \(PCF File\)](#)
- [-s \(Change Speed\)](#)
- [-sta \(Generate Static Timing Analysis Netlist\)](#)
- [-w \(Overwrite Existing Files\)](#)

-aka (Write Also-Known-As Names as Comments)

This option includes original user-defined identifiers as comments in the netlist. This option is useful if user-defined identifiers are changed because of name legalization processes in NetGen.

Syntax

`-aka`

-bd (Block RAM Data File)

This option specifies the path and file name of the file used to populate the Block RAM instances specified in the `.bmm` file. Data2MEM can determine the **ADDRESS_BLOCK** in which to place the data from address and data information in the `.elf` (from EDK) or `.mem` file. You can include more than one instance of `-bd`.

Optionally, you can specify `tag tagname`, in which case only the address spaces with the same name in the `.bmm` file are used for translation, and data outside of the `tagname` address spaces are ignored.

Syntax

`-bd filename [.elf|.mem] [tag tagname]`

Note When using this option, you must also use [-bx \(Block RAM Init Files Directory\)](#) to specify the directory into which the Block RAM Initialization files will be written.

-bx (Block RAM Init Files Directory)

This option specifies the directory into which the Block RAM Initialization files will be written.

Syntax

`-bx bram_output_dir`

-dir (Directory Name)

This option specifies the directory for the output files.

Syntax

`-dir directory_name`

-fn (Control Flattening a Netlist)

This option outputs a flattened netlist. A flat netlist does not include any design hierarchy.

Syntax

`-fn`

-intstyle (Integration Style)

This option limits screen output, based on the integration style that you are running, to warning and error messages only.

Syntax

`-intstyle ise|xflow`

When using `-intstyle`, one of three modes must be specified:

- `-intstyle ise` indicates the program is being run as part of an integrated design environment.
- `-intstyle xflow` indicates the program is being run as part of an integrated batch flow.

Note `-intstyle` is automatically invoked when running in an integrated environment such as Project Navigator or XFLOW.

-mhf (Multiple Hierarchical Files)

This option is used to write multiple hierarchical files. One hierarchical file will be written for each module that has the KEEP_HIERARCHY attribute.

Note See [Preserving and Writing Hierarchy Files](#) for additional information.

Syntax

`-mhf`

-ne (No Name Escaping)

This option replaces invalid characters with underscores, so that name escaping does not occur. For example, the net name "p1\$40/empty" becomes "p1\$40_empty" when you do not use name escaping. The leading backslash does not appear as part of the identifier. The resulting Verilog file can be used if a vendor's Verilog software cannot interpret escaped identifiers correctly.

Syntax

`-ne`

By default (without the `-ne` option), NetGen "escapes" illegal block or net names in your design by placing a leading backslash (\) before the name and appending a space at the end of the name. For example, the net name "p1\$40/empty" becomes "\ p1\$40/empty" when name escaping is used. Illegal Verilog characters are reserved Verilog names, such as "input" and "output," and any characters that do not conform to Verilog naming standards.

-pcf (PCF File)

This option lets you specify a Physical Constraints File (PCF) as input to NetGen. You only need to specify a PCF file if you use prorating constraints (temperature and/or voltage).

Temperature and voltage constraints and prorated delays are described in the [Constraints Guide \(UG625\)](#).

Syntax

```
-pcf pcf_file .pcf
```

-s (Change Speed)

This option instructs NetGen to annotate the device speed grade you specify to the netlist.

Syntax

```
-s speed grade |min
```

speed grade can be entered with or without the leading dash. For example, both **-s 3** and **-s -3** are allowed.

Some architectures support the **-s min** option, which instructs NetGen to annotate a process minimum delay, rather than a maximum worst-case to the netlist. Use the Speedprint or PARTGen utility programs in the software to determine whether process minimum delays are available for your target architecture. See the [PARTGen chapter](#) for additional information.

Settings made with this option override prorated timing parameters in the Physical Constraints File (PCF). If you use **-s min**, all fields in the resulting SDF file (MIN:TYP:MAX) are set to the process minimum value.

-sta (Generate Static Timing Analysis Netlist)

This option writes a static timing analysis netlist.

Syntax

```
-sta
```

-w (Overwrite Existing Files)

This option causes NetGen to overwrite the netlist (.vhd or .v) file if it exists. By default, NetGen does not overwrite the netlist file.

Note All other output files are automatically overwritten.

Syntax

```
-w
```

Preserving and Writing Hierarchy Files

When hierarchy is preserved during synthesis and implementation using the KEEP_HIERARCHY constraint, the NetGen -mhf option writes separate netlists and SDF files (if applicable) for each piece of hierarchy.

The hierarchy of STARTUP and glbl (Verilog only) modules is preserved in the output netlist. If the -mhf option is used and there is at least one hierarchical block with the KEEP_HIERARCHY constraint in the design, NetGen writes out a separate netlist file for the STARTUP and glbl modules. If there is no block with the KEEP_HIERARCHY constraint, the -mhf option is ignored even if there are STARTUP and glbl modules in the design.

This section describes the output file types produced with the -mhf option. The type of netlist output by NetGen depends on whether you are running the NetGen simulation, equivalence checking, or static timing analysis flow. For simulation, NetGen outputs a Verilog or VHDL file. The -ofmt option must be used to specify the output file type you wish to produce when you are running the NetGen simulation flow.

Note When Verilog is specified, the \$sdf_annotate is included in the Verilog netlist for each module.

The following table lists the base naming convention for hierarchy output files:

Hierarchy File Content

Hierarchy File Content	Simulation	Equivalence Checking	Static Timing Analysis
File with Top-level Module	[input_filename] (default), or user specified output filename	[input_filename].ecn, or user specified output filename	[input_filename].sta, or user specified output filename
File with Lower Level Module	[module_name].sim	[module_name].ecn	[module_name].sta

The [module_name] is the name of the hierarchical module from the front-end that the user is already familiar with. There are cases when the [module_name] could differ, they are:

- If multiple instances of a module are used in the design, then each instantiation of the module is unique because the timing for the module is different. The names are made unique by appending an underscore followed by a INST_ string and a count value (e.g., numgen, numgen_INST_1, numgen_INST_2).
- If a new filename clashes with an existing filename within the name scope, then the new name will be [module_name]_[instance_name].

Testbench File

A testbench file is created for the top-level design when the -tb option is used. The base name of the testbench file is the same as the base name of the design, with a .tv extension for Verilog, and a .tvhd extension for VHDL.

Hierarchy Information File

In addition to writing separate netlists, NetGen also generates a separate text file containing hierarchy information. The following information appears in the hierarchy text file. NONE appears if one of the files does not have relative information.

```
// Module : The name of the hierarchical design module.
// Instance : The instance name used in the parent module.
// Design File : The name of the file that contains the module.
// SDF File : The SDF file associated with the module.
// SubModule : The sub module(s) contained within a given module.
// Module, Instance : The sub module and instance names.
```

Note The hierarchy information file for a top-level design does not contain an Instance field.

The base name of the hierarchy information file is: *design_base_name_mhf_info.txt*

The STARTUP block is only supported on the top-level design module. The global set reset (GSR) and global tristate signal (GTS) connectivity of the design is maintained as described in the [Dedicated Global Signals in Back-Annotation Simulation](#) section of this chapter.

Dedicated Global Signals in Back-Annotation Simulation

The global set reset (GSR), PRLD for CPLDs, signal and global tristate signal (GTS) are global routing nets present in the design that provide a means of setting, resetting, or tristating applicable components in the device. The simulation behavior of these signals is modeled in the library cells of the Xilinx SIMPRIM library and the simulation netlist using the `glbl` module in Verilog and the `X_ROC / X_TOC` components in VHDL.

The following sections explain the connectivity for Verilog and VHDL netlists.

Global Signals in Verilog Netlist

For Verilog, the `glbl` module is used to model the default behavior of GSR and GTS. The `glbl.GSR` and `glbl.GTS` can be directly referenced as global GSR/GTS signals anywhere in a design or in any library cells.

NetGen writes out the `glbl` module definition in the output Verilog netlist. For a non-hierarchical design or a single-file hierarchical design, this `glbl` module definition is written at the bottom of the netlist. For a single-file hierarchical design, the `glbl` module is defined inside the top-most module. For a multi-file hierarchical design (`-mhf` option), NetGen writes out `glbl.v` as a hierarchical module.

If the GSR and GTS are brought out to the top-level design as ports using the `-gp` and `-tp` options, the top-most module has the following connectivity:

```
glbl.GSR = GSR_PORT
glbl.GTS = GTS_PORT
```

The `GSR_PORT` and `GTS_PORT` are ports on the top-level module created with the `-gp` and `-tp` options. If you use a STARTUP block in the design, the STARTUP block is translated to buffers that preserve the intended connectivity of the user-controlled signals to the global GSR and GTS (`glbl.GSR` and `glbl.GTS`).

When there is a STARTUP block in the design, the STARTUP block hierarchical level is always preserved in the output netlist. The output of STARTUP is connected to the global GSR/GTS signals (`glbl.GSR` and `glbl.GTS`).

For all hierarchical designs, the `glbl` module must be compiled and referenced along with the design. For information on setting the GSR and GTS for FPGAs, see the [Synthesis and Simulation Design Guide \(UG626\)](#).

Global Signals in VHDL Netlist

Global signals for VHDL netlists are GSR and GTS, which are declared in the library package `Simprim_Vcomponents.vhd`. The GSR and GTS can be directly referenced anywhere in a design or in any library cells.

The `X_ROC` and `X_TOC` components in the VHDL library model the default behavior of the GSR and GTS. If the `-gp` and `-tp` options are not used, NetGen instantiates `X_ROC` and `X_TOC` in the output netlist. Each design has only one instance of `X_ROC` and `X_TOC`. For hierarchical designs, `X_ROC` and `X_TOC` are instantiated in the top-most module netlist.

X_ROC and X_TOC are instantiated as shown below:

```
X_ROC (O => GSR) ;  
X_TOC (O => GTS) ;
```

If the GSR and GTS are brought out to the top-level design using the `-gp` and `-tp` options, there will be no X_ROC or X_TOC instantiation in the design netlist. Instead, the top-most module has the following connectivity:

```
GSR<= GSR_PORT  
GTS<= GTS_PORT
```

The GSR_PORT and GTS_PORT are ports on the top-level module created with the `-gp` and `-tp` options.

When there is a STARTUP block in the design, the STARTUP block hierarchical level is preserved in the output netlist. The output of STARTUP is connected to the global GSR and GTS signals.

For information on setting GSR and GTS for FPGAs, see the [Synthesis and Simulation Design Guide \(UG626\)](#).

Logical Design Rule Check (DRC)

This chapter describes the Logical Design Rule Check (DRC).

Logical DRC Overview

The Logical Design Rule Check (DRC), also known as the NGD DRC, comprises a series of tests to verify the logical design in the Native Generic Database (NGD) file. The Logical DRC performs device-independent checks.

The Logical DRC generates messages to show the status of the tests performed. Messages can be error messages (for conditions where the logic will not operate correctly) or warnings (for conditions where the logic is incomplete).

The Logical DRC runs automatically at the following times:

- At the end of NGDBuild, before NGDBuild writes out the NGD file
NGDBuild writes out the NGD file if DRC warnings are discovered, but does not write out an NGD file if DRC errors are discovered.
- At the end of NetGen, before writing out the netlist file
The netlist writer (NetGen) does not perform the entire DRC. It only performs the Net checks and Name checks. The netlist writer writes out a netlist file even if DRC warnings or errors are discovered.

Logical DRC Device Support

This program is compatible with the following device families:

- 7 series
- Spartan®-3, Spartan-3A, Spartan-3E, and Spartan-6
- Virtex®-4, Virtex-5, and Virtex-6
- CoolRunner™ XPLA3 and CoolRunner-II
- XC9500 and XC9500XL

Logical DRC Checks

The Logical DRC performs the following types of checks:

- [Block check](#)
- [Net check](#)
- [Pad check](#)
- [Clock buffer check](#)
- [Name check](#)
- [Primitive pin check](#)

Block Check

The block check verifies that each terminal symbol in the NGD hierarchy (that is, each symbol that is not resolved to any lower-level components) is an NGD primitive. A block check failure is treated as an error. As part of the block check, the DRC also checks user-defined properties on symbols and the values on the properties to make sure they are legal.

Net Check

The net check determines the number of NGD primitive output pins (drivers), 3-state pins (drivers), and input pins (loads) on each signal in the design. If a signal does not have at least one driver (or one 3-state driver) and at least one load, a warning is generated. An error is generated if a signal has multiple non-3-state drivers or any combination of 3-state and non-3-state drivers. As part of the net check, the DRC also checks user-defined properties on signals and the values on the properties to make sure they are legal.

Pad Check

The pad check verifies that each signal connected to pad primitives obeys the following rules.

- If the PAD is an input pad, the signal to which it is connected can only be connected to the following types of primitives:
 - Buffers
 - Clock buffers
 - PULLUP
 - PULLDOWN
 - KEEPER
 - BSCAN

The input signal can be attached to multiple primitives, but only one of each of the above types. For example, the signal can be connected to a buffer primitive, a clock buffer primitive, and a PULLUP primitive, but it cannot be connected to a buffer primitive and two clock buffer primitives. Also, the signal cannot be connected to both a PULLUP primitive and a PULLDOWN primitive. Any violation of the rules above results in an error, with the exception of signals attached to multiple pull-ups or pull-downs, which produces a warning. A signal that is not attached to any of the above types of primitives also produces a warning.

- If the PAD is an output pad, the signal it is attached to can only be connected to one of the following primitive outputs:

- A single buffer primitive output
- A single 3-state primitive output
- A single BSCAN primitive

In addition, the signal can also be connected to one of the following primitives:

- A single PULLUP primitive
- A single PULLDOWN primitive
- A single KEEPER primitive

Any other primitive output connections on the signal will result in an error.

If the condition above is met, the output PAD signal may also be connected to one clock buffer primitive input, one buffer primitive input, or both.

- If the PAD is a bidirectional or unbonded pad, the signal it is attached to must obey the rules stated above for input and output pads. Any other primitive connections on the signal results in an error. The signal connected to the pad must be configured as both an input and an output signal; if it is not, you receive a warning.
- If the signal attached to the pad has a connection to a top-level symbol of the design, that top-level symbol pin must have the same type as the pad pin, except that output pads can be associated with 3-state top-level pins. A violation of this rule results in a warning.
- If a signal is connected to multiple pads, an error is generated. If a signal is connected to multiple top-level pins, a warning is generated.

Clock Buffer Check

The clock buffer configuration check verifies that the output of each clock buffer primitive is connected to only inverter, flip-flop or latch primitive clock inputs, or other clock buffer inputs. Violations are treated as warnings.

Name Check

The name check verifies the uniqueness of names on NGD objects using the following criteria:

- Pin names must be unique within a symbol. A violation results in an error.
- Instance names must be unique within the instances position in the hierarchy (that is, a symbol cannot have two symbols with the same name under it). A violation results in a warning.
- Signal names must be unique within the signals hierarchical level (that is, if you push down into a symbol, you cannot have two signals with the same name). A violation results in a warning.
- Global signal names must be unique within the design. A violation results in a warning.

Primitive Pin Check

The primitive pin check verifies that certain pins on certain primitives are connected to signals in the design.

NGDBuild

This chapter describes the NGDBuild program.

NGDBuild Overview

NGDBuild reads in a netlist file in EDIF or NGC format and creates a Xilinx® Native Generic Database (NGD) file that contains a logical description of the design in terms of logic elements, such as AND gates, OR gates, LUTs, flip-flops, and RAMs.

The NGD file contains both a logical description of the design reduced to Xilinx primitives and a description of the original hierarchy expressed in the input netlist. The output NGD file can be mapped to the desired device family.

The following figure shows a simplified version of the NGDBuild design flow. NGDBuild invokes other programs that are not shown in the following figure.

NGDBuild Design Flow

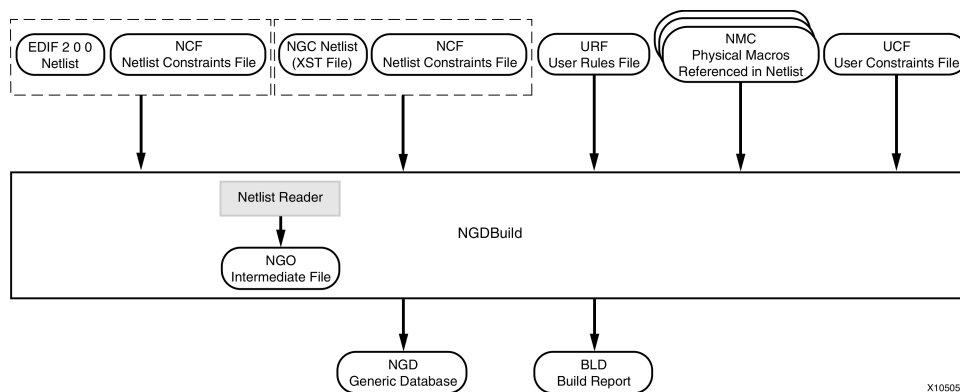

X10505

NGDBuild Device Support

This program is compatible with the following device families:

- 7 series
- Spartan®-3, Spartan-3A, Spartan-3E, and Spartan-6
- Virtex®-4, Virtex-5, and Virtex-6
- CoolRunner™ XPLA3 and CoolRunner-II
- XC9500 and XC9500XL

Converting a Netlist to an NGD File

NGDBuild performs the following steps to convert a netlist to an NGD file:

1. Reads the source netlist
 NGDBuild invokes the Netlist Launcher. The Netlist Launcher determines the input netlist type and starts the appropriate netlist reader program. The netlist reader incorporates NCF files associated with each netlist. NCF files contain timing and layout constraints for each module. The Netlist Launcher is described in detail in the [Netlist Launcher \(Netlister\)](#) appendix.
2. Reduces all components in the design to NGD primitives
 NGDBuild merges components that reference other files. NGDBuild also finds the appropriate system library components, physical macros (NMC files), and behavioral models.
3. Checks the design by running a Logical Design Rule Check (DRC) on the converted design
 Logical DRC is a series of tests on a logical design. It is described in [the Logical Design Rule Check chapter](#).
4. Writes an NGD file as output

Note This procedure, the Netlist Launcher, and the netlist reader programs are described in more detail in the [Appendix](#).

NGDBuild Input Files

NGDBuild uses the following files as input:

The input design can be an EDIF 2 0 0 or NGC netlist file. If the input netlist is in another format recognized by the Netlist Launcher, the Netlist Launcher invokes the program necessary to convert the netlist to EDIF format and then invokes the appropriate netlist reader, EDIF2NGD.

With the default Netlist Launcher options, NGDBuild recognizes and processes files with the extensions shown in the following table. NGDBuild searches the top-level design netlist directory for a netlist file with one of the extensions. By default, NGDBuild searches for an EDIF file first.

File Type	Recognized Extensions
EDIF	.sedif, .edn, .edf, .edif
NGC	.ngc

Remove all out of date netlist files from your directory. Obsolete netlist files may cause errors in NGDBuild.

- **UCF file** - The User Constraints File (UCF) is an ASCII file that you create. You can create this file by hand or by using the Constraints Editor. See the Help provided with the Constraints Editor for more information. The UCF file contains timing and layout constraints that affect how the logical design is implemented in the target device. The constraints in the file are added to the information in the output NGD file. For more information on constraints, see the [Constraints Guide \(UG625\)](#).

By default, NGDBuild reads the constraints in the UCF file automatically if the UCF file has the same base name as the input design file and a .ucf extension. You can override the default behavior and specify a different constraints file with the `-uc` option. See [-uc \(User Constraints File\)](#) for more information.

- **NCF** - The Netlist Constraints File (NCF) is produced by a CAE vendor toolset. This file contains constraints specified within the toolset. The netlist reader invoked by NGDBuild reads the constraints in this file if the NCF has the same name as the input EDIF or NGC netlist. It adds the constraints to the intermediate NGO file and

the output Native Generic Database (NGD) file. NCF files are read in and annotated to the NGO file during an `edif2ngd` conversion. This also implies that unlike UCF files, NCF constraints only bind to a single netlist; they do not cross file hierarchies.

Note NGDBuild checks to make sure the NGO file is up-to-date and reruns EDIF2NGD only when the EDIF has a timestamp that is newer than the NGO file. Updating the NCF has no affect on whether EDIF2NGD is rerun. Therefore, if the NGO is up-to-date and you only update the NCF file (not the EDIF), use the `-nt on` option to force the regeneration of the NGO file from the unchanged EDIF and new NCF. See [-nt \(Netlist Translation Type\)](#) for more information.

- **URF file** - The User Rules File (URF) is an ASCII file that you create. The Netlist Launcher reads this file to determine the acceptable netlist input files, the netlist readers that read these files, and the default netlist reader options. This file also allows you to specify third-party tool commands for processing designs. The URF can add to or override the rules in the system rules file.

You can specify the location of the URF with the NGDBuild `-ur` option. The URF must have a `.urf` extension. See [-ur \(Read User Rules File\)](#) or [User Rules File \(URF\)](#) in Appendix B for more information.

- **NGC file** - This binary file can be used as a top-level design file or as a module file: Top-level design file.

This file is output by the Xilinx Synthesis Technology (XST) software. See the description of design files earlier in this section for details.

Note This is not a true netlist file. However, it is referred to as a netlist in this context to differentiate it from the NGC module file. NGC files are equivalent to NGO files created by EDIF2NGD, but are created by XST and CORE Generator™ software.

- **NMC files** - These physical macros are binary files that contain the implementation of a physical macro instantiated in the design. NGDBuild reads the NMC file to create a functional simulation model for the macro.

Unless a full path is provided to NGDBuild, it searches for netlist, NCF, NGC, NMC, and MEM files in the following locations:

- The working directory from which NGDBuild was invoked.
- The path specified for the top-level design netlist on the NGDBuild command line.
- Any path specified with the `-sd` ([Search Specified Directory](#)) on the NGDBuild command line.

NGDBuild Intermediate Files

NGO files - These binary files contain a logical description of the design in terms of its original components and hierarchy. These files are created when NGDBuild reads the input EDIF netlist. If these files already exist, NGDBuild reads the existing files. If these files do not exist or are out of date, NGDBuild creates them.

NGDBuild Output Files

NGDBuild creates the following files as output:

- **NGD file** - The Native Generic Database (NGD) file is a binary file containing a logical description of the design in terms of both its original components and hierarchy and the primitives to which the design is reduced.
- **BLD file** - This build report file contains information about the NGDBuild run and about the subprocesses run by NGDBuild. Subprocesses include EDIF2NGD, and programs specified in the URF. The BLD file has the same root name as the output NGD file and a `.blb` extension. The file is written into the same directory as the output NGD file.

NGDBuild Syntax

```
ngdbuild [options] design_name [ngd_file [.ngd]]
```

options can be any number of the NGDBuild command line options listed in [NGDBuild Options](#). Enter options in any order, preceded them with a dash (minus sign on the keyboard) and separate them with spaces.

design_name is the top-level name of the design file you want to process. To ensure the design processes correctly, specify a file extension for the input file, using one of the legal file extensions specified in [Overview section](#). Using an incorrect or nonexistent file extension causes NGDBuild to fail without creating an NGD file. If you use an incorrect file extension, NGDBuild may issue an unexpanded error.

Note If you are using an NGC file as your input design, you should specify the `.ngc` extension. If NGDBuild finds an EDIF netlist or NGO file in the project directory, it does not check for an NGC file.

ngd_file is the output file in NGD format. The output file name, its extension, and its location are determined as follows:

- If you do not specify an output file name, the output file has the same name as the input file, with an `.ngd` extension.
- If you specify an output file name with no extension, NGDBuild appends the `.ngd` extension to the file name.
- If you specify a file name with an extension other than `.ngd`, you get an error message and NGDBuild does not run.
- If the output file already exists, it is overwritten with the new file.

NGDBuild Options

This section describes the NGDBuild command line options.

- `-a` (Add PADs to Top-Level Port Signals)
- `-aul` (Allow Unmatched LOCs)
- `-aut` (Allow Unmatched Timegroups)
- `-bm` (Specify BMM Files)
- `-dd` (Destination Directory)
- `-f` (Execute Commands File)
- `-i` (Ignore UCF File)
- `-insert_keep_hierarchy` (Insert KEEP_HIERARCHY constraint)
- `-intstyle` (Integration Style)
- `-filter` (Filter File)
- `-l` (Libraries to Search)
- `-nt` (Netlist Translation Type)
- `-p` (Part Number)
- `-quiet` (Quiet)
- `-r` (Ignore LOC Constraints)
- `-sd` (Search Specified Directory)
- `-u` (Allow Unexpanded Blocks)
- `-uc` (User Constraints File)
- `-ur` (Read User Rules File)
- `-verbose` (Report All Messages)

-a (Add PADs to Top-Level Port Signals)

If the top-level input netlist is in EDIF format, this option causes NGDBuild to add a PAD symbol to every signal that is connected to a port on the root-level cell. This option has no effect on lower-level netlists.

Syntax

-a

Using the **-a** option depends on the behavior of your third-party EDIF writer. If your EDIF writer treats pads as instances (like other library components), do not use **-a**. If your EDIF writer treats pads as hierarchical ports, use **-a** to infer actual pad symbols. If you do not use **-a** where necessary, logic may be improperly removed during mapping. For EDIF files produced by Mentor Graphics and Cadence schematic tools, the **-a** option is set automatically; you do *not* have to enter **-a** explicitly for these vendors.

Note The NGDBuild **-a** option corresponds to the EDIF2NGD **-a** option. If you run EDIF2NGD on the top-level EDIF netlist separately, rather than allowing NGDBuild to run EDIF2NGD, you must use the two **-a** options consistently. If you previously ran NGDBuild on your design and NGO files are present, you must use the **-nt** option the first time you use **-a**. This forces a rebuild of the NGO files, allowing EDIF2NGD to run the **-a** option.

-aul (Allow Unmatched LOCs)

By default the program generates an error if the constraints specified for pin, net, or instance names in the UCF or NCF file cannot be found in the design, and an NGD file is not written. Use this option to generate a warning instead of an error for LOC constraints and make sure an NGD file is written.

Syntax

-aul

You may want to run this program with the **-aul** option if your constraints file includes location constraints for pin, net, or instance names that have not yet been defined in the HDL or schematic. This allows you to maintain one version of your constraints files for both partially complete and final designs.

Note When using this option, make sure you do not have misspelled net or instance names in your design. Misspelled names may cause inaccurate placing and routing.

-aut (Allow Unmatched Timegroups)

By default the program generates an error if timegroups specified in the UCF or NCF file cannot be found in the design, and an NGD file is not written. Use this option to generate a warning instead of an error for timegroup constraints and make sure an NGD file is written.

Syntax

-aut

You may want to run this program with the **-aut** option if your constraints file includes timegroup constraints that have not yet been defined in the HDL or schematic. This allows you to maintain one version of your constraints files for both partially complete and final designs.

Note When using this option, make sure you do not have misspelled timegroup names in your design. Misspelled names may cause inaccurate placing and routing.

-bm (Specify BMM Files)

This option specifies a switch for the BMM files. If the file extension is missing, a .bmm file extension is assumed.

Syntax

```
-bm file_name [.bmm]
```

If this option is unspecified, the ELF or MEM root file name with a .bmm extension is assumed. If only this option is given, then NGDBuild verifies that the BMM file is syntactically correct and makes sure that the instances specified in the BMM file exist in the design. Only one **-bm** option can be used.

-dd (Destination Directory)

This option specifies the directory for intermediate files (design NGO files and netlist files). If the **-dd** option is not specified, files are placed in the current directory.

Syntax

```
-dd NGOoutput_directory
```

-f (Execute Commands File)

This option executes the command line arguments in the specified *command_file*.

Syntax

```
-f command_file
```

For more information on the **-f** option, see [-f \(Execute Commands File\)](#) in the Introduction chapter.

-i (Ignore UCF File)

This option tells NGDBuild to ignore the UCF file. Without this option NGDBuild reads the constraints in the UCF file automatically if the UCF file in the top-level design netlist directory has the same base name as the input design file and a .ucf extension.

Syntax

```
-i
```

Note If you use this option, do not use the **-uc** option.

-insert_keep_hierarchy (Insert KEEP_HIERARCHY constraint)

This option automatically attaches the KEEP_HIERARCHY constraint to each input netlist. It should only be used when performing a bottom-up synthesis flow, where separate netlists are created for each piece of hierarchy. When using this option you should use good design practices as described in the [Synthesis and Simulation Design Guide \(UG626\)](#).

Syntax

```
-insert_keep_hierarchy
```

Note Care should be taken when trying to use this option with Cores, as they may not be coded for maintaining hierarchy.

-intstyle (Integration Style)

This option limits screen output, based on the integration style that you are running, to warning and error messages only.

Syntax

```
-intstyle ise|xflow
```

When using **-intstyle**, one of three modes must be specified:

- **-intstyle ise** indicates the program is being run as part of an integrated design environment.
- **-intstyle xflow** indicates the program is being run as part of an integrated batch flow.

Note **-intstyle** is automatically invoked when running in an integrated environment such as Project Navigator or XFLOW.

-filter (Filter File)

This option specifies a filter file, which contains settings to capture and filter messages produced by the program during execution.

Syntax

```
-filter [filter_file]
```

By default, the filter file name is `filter.filter`.

-l (Libraries to Search)

This option lets you list the libraries to search when determining what library components were used to build the design. This option is passed to the appropriate netlist reader. The information allows NGDBuild to determine the source of the design components so it can resolve the components to NGD primitives.

Syntax

```
-l {libname}
```

To specify multiple libraries, include multiple **-l libname** entries on the NGDBuild command line.

Valid entries for *libname* are:

- **xilinxun** (Xilinx® Unified library)
- **synopsys**

Note Using **-l xilinxun** is optional, since NGDBuild automatically accesses these libraries. In cases where NGDBuild automatically detects Synopsys designs (for example, the netlist extension is `.sedif`), **-l synopsys** is also optional.

-nt (Netlist Translation Type)

This option determines how timestamps are treated by the Netlist Launcher when it is invoked by NGDBuild. A timestamp is information in a file that indicates the date and time the file was created.

Syntax

```
-nt timestamp|on|off
```

timestamp (the default) instructs the Netlist Launcher to perform the normal timestamp check and update NGO files according to their timestamps.

on translates netlists regardless of timestamps (rebuilding all NGO files).

off does not rebuild an existing NGO file, regardless of its timestamp.

-p (Part Number)

This option specifies the part into which your design is implemented.

Syntax

`-p part_number`

Note For syntax details and examples, see [-p \(Part Number\)](#) in the Introduction chapter.

When you use this option, the NGD file produced by NGDBuild is optimized for mapping into that architecture.

You do not need to specify a part if your NGO file already contains information about the desired vendor and family (for example, if you placed a PART property in a schematic or a CONFIG PART statement in a UCF file). However, you can override the information in the NGO file with the `-p` option when you run NGDBuild.

-quiet (Quiet)

This option tells the program to only report error and warning messages.

Syntax

`-quiet`

-r (Ignore LOC Constraints)

This option eliminates all location constraints (LOC=) found in the input netlist or UCF file. Use this option when you migrate to a different device or architecture, because locations in one architecture may not match locations in another.

Syntax

`-r`

-sd (Search Specified Directory)

This option adds the specified *search_path* to the list of directories to search when resolving file references (that is, files specified in the schematic with a FILE=*filename* property) and when searching for netlist, NGO, NGC, NMC, and MEM files. You do not have to specify a search path for the top-level design netlist directory, because it is automatically searched by NGDBuild.

Syntax

`-sd {search_path}`

The *search_path* must be separated from the `-sd` option by spaces or tabs (for example, `-sd designs` is correct, `-sddesigns` is not). You can specify multiple search paths on the command line. Each must be preceded with the `-sd` option; you cannot specify more than one *search_path* with a single `-sd` option. For example, the following syntax is acceptable for specifying two search paths:

```
-sd /home/macros/counter -sd /home/designs/pal2
```

The following syntax is *not* acceptable:

```
-sd /home/macros/counter /home/designs/pal2
```

-u (Allow Unexpanded Blocks)

In the default behavior of NGDBuild (without the `-u` option), NGDBuild generates an error if a block in the design cannot be expanded to NGD primitives. If this error occurs, an NGD file is not written. If you enter this option, NGDBuild generates a warning instead of an error if a block cannot be expanded, and writes an NGD file containing the unexpanded block.

Syntax

```
-u
```

You may want to run NGDBuild with the `-u` option to perform preliminary mapping, placement and routing, timing analysis, or simulation on the design even though the design is not complete. To ensure the unexpanded blocks remain in the design when it is mapped, run the MAP program with the `-u` (Do Not Remove Unused Logic) option, as described in the [MAP](#) chapter.

-uc (User Constraints File)

This option specifies a User Constraints File (UCF) for the Netlist Launcher to read. UCF files contain timing and layout constraints that affect the way the logical design is implemented in the target device.

You can include multiple instances of the `-uc` option on the command line. Multiple UCF files are processed in the order they appear on the command line, and as though they are simply concatenated.

Note If you use this option, do not use the `-i` option.

Syntax

```
-uc ucf_file [ .ucf ]
```

ucf_file is the name of the UCF file. The user constraints file must have a `.ucf` extension. If you specify a user constraints file without an extension, NGDBuild appends the `.ucf` extension to the file name. If you specify a file name with an extension other than `.ucf`, you get an error message and NGDBuild does not run.

If you do not enter a `-uc` option and a UCF file exists with the same base name as the input design file and a `.ucf` extension, NGDBuild automatically reads the constraints in this UCF file.

For more information on constraints, see the [Constraints Guide \(UG625\)](#).

-ur (Read User Rules File)

This option specifies a user rules file for the Netlist Launcher to access. This file determines the acceptable netlist input files, the netlist readers that read these files, and the default netlist reader options. This file also allows you to specify third-party tool commands for processing designs.

Syntax

```
-ur rules_file [ .urf ]
```

The user rules file must have a `.urf` extension. If you specify a user rules file with no extension, NGDBuild appends the `.urf` extension to the file name. If you specify a file name with an extension other than `.urf`, you get an error message and NGDBuild does not run.

See [User Rules File \(URF\)](#) in Appendix B for more information.

-verbose (Report All Messages)

This option enhances screen output to include all messages output by the tools run: NGDBuild, the netlist launcher, and the netlist reader. This option is useful if you want to review details about the tools run.

Syntax

-verbose

MAP

This chapter describes the MAP program, which is used during the implementation process to map a logical design to a Xilinx® FPGA.

MAP Overview

The MAP program maps a logical design to a Xilinx® FPGA. The input to MAP is an NGD file, which is generated using the NGDBuild program. The NGD file contains a logical description of the design that includes both the hierarchical components used to develop the design and the lower level Xilinx primitives. The NGD file also contains any number of NMC (macro library) files, each of which contains the definition of a physical macro. Finally, depending on the options used, MAP places the design.

MAP first performs a logical DRC (Design Rule Check) on the design in the NGD file. MAP then maps the design logic to the components (logic cells, I/O cells, and other components) in the target Xilinx FPGA.

The output from MAP is an NCD (Native Circuit Description) file a physical representation of the design mapped to the components in the targeted Xilinx FPGA. The mapped NCD file can then be placed and routed using the PAR program.

The following figure shows the MAP design flow:

MAP Design Flow

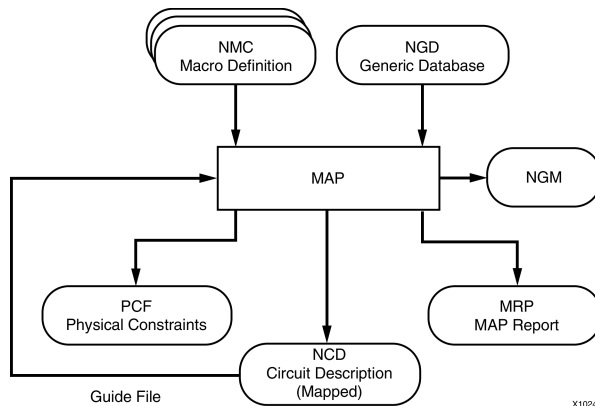

MAP Device Support

This program is compatible with the following device families:

- 7 series
- Spartan®-3, Spartan-3A, Spartan-3E, and Spartan-6
- Virtex®-4, Virtex-5, and Virtex-6

MAP Input Files

MAP uses the following files as input:

- **NGD file** - Native Generic Database (NGD) file. This file contains a logical description of the design expressed both in terms of the hierarchy used when the design was first created and in terms of lower-level Xilinx primitives to which the hierarchy resolves. The file also contains all of the constraints applied to the design during design entry or entered in a UCF (User Constraints File). The NGD file is created by the NGDBuild program.
- **NMC file** - Macro library file. An NMC file contains the definition of a physical macro. When there are macro instances in the NGD design file, NMC files are used to define the macro instances. There is one NMC file for each type of macro in the design file.
- **Guide NCD file** - An optional input file generated from a previous MAP run. An NCD file contains a physical description of the design in terms of the components in the target Xilinx device. A guide NCD file is an output NCD file from a previous MAP run that is used as an input to guide a later MAP run.
- **Guide NGM file** - An optional input file, which is a binary design file containing all of the data in the input NGD file as well as information on the physical design produced by the mapping. See [Guided Mapping](#) for details.
- **Activity files** - An optional input file. MAP supports two activity file formats, `.saif` and `.vcd`.

MAP Output Files

Output from MAP consists of the following files:

- **NCD (Native Circuit Description) file** - A physical description of the design in terms of the components in the target Xilinx device. For a discussion of the output NCD file name and its location, see [-o \(Output File Name\)](#).
- **PCF (Physical Constraints File)** - An ASCII text file that contains constraints specified during design entry expressed in terms of physical elements. The physical constraints in the PCF are expressed in Xilinx constraint language.

MAP creates a PCF file if one does not exist or rewrites an existing file by overwriting the schematic-generated section of the file (between the statements SCHEMATIC START and SCHEMATIC END). For an existing physical constraints file, MAP also checks the user-generated section for syntax errors and signals errors by halting the operation. If no errors are found in the user-generated section, the section is unchanged.

- **NGM file** - A binary design file that contains all of the data in the input NGD file as well as information on the physical design produced by mapping. The NGM file is used to correlate the back-annotated design netlist to the structure and naming of the source design. This file is also used by SmartGuide™ technology.
- **MRP (MAP report)** - A file that contains information about the MAP run. The MRP file lists any errors and warnings found in the design, lists design attributes specified, and details on how the design was mapped (for example, the logic that was removed or added and how signals and symbols in the logical design were mapped into signals and components in the physical design). The file also supplies statistics about component usage in the mapped design. See [MAP Report \(MRP\) File](#) for more details.
- **MAP (MAP Log) file** - A log file which is the log as it is dumped by Map during operation (as opposed to the report file (MRP), which is a formatted file created after Map completes).
- **PSR (Physical Synthesis Report) file** - A file details the optimizations that were done by any of the MAP physical synthesis options. These options include `-global_opt`, `-register_duplication`, `-equivalent_register_removal`, `-logic_opt`, and `-register_duplication`. This report will only get generated if one of these options is enabled.

The MRP, MAP, PCF, and NGM files produced by a MAP run all have the same name as the output NCD file, with the appropriate extension. If the MRP, MAP, PCF, or NGM files already exist, they are overwritten by the new files.

MAP Process

MAP performs the following steps when mapping a design.

1. Selects the target Xilinx® device, package, and speed. MAP selects a part in one of the following ways:
 - Uses the part specified on the MAP command line.
 - If a part is not specified on the command line, MAP selects the part specified in the input NGD file. If the information in the input NGD file does not specify a complete architecture, device, and package, MAP issues an error message and stops. If necessary, MAP supplies a default speed.
2. Reads the information in the input design file.
3. Performs a Logical DRC (Design Rule Check) on the input design. If any DRC errors are detected, the MAP run is aborted. If any DRC warnings are detected, the warnings are reported, but MAP continues to run. The Logical Design Rule

Check (DRC) (also called the NGD DRC) is described in [the Logical Design Rule Check \(DRC\) chapter](#).

Note Step 3 is skipped if the NGD Build DRC was successful.

4. Removes unused logic. All unused components and nets are removed, unless the following conditions exist:
 - A Xilinx Save constraint has been placed on a net during design entry. If an unused net has an S constraint, the net and all used logic connected to the net (as drivers or loads) is retained. All unused logic connected to the net is deleted. For a more complete description of the S constraint, see the [Constraints Guide \(UG625\)](#).
 - The -u option was specified on the MAP command line. If this option is specified, all unused logic is kept in the design.
5. Maps pads and their associated logic into IOBs.
6. Maps the logic into Xilinx components (IOBs, Slices, etc.). The mapping is influenced by various constraints; these constraints are described in the [Constraints Guide \(UG625\)](#).
7. Updates the information received from the input NGD file and write this updated information into an NGM file. This NGM file contains both logical information about the design and physical information about how the design was mapped. The NGM file is used only for back-annotation. For more information, see [Guided Mapping](#).
8. Creates a physical constraints (PCF) file. This is a text file that contains any constraints specified during design entry. If no constraints were specified during design entry, an empty file is created so that you can enter constraints directly into the file using a text editor or indirectly through FPGA Editor.

MAP either creates a PCF file if none exists or rewrites an existing file by overwriting the schematic-generated section of the file (between the statements SCHEMATIC START and SCHEMATIC END). For an existing constraints file, MAP also checks the user-generated section and may either comment out constraints with errors or halt the program. If no errors are found in the user-generated section, the section remains the same.

9. Automatically places the design for all architectures other than Spartan®-3 or Virtex®-4. For MAP to run placement for Spartan-3 or Virtex-4 parts, the **-timing** option must be enabled.
10. Runs a physical Design Rule Check (DRC) on the mapped design. If DRC errors are found, MAP does not write an NCD file.
11. Creates an NCD file, which represents the physical design. The NCD file describes the design in terms of Xilinx components CLBs, IOBs, etc.
12. Writes a MAP report (MRP) file, which lists any errors or warnings found in the design, details how the design was mapped, and supplies statistics about component usage in the mapped design.

MAP Syntax

The following syntax maps your logical design:

```
map [options] infile [.ngd] [pcf_file.pcf]
```

options can be any number of the MAP command line options listed in the [MAP Options](#) section of this chapter. Enter options in any order, preceded them with a dash (minus sign on the keyboard) and separate them with spaces.

infile is the input NGD file name. You do not need to enter the .ngd extension, since map looks for an NGD file as input.

pcf_file is the name of the output Physical Constraints File (PCF). If not specified, the PCF name and location are determined in the following ways:

- If you do not specify a PCF on the command line, the PCF has the same name as the output file but with a `.pcf` extension. The file is placed in the output files directory.
- If you specify a PCF with no path specifier (for example, `cpu_1.pcf` instead of `/home/designs/cpu_1.pcf`), the PCF is placed in the current working directory.
- If you specify a physical constraints file name with a full path specifier (for example, `/home/designs/cpu_1.pcf`), the PCF is placed in the specified directory.
- If the PCF already exists, MAP reads the file, checks it for syntax errors, and overwrites the schematic-generated section of the file. MAP also checks the user-generated section for errors and corrects errors by commenting out physical constraints in the file or by halting the operation. If no errors are found in the user-generated section, the section is unchanged.

Note For a discussion of the output file name and its location, see [-o \(Output File Name\)](#).

MAP Options

This section describes MAP options in more detail. The listing is in alphabetical order.

- -activityfile
- -bp (Map Slice Logic)
- -c (Pack Slices)
- -cm (Cover Mode)
- -detail (Generate Detailed MAP Report)
- -equivalent_register_removal (Remove Redundant Registers)
- -f (Execute Commands File)
- -global_opt (Global Optimization)
- -ignore_keep_hierarchy (Ignore KEEP_HIERARCHY Properties)
- -intstyle (Integration Style)
- -ir (Do Not Use RLOCs to Generate RPMs)
- -filter (Filter File)
- -lc (Lut Combining)
- -logic_opt (Logic Optimization)
- -mt (Multi-Threading)
- -ntd (Non Timing Driven)
- -o (Output File Name)
- -ol (Overall Effort Level)
- -p (Part Number)
- -power (Power Optimization)
- -pr (Pack Registers in I/O)
- -register_duplication (Duplicate Registers)
- -r (Register Ordering)
- -smartguide (SmartGuide)
- -t (Placer Cost Table)
- -timing (Timing-Driven Packing and Placement)
- -u (Do Not Remove Unused Logic)
- -w (Overwrite Existing Files)
- -x (Performance Evaluation Mode)
- -xe (Extra Effort Level)
- -xt (Routing Strategy)

-activityfile (Activity File)

This option lets you specify a switching activity data file to guide power optimizations. This file is the output of a simulation run on the design. For power reduction, MAP uses this file to set frequencies and activity rates signals that are not inputs or outputs, but internal to the design.

Note This option is supported for all FPGA architectures. However, for Spartan®-6, Virtex®-6, and 7 series devices, intelligent clock gating optimization is not affected by the power activity file.

Syntax

-activityfile *activityfile* .vcd|.saif

activityfile is the name of the .vcd or .saif file to use for power optimization.

Note This option is only valid if you also use **-power on** (See [-power \(Power Optimization\)](#)) in the MAP command line.

-bp (Map Slice Logic)

This option enables block RAM mapping.

When block RAM mapping is enabled, MAP attempts to place LUTs and FFs into single-output, single-port block RAMs.

You can create a file containing a list of register output nets that you want converted into block RAM outputs. To instruct MAP to use this file, set the environment variable XIL_MAP_BRAM_FILE to the file name. MAP looks for this environment variable when the -bp option is specified. Only those output nets listed in the file are made into block RAM outputs. Because block RAM outputs are synchronous and can only be reset, the registers packed into a block RAM must also be synchronous reset.

Note Any LUT with an area group constraint will not be placed in block RAM. Any logic to be considered for packing into block RAM must be removed from area groups.

Syntax

-bp

-c (Pack Slices)

This option determines the degree to which slices utilize unrelated packing when the design is mapped.

Note Slice packing and compression are not available if you use **-timing** (timing-driven packing and placement).

Syntax

-c [*packfactor*]

The default value for *packfactor* (no value for **-c**, or **-c** is not specified) is 100.

- For Spartan®-3, Spartan-3A, Spartan-3E, and Virtex®-4 devices when **-timing** is not specified, *packfactor* can be any integer between 0 and 100 (inclusive).
- For Spartan-3, Spartan-3A, Spartan-3E, and Virtex-4 devices when **-timing** is specified, *packfactor* can only be 0, 1 or 100.
- For Spartan-6, Virtex-5, Virtex-6, and 7 series devices, timing-driven packing and placement is always on and *packfactor* can only be 1 or 100.

Note For these architectures, you can also try **-lc (Lut Combining)** to increase packing density.

The *packfactor* (for non-zero values) is the target slice density percentage.

- A *packfactor* value of 0 specifies that only related logic (logic having signals in common) should be packed into a single Slice, and yields the least densely packed design.
- A *packfactor* of 1 results in maximum packing density as the packer is attempting 1% slice utilization.
- A *packfactor* of 100 means that only enough unrelated packs will occur to fit the device with 100% utilization. This results in minimum packing density.

For *packfactor* values from 1 to 100, MAP merges unrelated logic into the same slice only if the design requires denser packing to meet the target slice utilization. If there is no unrelated packing required to fit the device, the number of slices utilized when `-c 100` is specified will equal the number utilized when `-c 0` is specified.

Although specifying a lower *packfactor* results in a denser design, the design may then be more difficult place and route. Unrelated packs can create slices with conflicting placement needs and the denser packing can create local routing congestion.

Note The `-c 1` setting should only be used to determine the maximum density (minimum area) to which a design can be packed. Xilinx® does not recommend using this option in the actual implementation of your design. Designs packed to this maximum density generally have longer run times, severe routing congestion problems in PAR, and poor design performance.

Processing a design with the `-c 0` option is a good way to get a first estimate of the number of Slices required by your design.

-cm (Cover Mode)

This option specifies the criteria used during the cover phase of MAP.

Note This option is not available for Spartan®-6, Virtex®-6, and 7 series architectures.

Syntax

`-cm [area | speed | balanced]`

In this phase, MAP assigns the logic to CLB function generators (LUTs). Use the area, speed, and balanced settings as follows:

area (the default) makes reducing the number of LUTs (and therefore the number of CLBs) the highest priority.

speed has a different effect depending on whether or not there are user specified timing constraints. For designs with user-specified timing constraints, the speed mode makes achieving timing constraints the highest priority and reducing the number of levels of LUTs (the number of LUTs a path passes through) the next priority. For designs with no user-specified timing constraints, the speed mode makes achieving maximum system frequency the highest priority and reducing the number levels of LUTs the next priority. This setting makes it easiest to achieve timing constraints after the design is placed and routed. For most designs, there is a small increase in the number of LUTs (compared to the area setting), but in some cases the increase may be large.

balanced tries to balance the two priorities - achieving timing requirements and reducing the number of LUTs. It produces results similar to the speed setting but avoids the possibility of a large increase in the number of LUTs. For a design with user-specified timing constraints, the balanced mode makes achieving timing constraints the highest priority and reducing the number of LUTs the next priority. For the design with no user-specified timing constraints, the balanced mode makes achieving maximum system frequency the highest priority and reducing the number of LUTs the next priority.

-detail (Generate Detailed MAP Report)

This option enables optional sections in the Map report.

Syntax

`-detail`

When you use `-detail`, DCM and PLL configuration data (Section 12) and information on control sets (Section 13, Virtex®-5 only) are included in the MAP report.

-equivalent_register_removal (Remove Redundant Registers)

This option removes redundant registers.

Note This option is available for Spartan®-6, Virtex®-6, Virtex-5, and Virtex-4 devices only.

Syntax

-equivalent_register_removal {on|off}

With this option **on**, any registers with redundant functionality are examined to see if their removal will increase clock frequencies. By default, this option is **on**.

Note This option is available only when you use [-global_opt \(Global Optimization\)](#).

-f (Execute Commands File)

This option executes the command line arguments in the specified *command_file*.

Syntax

-f *command_file*

For more information on the **-f** option, see [-f \(Execute Commands File\)](#) in the Introduction chapter.

-global_opt (Global Optimization)

This option directs MAP to perform global optimization routines on the fully assembled netlist before mapping the design.

Note This option is available for Spartan®-6, Virtex®-6, Virtex-5, and Virtex-4 devices only. [-register_duplication \(Duplicate Registers\)](#) is disabled if you use this option.

Syntax

-global_opt off | speed | area | power

off (the default) tells MAP not to run global optimization.

speed optimizes for speed.

area optimizes for minimum area (not available for Virtex-4 devices).

power optimizes for minimum power (not available for Virtex-4 devices)

Global optimization includes logic remapping and trimming, logic and register replication and optimization, and logic replacement of 3-state buffers. These routines will extend the runtime of MAP because extra processing occurs. By default this option is off.

Note The **-global_opt power** option can use the activity data supplied via the **-activityfile** option

You cannot use the **-u** option with **-global_opt**. When SmartGuide™ is enabled (**-smartguide**), guide percentages will decrease.

Note See the [-equivalent_register_removal \(Remove Redundant Registers\)](#) option for use with **-global_opt**. See also the [Re-Synthesis and Physical Synthesis Optimizations](#) section of this chapter.

-ignore_keep_hierarchy (Ignore KEEP_HIERARCHY Properties)

This option causes MAP to ignore all "KEEP_HIERARCHY" properties on blocks.

Syntax

`-ignore_keep_hierarchy`

-intstyle (Integration Style)

This option limits screen output, based on the integration style that you are running, to warning and error messages only.

Syntax

`-intstyle ise|xflow|silent`

When using `-intstyle`, one of three modes must be specified:

- `-intstyle ise` indicates the program is being run as part of an integrated design environment.
- `-intstyle xflow` indicates the program is being run as part of an integrated batch flow.
- `-intstyle silent` limits screen output to warning and error messages only.

Note `-intstyle` is automatically invoked when running in an integrated environment such as Project Navigator or XFLOW.

-ir (Do Not Use RLOCs to Generate RPMs)

This option controls how MAP processes RLOC statements.

Syntax

`-ir all|off|place`

`all` disables all RLOC processing.

`off` allows all RLOC processing.

`place` tells MAP to use RLOC constraints to group logic within Slices, but not to generate RPMs (Relationally Placed Macros) controlling the relative placement of Slices.

-filter (Filter File)

This option specifies a filter file, which contains settings to capture and filter messages produced by the program during execution.

Syntax

`-filter [filter_file]`

By default, the filter file name is `filter.filter`.

-lc (Lut Combining)

This option instructs Map to combine two LUT components into a single LUT6 site, utilizing the dual output pins of that site.

Note This option is available for 7 series, Spartan®-6, Virtex®-6, and Virtex-5 devices only.

Syntax

`-lc [off|auto|area]`

off (the default) will disable the LUT Combining feature.
area is the more aggressive option, combining LUTs whenever possible.
auto will attempt to strike a balance between compression and performance.

-logic_opt (Logic Optimization)

This option invokes post-placement logic restructuring for improved timing and design performance.

Syntax

```
-logic_opt on|off
```

The `-logic_opt` option works on a placed netlist to try and optimize timing-critical connections through restructuring and resynthesis, followed by incremental placement and incremental timing analysis. A fully placed, timing optimized NCD design file is produced. Note that this option requires timing-driven mapping, which is enabled with the MAP `-timing` option. When SmartGuide™ is enabled (`-smartguide`), guide percentages will decrease.

Note See also the [Re-Synthesis and Physical Synthesis Optimizations](#) section of this chapter.

-mt (Multi-Threading)

This option lets MAP use more than one processor. It provides multi-threading capabilities to the Placer.

Note This option is available for 7 series, Spartan®-6, Virtex®-6, and Virtex-5 devices only.

Syntax

```
-mt off|2
```

The default is `off`. When `off`, the software uses only one processor. When the value is `2`, the software will use 2 cores if they are available.

-ntd (Non Timing Driven)

This option performs non-timing driven placement.

Syntax

```
-ntd
```

When the `-ntd` switch is enabled, all timing constraints are ignored and the implementation tools do not use any timing information to place and route the design.

Note To run the entire flow without timing constraints, the `-ntd` switch needs to be specified for both MAP and PAR.

-o (Output File Name)

This option specifies the name of the output NCD file for the design.

Syntax

```
-o outfile[.ncd]
```

The `.ncd` extension is optional. The output file name and its location are determined in the following ways:

- If you do not specify an output file name with the `-o` option, the output file has the same name as the input file, with a `.ncd` extension. The file is placed in the input files directory
- If you specify an output file name with no path specifier (for example, `cpu_dec.ncd` instead of `/home/designs/cpu_dec.ncd`), the NCD file is placed in the current working directory.
- If you specify an output file name with a full path specifier (for example, `/home/designs/cpu_dec.ncd`), the output file is placed in the specified directory.
- If the output file already exists, it is overwritten with the new NCD file. You do not receive a warning when the file is overwritten.

Note Signals connected to pads or to the outputs of flip-flops, latches, and RAMS found in the input file are preserved for back-annotation.

-ol (Overall Effort Level)

This option sets the overall MAP effort level. The effort level controls the amount of time used for packing and placement by selecting a more or less CPU-intensive algorithm for placement.

Syntax

`-ol std|high`

- Use **std** for low effort level (fastest runtime at expense of QOR)
- Use **high** for high effort level (best QOR with increased runtime)

The default effort level is **high** for all architectures.

The `-ol` option is available when running timing-driven packing and placement with the `-timing` option.

Note Xilinx® recommends setting the MAP effort level to equal or higher than the PAR effort level.

Example

```
map -timing -ol std design.ncd output.ncd design.pcf
```

This example sets the overall MAP effort level to **std** (fastest runtime at expense of QOR).

-p (Part Number)

This option specifies the part into which your design is implemented.

Syntax

`-p part_number`

Note For syntax details and examples, see `-p (Part Number)` in the Introduction chapter.

If you do not specify a part number, MAP selects the part specified in the input NGD file. If the information in the input NGD file does not specify a complete device and package, you must enter a device and package specification using this option. MAP supplies a default speed value, if necessary.

The architecture you specify must match the architecture specified in the input NGD file. You may have chosen this architecture when you ran NGDBuild or during an earlier step in the design entry process (for example, you may have specified the architecture in the ISE® Design Suite or in your synthesis tool). If the architecture does not match, you must run NGDBuild again and specify the architecture.

-power (Power Optimization)

This option specifies that placement is optimized to reduce power. For Spartan®-6, Virtex®-6, and 7 series devices, you can use the **high** and **xe** options to specify the use of intelligent clock gating algorithms to further reduce power.

Syntax

-power on|off|high|xe

off specifies that no power optimization with a negative effect on runtime, memory or performance will be performed. This is the default option.

on (standard) specifies the use of power optimization algorithms during placement to decrease capacitive loading on data and clocking nets to reduce overall dynamic power. The main trade-off with this option is additional runtime and modified placement, which may result in slightly reduced performance. This option is available for all architectures.

high specifies the use of intelligent clock gating algorithms that reduce overall switching to reduce dynamic power in the design. The main trade-off with this option is additional runtime, minor area increase, increased system memory requirements and additional logic in the data or control paths that can result in reduced performance. However, the power savings is generally more substantial than savings when you use **on** (standard). This option is available for Spartan-6 and Virtex-6, and 7 series devices only.

xe (extra effort) specifies the use of both standard and high algorithms for the greatest reduction in dynamic power optimization. However, this selection generally has the largest impact on runtime, area, memory, and performance. This option is only recommended when you have adequate timing slack in the design and additional runtime and memory can be tolerated. This option is available for Spartan-6 and Virtex-6, and 7 series devices only.

When you use **-power on**, you can also specify a switching activity file to further improve power optimization. For more information see [-activityfile](#).

You can use the **-power** option with the **-global_opt power** switch for additional power optimization and improvement. For more information see [-global_opt](#).

-pr (Pack Registers in I/O)

This option places registers in I/O.

Syntax

-pr off|i|o|b

By default (without the **-pr** option), MAP only places flip-flops or latches within an I/O component if an IOB = TRUE attribute has been applied to the register either by the synthesis tool or by the User Constraints File (.ucf). The **-pr** option specifies that flip-flops or latches may be packed into input registers (i selection), output registers (o selection), or both (b selection) even if the components have not been specified in this way. If this option is not specified, defaults to off. An IOB property on a register, whether set to TRUE or FALSE, will override the **-pr** option for that specific register.

-register_duplication (Duplicate Registers)

This option duplicates registers.

Note `-register_duplication` is disabled if you use `-global_opt`.

Syntax

```
-register_duplication on|off
```

The `-register_duplication` option is only available when running timing-driven packing and placement with the `-timing` option. The `-register_duplication` option duplicates registers to improve timing when running timing-driven packing. See [-timing \(Timing-Driven Packing and Placement\)](#).

-r (Register Ordering)

This option groups registers forming a bus into ordered sequences packed in a slice. The registers are determined to form a bus based on their names.

Syntax

```
-r [4|off|8]
```

`off` disables register ordering.

`4` (the default) uses 4 registers per slice if they are not sourced by a LUT (otherwise uses 8 registers).

`8` uses all 8 registers in the slice.

-smartguide (SmartGuide)

This option instructs the program to use results from a previous implementation to guide the current implementation, based on a placed and routed NCD file. SmartGuide™ technology automatically enables timing-driven packing and placement in MAP (`map -timing`), which improves design performance and timing for highly utilized designs.

You may obtain better results if you use the `map -timing` option to create a placed and routed NCD guide file before enabling SmartGuide technology. SmartGuide technology can be enabled from the command line or from the Hierarchy pane of the Design panel in Project Navigator.

Syntax

```
-smartguide design_name.ncd
```

Note SmartGuide technology will give you a higher guide percentage if an NGM file is available. The NGM file contains information on the transformations done in the MAP process. See the [MAP Process](#) section of this chapter for information on how MAP detects the NGM file.

With SmartGuide technology, all guiding is done in MAP at the BEL level. Guiding includes packing, placement, and routing. SmartGuide technology optimally changes the packing and placement of a design and then routes new nets during PAR. The first goal of SmartGuide technology is to maintain design implementation on the unchanged part and meet timing requirements on the changed part; the second goal is to reduce runtime. Notice that the unchanged part of the implementation will not be changed and therefore will keep the same timing score. Paths that fail timing but do not change should be 100% guided. Paths that fail timing and are changed will be re-implemented.

The results from the MAP run are stored in the output map report file (.mrp). Guide statistics, including the number of guided nets and all new, guided, and re-implemented components are listed in the map report, which is an estimated report. The final statistics are listed in the PAR report file (.par). A separate guide report file (.grf) is generated by PAR. If you use **-smartguide** in the PAR command line, a detailed guide report file is created. If you do not use **-smartguide**, a summary guide report file is created. The guide report file lists components and nets that are re-implemented or new.

The **-timing** option enables all options specific to timing-driven packing and placement. This includes the **-ol** option, which sets the overall effort level used to pack and place the design. See **-ol (Overall Effort Level)** for more information. The following options are enabled when you use **-timing**: **-logic_opt**, **-ntd**, **-ol**, **-register_duplication**, **-x**, and **-xe**. See individual option descriptions in this section for details. See also **-timing (Timing-Driven Packing and Placement)** for more information.

-t (Placer Cost Table)

This option specifies the cost table used by the placer.

Syntax

```
-t [placer_cost_table ]
```

placer_cost_table is the cost table the placer uses (placer cost tables are described in the PAR Chapter). Valid values are 1–100 and the default is 1.

To automatically create implementations using several different cost tables, please refer to the SmartXplorer section in this guide.

Note The **-t** option is only available when running timing-driven packing and placement with the **-timing** option.

-timing (Timing-Driven Packing and Placement)

This option is used to improve design performance. It instructs MAP to do both packing and placement of the design. User-generated timing constraints specified in a UCF/NCF file drive these packing and placement operations.

Note **-timing** is optional for all Spartan®-3 families and Virtex®-4 devices (default is off). It is always on for Spartan-6, Virtex-5, Virtex-6, and 7 series devices.

Syntax

```
-timing
```

When you specify **-timing**, placement occurs in MAP rather than in PAR. Using this option may result in longer runtimes for MAP, though it will reduce the PAR runtime.

Timing-driven packing and placement is recommended to improve design performance, timing, and packing for highly utilized designs. If the unrelated logic number (shown in the Design Summary section of the MAP report) is non-zero, then the **-timing** option is useful for packing more logic in the device. Timing-driven packing and placement is also recommended when there are local clocks present in the design. If timing-driven packing and placement is selected in the absence of user timing constraints, the tools will automatically generate and dynamically adjust timing constraints for all internal clocks. This feature is referred to as Performance Evaluation Mode. See also **-x (Performance Evaluation Mode)** for more information. This mode allows the clock performance for all clocks in the design to be evaluated in one pass. The performance achieved by this mode is not necessarily the best possible performance each clock can achieve, instead it is a balance of performance between all clocks in the design.

The **-timing** option enables all options specific to timing-driven packing and placement. This includes the **-ol** option, which sets the overall effort level used to pack and place the design. See **-ol (Overall Effort Level)** for more information. The following options are enabled when you use **-timing**: **-logic_opt**, **-ntd**, **-ol**, **-register_duplication**, **-x**, and **-xe**. See individual option descriptions in this section for details. See also [Re-Synthesis and Physical Synthesis Optimizations](#) in this chapter for more information.

-u (Do Not Remove Unused Logic)

This option tells MAP not to eliminate unused components and nets from the design.

Syntax

-u

By default (without the **-u** option), MAP eliminates unused components and nets from the design before mapping. Unused logic is logic that is undriven, does not drive other logic, or logic that acts as a “cycle” and affects no device output. When **-u** is specified, MAP applies an “S” (NOCLIP) property to all dangling signals which prevents trimming from initiating at that point and cascading through the design. Dangling components may still be trimmed unless a dangling signal is present to accept the NOCLIP property.

-w (Overwrite Existing Files)

This option instructs MAP to overwrite existing output files, including an existing design file (NCD).

Syntax

-w

-x (Performance Evaluation Mode)

The **-x** option is used if there are timing constraints specified in the user constraints file, and you want to execute a MAP and PAR run with tool-generated timing constraints instead to evaluating the performance of each clock in the design.

Syntax

-x

This operation is referred to as “Performance Evaluation” mode. This mode is entered into either by using the **-x** option or when no timing constraints are used in a design. The tools create timing constraints for each internal clock separately and will tighten/loosen the constraint based on feedback during execution. The MAP effort level controls whether the focus is on fastest run time (STD) or best performance (HIGH).

Note While **-x** ignores all user-generated timing constraints, specified in a UCF/NCF file, all physical constraints such as LOC and AREA_GROUPS are used.

Note The **-x** and **-ntd** switches are mutually exclusive. If user timing constraints are not used, only one automatic timing mode may be selected.

-xe (Extra Effort Level)

The **-xe** option is available when running timing-driven packing and placement with the **-timing** option, and sets the extra effort level.

Syntax

`-xe effort_level`

effort_level can be set to **n** (normal) or **c** (continue). when `-xe` is set to **c**, MAP continues to attempt to improve packing until little or no improvement can be made.

```
map -ol high -xe n design.ncd output.ncd design.pcf
```

-xt (Extra Placer Cost Table)

This option specifies cost tables suited for highly utilized designs. These tables can be used along with the regular cost tables (the `-t` option).

This option is available only for 7 series, Spartan®-6, and Virtex®-6 devices.

Syntax

`-xt cost_table`

cost_table is an integer between 0 and 5 (inclusive) that will select variations of the algorithms to let you more closely optimize them to your design. The default is 0.

Resynthesis and Physical Synthesis Optimizations

MAP provides options that enable advanced optimizations that are capable of improving timing results beyond standard implementations. These advanced optimizations can transform the design prior to or after placement.

Optimizations can be applied at two different stages in the Xilinx® design flow. The first stage happens right after the initial mapping of the logic to the architecture slices. The MAP `-global_opt` option directs MAP to perform global optimization routines on a fully mapped design, before placement. See [-global_opt \(Global Optimization\)](#) for more information.

The second stage where optimizations can be applied is after placement, when paths that do not meet timing are evaluated and re-synthesized. MAP takes the initial netlist, places it, and then analyzes the timing of the design. When timing is not met, MAP performs physical synthesis optimizations and transforms the netlist to meet timing. To enable physical synthesis optimizations, timing-driven placement and routing (`-timing`) must be enabled.

Physical synthesis optimizations are enabled with the `-logic_opt` ([Logic Optimization](#)) and `-register_duplication` ([Duplicate Registers](#)) options. See the [MAP Options](#) section of this chapter for more information on the available options.

Guided Mapping

In guided mapping, an existing NCD is used to guide the current MAP run. The guide file may be from any stage of implementation: unplaced or placed, unrouted or routed. Xilinx® recommends generating an NCD file using the current release of the software. Using a guide file generated by a previous software release usually works, but may not be supported.

Note When using guided mapping with the `-timing` option, Xilinx recommends using a placed NCD as the guide file. A placed NCD is produced by running MAP with the `-timing` option, or running PAR.

SmartGuide™ technology allows results from a previous implementation to guide the next implementation. When SmartGuide is used, MAP and PAR processes use the NCD file, specified with the `-smartguide` option, to guide the new and re-implemented components and nets. SmartGuide technology may move guided components and nets to meet timing. The first goal of SmartGuide technology is to meet timing requirements; the second goal is to reduce runtime.

SmartGuide technology works best at the end of the design cycle when timing is met and small design changes are being made. If the design change is to a path that is difficult to meet timing, the best performance will be obtained without SmartGuide technology. Other examples of design changes that work well with SmartGuide technology are:

- Changes to pin locations
- Changes to attributes on instantiated components
- Changes for relaxing timing constraints
- Changes for adding a ChipScope™ core

In this release of Xilinx software, SmartGuide has replaced the `-gm` and `-gf` options.

Note See [-smartguide \(SmartGuide\)](#) for more information.

MAP uses the NGM and the NCD files as guides. The NGM file contains information on the transformations done in the MAP process. You do not need to specify the NGM file on the command line. MAP infers the appropriate NGM file from the specified NCD guide file. If no match is found, MAP looks for the appropriate NGM file based on the embedded name, which may include the full path and name. If MAP does not find an NGM file in the same directory as the NCD, the current directory, or based on the embedded name, it generates a warning. In this case, MAP uses only the NCD file as the guide file, which may be less effective.

Note SmartGuide will have a higher guide percentage if the NGM file is available.

The results from the MAP run are stored in the output map report file (`.mrp`). Guide statistics, including the number of guided nets and all new, guided, and re-implemented components are listed in the map report, which is an estimated report. The final statistics are listed in the output PAR report. PAR generates a separate guide report file (`.grf`) when you use the `-smartguide` option on the PAR command line. The GRF file is a detailed report that lists components that are re-implemented or new. It also lists nets.

Note See [-smartguide \(SmartGuide\)](#) for more information and other switch interactions.

Simulating Map Results

When simulating with NGC files, you are not simulating a mapped result, you are simulating the logical circuit description. When simulating with NCD files, you are simulating the physical circuit description.

MAP may generate an error that is not detected in the back-annotated simulation netlist. For example, after running MAP, you can run the following command to generate the back-annotated simulation netlist:

```
netgen mapped.ncd mapped.ngm -o mapped.nga
```

This command creates a back-annotated simulation netlist using the logical-to-physical cross-reference file named `mapped.ngm`. This cross-reference file contains information about the logical design netlist, and the back-annotated simulation netlist (`mapped.nga`) is actually a back-annotated version of the logical design. However, if MAP makes a physical error, for example, implements an Active Low function for an Active High function, this error will not be detected in the `mapped.nga` file and will not appear in the simulation netlist.

For example, consider the following logical circuit generated by NGDBuild from a design file, shown in the following figure.

Logical Circuit Representation

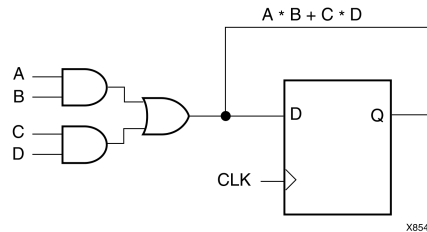

Observe the Boolean output from the combinational logic. Suppose that after running MAP for the preceding circuit, you obtain the following result.

CLB Configuration

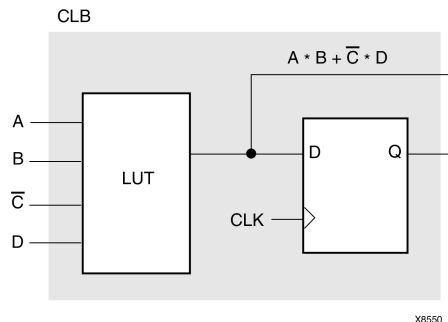

Observe that MAP has generated an active low (C) instead of an active high (C). Consequently, the Boolean output for the combinational logic is incorrect. When you run NetGen using the mapped.ngm file, you cannot detect the logical error because the delays are back-annotated to the correct logical design, and not to the physical design.

One way to detect the error is by running the NetGen command without using the mapped.ngm cross-reference file.

```
netgen mapped.ncd -o mapped.nga
```

As a result, physical simulations using the mapped.nga file should detect a physical error. However, the type of error is not always easily recognizable. To pinpoint the error, use FPGA Editor or call Xilinx® Customer Support. In some cases, a reported error may not really exist, and the CLB configuration is actually correct. You can use FPGA Editor to determine if the CLB is correctly modeled.

Finally, if both the logical and physical simulations do not discover existing errors, you may need to use more test vectors in the simulations.

MAP Report (MRP) File

The MAP report (MRP) file is an ASCII text file that contains information about the MAP run. The report information varies based on the device and whether you use the **-detail** option (see the [-detail \(Generate Detailed MAP Report\)](#) section).

An abbreviated MRP file is shown below most report files are considerably larger than the one shown. The file is divided into a number of sections, and sections appear even if they are empty. The sections of the MRP file are as follows:

- **Design Information** - Shows your MAP command line, the device to which the design has been mapped, and when the mapping was performed.

- **Design Summary** - Summarizes the mapper run, showing the number of errors and warnings, and how many of the resources in the target device are used by the mapped design.
- **Table of Contents** - Lists the remaining sections of the MAP report.
- **Errors** - Shows any errors generated as a result of the following:
 - Errors associated with the logical DRC tests performed at the beginning of the mapper run. These errors do not depend on the device to which you are mapping.
 - Errors the mapper discovers (for example, a pad is not connected to any logic, or a bidirectional pad is placed in the design but signals only pass in one direction through the pad). These errors may depend on the device to which you are mapping.
 - Errors associated with the physical DRC run on the mapped design.
- **Warnings** - Shows any warnings generated as a result of the following:
 - Warnings associated with the logical DRC tests performed at the beginning of the mapper run. These warnings do not depend on the device to which you are mapping.
 - Warnings the mapper discovers. These warnings may depend on the device to which you are mapping.
 - Warnings associated with the physical DRC run on the mapped design.
- **Informational** - Shows messages that usually do not require user intervention to prevent a problem later in the flow. These messages contain information that may be valuable later if problems do occur.
- **Removed Logic Summary** - Summarizes the number of blocks and signals removed from the design. The section reports on these kinds of removed logic.
- **Removed Logic** - Describes in detail all logic (design components and nets) removed from the input NGD file when the design was mapped. Generally, logic is removed for the following reasons:
 - The design uses only part of the logic in a library macro.
 - The design has been mapped even though it is not yet complete.
 - The mapper has optimized the design logic.
 - Unused logic has been created in error during schematic entry.

This section also indicates which nets were merged (for example, two nets were combined when a component separating them was removed).

In this section, if the removal of a signal or symbol results in the subsequent removal of an additional signal or symbol, the line describing the subsequent removal is indented. This indentation is repeated as a chain of related logic is removed. To quickly locate the cause for the removal of a chain of logic, look above the entry in which you are interested and locate the top-level line, which is not indented.
- **IOB Properties** - Lists each IOB to which the user has supplied constraints along with the applicable constraints.
- **RPMs** - Indicates each Relationally Placed Macro (RPM) used in the design, and the number of device components used to implement the RPM.
- **SmartGuide Report** - If you have mapped using SmartGuide™ technology, this section shows the estimated results obtained using SmartGuide technology, which is the estimated percentage of components and nets that were guided. SmartGuide technology results in the MAP report are estimated. SmartGuide technology results in the PAR report are accurate. See the [ReportGen](#) section of the PAR chapter for more information.

- **Area Group & Partition Summary** - The mapper summarizes results for each area group or partition found in the design. MAP uses area groups to specify a group of logical blocks that are packed into separate physical areas. If no area groups or partitions are found in the design, the MAP report states this.
- **Timing Report** - This section, produced with the `-timing` option, shows information on timing constraints considered during the MAP run. This report is not generated by default. This report is only generated when the `-detail` switch is specified.
- **Configuration String Information** - This section, produced with the `-detail` option, shows configuration strings and programming properties for special components like DCMs, BRAMS, GTs and similar components. DCM and PLL reporting are available. Configuration strings for slices and IOBs marked SECURE are not shown. This report is not generated by default. This report is only generated when the `-detail` switch is specified.
- **Control Set Information** - This section controls the set information that is written only for Virtex®-5 devices. This report is not generated by default. This report is only generated when the `-detail` switch is specified.
- **Utilization by Hierarchy** - This section is controls the utilization hierarchy only for Virtex-4, Virtex-5, and Spartan®-3 architectures. This report is not generated by default. This report is only generated when the `-detail` switch is specified.

Note The MAP Report is formatted for viewing in a monospace (non-proportional) font. If the text editor you use for viewing the report uses a proportional font, the columns in the report do not line up correctly.

Note The MAP Report generates a pinout table with pins including the values DIFFSI, DIFFMI, and _NDT.

MAP Report Example 1

Xilinx Mapping Report File for Design 'wave_gen'

Design Information

```
-----
Command Line   : map -intstyle ise -p xc6vlx75t-ff484-1 -w -ol high -t 1 -xt 0 -register_duplication off -global_opt off
-mt off -ir off -pr o -lc off -power off -o wave_gen_map.ncd wave_gen.ngd wave_gen.pcf
Target Device  : xc6vlx75t
Target Package : ff484
Target Speed   : -1
Mapper Version : virtex6 -- $Revision: 1.52 $
Mapped Date    : Thu Feb 25 16:16:02 2010
```

Design Summary

```
-----
Number of errors:      0
Number of warnings:   0
Slice Logic Utilization:
  Number of Slice Registers:          569 out of  93,120    1%
    Number used as Flip Flops:        568
    Number used as Latches:            1
    Number used as Latch-thrus:        0
    Number used as AND/OR logics:      0
  Number of Slice LUTs:              958 out of  46,560    2%
    Number used as logic:              854 out of  46,560    1%
      Number using O6 output only:     658
      Number using O5 output only:     15
      Number using O5 and O6:          181
      Number used as ROM:               0
    Number used as Memory:             0 out of  16,720    0%
  Number used exclusively as route-thrus: 104
    Number with same-slice register load: 102
    Number with same-slice carry load:   2
    Number with other load:             0
Slice Logic Distribution:
  Number of occupied Slices:          328 out of  11,640    2%
```

Number of LUT Flip Flop pairs used:	988		
Number with an unused Flip Flop:	569 out of	988	57%
Number with an unused LUT:	30 out of	988	3%
Number of fully used LUT-FF pairs:	389 out of	988	39%
Number of unique control sets:	52		
Number of slice register sites lost to control set restrictions:	223 out of	93,120	1%

A LUT Flip Flop pair for this architecture represents one LUT paired with one Flip Flop within a slice. A control set is a unique combination of clock, reset, set, and enable signals for a registered element. The Slice Logic Distribution report is not meaningful if the design is over-mapped for a non-slice resource or if Placement fails. OVERMAPPING of BRAM resources should be ignored if the design is over-mapped for a non-BRAM resource or if placement fails.

IO Utilization:			
Number of bonded IOBs:	17 out of	240	7%
IOB Flip Flops:	11		

Specific Feature Utilization:			
Number of RAMB36E1/FIFO36E1s:	0 out of	156	0%
Number of RAMB18E1/FIFO18E1s:	2 out of	312	1%
Number using RAMB18E1 only:	2		
Number using FIFO18E1 only:	0		
Number of BUFG/BUFGCTRLs:	3 out of	32	9%
Number used as BUFGs:	3		
Number used as BUFGCTRLs:	0		
Number of ILOGICE1/ISERDESE1s:	0 out of	360	0%
Number of OLOGICE1/OSERDESE1s:	11 out of	360	3%
Number used as OLOGICE1s:	11		
Number used as OSERDESE1s:	0		
Number of BSCANS:	0 out of	4	0%
Number of BUFHCEs:	1 out of	72	1%
Number of BUFOs:	0 out of	18	0%
Number of BUFIODQs:	0 out of	36	0%
Number of BUFRs:	0 out of	18	0%
Number of CAPTUREs:	0 out of	1	0%
Number of DSP48E1s:	0 out of	288	0%
Number of EFUSE_USRs:	0 out of	1	0%
Number of GTXE1s:	0 out of	8	0%
Number of IBUFDS_GTXE1s:	0 out of	6	0%
Number of ICAPs:	0 out of	2	0%
Number of IDELAYCTRLs:	0 out of	9	0%
Number of IODELAYE1s:	0 out of	360	0%
Number of MMCM_ADVs:	1 out of	6	16%
Number of PCIE_2_0s:	0 out of	1	0%
Number of STARTUPs:	0 out of	1	0%
Number of SYSMONs:	0 out of	1	0%
Number of TEMAC_SINGLES:	0 out of	4	0%

Average Fanout of Non-Clock Nets:	3.95
-----------------------------------	------

Peak Memory Usage: 727 MB
 Total REAL time to MAP completion: 1 mins 10 secs
 Total CPU time to MAP completion: 1 mins 5 secs

Table of Contents

 Section 1 - Errors
 Section 2 - Warnings
 Section 3 - Informational
 Section 4 - Removed Logic Summary
 Section 5 - Removed Logic
 Section 6 - IOB Properties
 Section 7 - RPMs
 Section 8 - Guide Report
 Section 9 - Area Group and Partition Summary
 Section 10 - Timing Report
 Section 11 - Configuration String Information
 Section 12 - Control Set Information
 Section 13 - Utilization by Hierarchy

Section 1 - Errors

Section 2 - Warnings

Section 3 - Informational

```

INFO:LIT:243 - Logical network uart_rx_i0/frm_err has no load.
INFO:MapLib:564 - The following environment variables are currently set:
INFO:MapLib:591 - XIL_MAP_NODRC Value: 1
INFO:LIT:244 - All of the single ended outputs in this design are using slew
rate limited output drivers. The delay on speed critical single ended outputs
can be dramatically reduced by designating them as fast outputs.
INFO:Pack:1716 - Initializing temperature to 85.000 Celsius. (default - Range:
0.000 to 85.000 Celsius)
INFO:Pack:1720 - Initializing voltage to 0.950 Volts. (default - Range: 0.950 to
1.050 Volts)
INFO:Timing:3386 - Intersecting Constraints found and resolved.
For more information, see the TSI report. Please consult the Xilinx
Command Line Tools User Guide for information on generating a TSI report.
INFO:Map:215 - The Interim Design Summary has been generated in the MAP Report
(.mrp).
INFO:Pack:1650 - Map created a placed design.

```

Section 4 - Removed Logic Summary

```

4 block(s) removed
21 block(s) optimized away
2 signal(s) removed

```

Section 5 - Removed Logic

The trimmed logic report below shows the logic removed from your design due to sourceless or loadless signals, and VCC or ground connections. If the removal of a signal or symbol results in the subsequent removal of an additional signal or symbol, the message explaining that second removal will be indented. This indentation will be repeated as a chain of related logic is removed.

To quickly locate the original cause for the removal of a chain of logic, look above the place where that logic is listed in the trimming report, then locate the lines that are least indented (begin at the leftmost edge).

```

The signal "uart_rx_i0/frm_err" is sourceless and has been removed.
The signal "DAC_SPI_controller_i0/out_ddr_flop_spi_clk_i0/N1" is sourceless and
has been removed.
Unused block "char_fifo_i0/GND" (ZERO) removed.
Unused block "char_fifo_i0/VCC" (ONE) removed.
Unused block "samp_ram_i0/GND" (ZERO) removed.
Unused block "samp_ram_i0/VCC" (ONE) removed.

```

Optimized Block(s):

```

TYPE    BLOCK
GND     XST_GND
GND     char_fifo_i0/BU2/XST_GND
VCC     char_fifo_i0/BU2/XST_VCC
GND     samp_ram_i0/BU2/XST_GND
VCC     samp_ram_i0/BU2/XST_VCC
VCC     DAC_SPI_controller_i0/XST_VCC
GND     DAC_SPI_controller_i0/out_ddr_flop_spi_clk_i0/XST_GND
VCC     DAC_SPI_controller_i0/out_ddr_flop_spi_clk_i0/XST_VCC
GND     clk_gen_i0/clk_core_i0/XST_GND
VCC     clk_gen_i0/clk_core_i0/XST_VCC
GND     clk_gen_i0/clk_div_i0/XST_GND
VCC     clk_gen_i0/clk_div_i0/XST_VCC
VCC     cmd_parse_i0/XST_VCC
VCC     resp_gen_i0/XST_VCC
GND     resp_gen_i0/to_bcd_i0/XST_GND
VCC     resp_gen_i0/to_bcd_i0/XST_VCC
GND     rst_gen_i0/reset_bridge_clk_clk_samp_i0/XST_GND
GND     rst_gen_i0/reset_bridge_clk_rx_i0/XST_GND
GND     rst_gen_i0/reset_bridge_clk_tx_i0/XST_GND

```

```
GND samp_gen_i0/XST_GND
VCC samp_gen_i0/XST_VCC
```

To enable printing of redundant blocks removed and signals merged, set the detailed map report option and rerun map.

Section 6 - IOB Properties

IOB Name	Type	Direction	IO Standard	Diff Term	Drive Strength	Slew Rate	Reg (s)	Resistor	IOB Delay
DAC_clr_n_pin	IOB	OUTPUT	LVCOS25		12	SLOW	OFF		
DAC_cs_n_pin	IOB	OUTPUT	LVCOS25		12	SLOW			
SPI_MOSI_pin	IOB	OUTPUT	LVCOS25		12	SLOW	OFF		
clk_pin	IOB	INPUT	LVCOS25						
lb_sel_pin	IOB	INPUT	LVCOS25						
led_pins<0>	IOB	OUTPUT	LVCOS25		12	SLOW	OFF		
led_pins<1>	IOB	OUTPUT	LVCOS25		12	SLOW	OFF		
led_pins<2>	IOB	OUTPUT	LVCOS25		12	SLOW	OFF		
led_pins<3>	IOB	OUTPUT	LVCOS25		12	SLOW	OFF		
led_pins<4>	IOB	OUTPUT	LVCOS25		12	SLOW	OFF		
led_pins<5>	IOB	OUTPUT	LVCOS25		12	SLOW	OFF		
led_pins<6>	IOB	OUTPUT	LVCOS25		12	SLOW	OFF		
led_pins<7>	IOB	OUTPUT	LVCOS25		12	SLOW	OFF		
rst_pin	IOB	INPUT	LVCOS25						
rxn_pin	IOB	INPUT	LVCOS25						
spi_clk_pin	IOB	OUTPUT	LVCOS25		12	SLOW	ODDR		
txd_pin	IOB	OUTPUT	LVCOS25		12	SLOW			

Section 7 - RPMs

Section 8 - Guide Report

Guide not run on this design.

Section 9 - Area Group and Partition Summary

Partition Implementation Status

No Partitions were found in this design.

Area Group Information

No area groups were found in this design.

Section 10 - Timing Report

A logic-level (pre-route) timing report can be generated by using Xilinx static timing analysis tools, Timing Analyzer (GUI) or TRCE (command line), with the mapped NCD and PCF files. Please note that this timing report will be generated using estimated delay information. For accurate numbers, please generate a timing report with the post Place and Route NCD file.

For more information about the Timing Analyzer, consult the Xilinx Timing Analyzer Reference Manual; for more information about TRCE, consult the Xilinx Command Line Tools User Guide "TRACE" chapter.

Section 11 - Configuration String Details

Use the "-detail" map option to print out Configuration Strings

Section 12 - Control Set Information

 Use the "--detail" map option to print out Control Set Information.

Section 13 - Utilization by Hierarchy

Use the "--detail" map option to print out the Utilization by Hierarchy section.

Physical Synthesis Report (PSR) File

The Physical Synthesis report (PSR) file is an ASCII text file that contains information about the following MAP options:

- Global optimization (**-global_opt**)
- Equivalent Register Removal (**-equivalent_register_removal**)
- Combinatorial Logic Optimization (**-logic_opt**)
- Register Duplication (**-register_duplication**)
- Power fine grain slice clock gating optimization (**-power_high** or **-power_xe**)

The first part of the report provides information on all of the options except -power, and contains three sections:

- **Physical Synthesis Options Summary** - Shows the physical options that were used for the implementation and the target device for the implementation.
- **Optimizations Statistics** - Summarizes the number of registers and SRLs added/removed due to the physical synthesis optimizations.
- **Optimization Details** - Lists the new or modified instances, the optimizations that impacted that instance, and the overall objective for that optimization.

The possible optimizations that can impact an instance and the overall objective for each optimization are:

Optimization	Objective	Option Causing Optimization
SRL Inferencing	Area	-global_opt
Synchronous Optimization	Performance	-global_opt speed
Reduce Maximum Fanout	Fanout Optimization	-register_duplication + MAX_FANOUT constraint
Replication	Fanout Optimization	-register_duplication + MAX_FANOUT constraint
Equivalence Removal	Complexity	-equivalent_register_removal
Trimming	Complexity	-global_opt
SmartOpt Trimming	Area	-global_opt area

If you use the **-power_high** or **-power_xe** option, the report will include three additional sections:

- **Power Opt Slice clock gating summary** - Shows the option used.
- **Optimization Statistics** - Summarizes slice register gated and clock enable nets processed.
- **Optimization Details** - Lists the modified component instance names, their type, their respective clock enable net names and the optimization objective (power).

PSR Report Example

The following example PSR report shows all of the sections available, but to save space has been shortened to show only the first few "SmartOpt Trimming" entries.

TABLE OF CONTENTS

- 1) Physical Synthesis Options Summary
- 2) Optimizations statistics and details

```

=====
*           Physical Synthesis Options Summary           *
=====
---- Options
Global Optimization           : ON
  Equivalent Register Removal : ON
Timing-Driven Packing and Placement : ON
  Logic Optimization         : ON
  Register Duplication       : ON

---- Intelligent clock gating       : ON

---- Target Parameters
Target Device                 : 6slx45tfgg484-2
=====

```

```

=====
*           Optimizations           *
=====
---- Statistics
Number of LUTs removed by SmartOpt Trimming      | 845
Number of registers removed by Equivalence Removal | 5
Number of registers removed by SmartOpt Trimming  | 9
Number of LUTs removed by Trimming              | 13

Overall change in number of design objects        | -872

Number of Slice registers gated                   : 20
Number of BRAM Ports gated                       : 0
Number of clock enable net processed              : 7

```

---- Details

Removed components	Optimization
Mmux_internal_count_m_1[3]_PWR_16_o_mux_4_OUT112	Trimming
Mmux_internal_count_m_1[3]_PWR_16_o_mux_4_OUT113	Trimming
Mmux_internal_count_m_1[3]_PWR_16_o_mux_4_OUT212	Trimming
Mmux_internal_count_m_1[3]_PWR_16_o_mux_4_OUT213	Trimming
Mmux_internal_count_m_1[3]_PWR_16_o_mux_4_OUT312	Trimming
Mmux_internal_count_m_1[3]_PWR_16_o_mux_4_OUT313	Trimming
Mmux_internal_count_m_1[3]_PWR_16_o_mux_4_OUT412	Trimming
Mmux_internal_count_m_1[3]_PWR_16_o_mux_4_OUT413	Trimming
Mmux_rmn4205_SW1_F	SmartOpt Trimming
Mmux_rmn4205_SW1_G	SmartOpt Trimming
Mmux_txd_o112	Trimming
U0/grf.rf/g10.rd/gr1.rfwft/empty_fwft_fb	Equivalence Removal
U0/grf.rf/g10.rd/gr1.rfwft/empty_fwft_i	SmartOpt Trimming
U0/grf.rf/g10.rd/rpntr/gc0.count_0	SmartOpt Trimming
U0/grf.rf/g10.wr/gwas.wsts/ram_full_fb_i	Equivalence Removal
U0/grf.rf/g10.wr/wpntr/gic0.gc0.count_0	SmartOpt Trimming
U0/grf.rf/g10.wr/wpntr/gic0.gc0.count_d2_0	SmartOpt Trimming
U0/grf.rf/g10.wr/wpntr/gic0.gc0.count_d2_1	SmartOpt Trimming
U0/grf.rf/rstblk/ngwdrst.grst.rd_rst_reg_0	Equivalence Removal
U0/grf.rf/rstblk/ngwdrst.grst.rd_rst_reg_1	Equivalence Removal
U0/grf.rf/rstblk/ngwdrst.grst.wr_rst_reg_0	Equivalence Removal
U0/grf.rf/rstblk/wr_rst_asreg	SmartOpt Trimming
U0/grf.rf/rstblk/wr_rst_asreg_d1	SmartOpt Trimming
U0/grf.rf/rstblk/wr_rst_asreg_d2	SmartOpt Trimming
][102_891	SmartOpt Trimming
][103_1029	SmartOpt Trimming
][103_938	SmartOpt Trimming
][104_1197	SmartOpt Trimming
][107_1033	SmartOpt Trimming

Halting MAP

To halt MAP, enter Ctrl-C (on a workstation) or Ctrl-Break (on a PC). On a workstation, make sure that when you enter Ctrl-C the active window is the window from which you invoked the mapper. The operation in progress is halted. Some files may be left when the mapper is halted (for example, a MAP report file or a physical constraints file), but these files may be discarded since they represent an incomplete operation.

Physical Design Rule Check

The chapter describes the physical Design Rule Check program.

DRC Overview

The physical Design Rule Check, also known as DRC, comprises a series of tests to discover physical errors and some logic errors in the design. The physical DRC is run as follows:

- MAP automatically runs physical DRC after it has mapped the design.
- Place and Route (PAR) automatically runs physical DRC on nets when it routes the design.
- BitGen, which creates a BIT file for programming the device, automatically runs physical DRC.
- You can run physical DRC from within FPGA Editor. The DRC also runs automatically after certain FPGA Editor operations (for example, when you edit a logic cell or when you manually route a net). For a description of how the DRC works within FPGA Editor, see the online help provided with FPGA Editor.
- You can run physical DRC from the Linux or DOS command line.

Device Support

This program is compatible with the following device families:

- 7 series
- Spartan®-3, Spartan-3A, Spartan-3E, and Spartan-6
- Virtex®-4, Virtex-5, and Virtex-6

DRC Input File

The input to DRC is an NCD file. The NCD file is a mapped, physical description of your design.

DRC Output File

The output of DRC is a TDR file. The TDR file is an ASCII formatted DRC report. The contents of this file are determined by the command line options you specify with the DRC command.

DRC Syntax

The following command runs physical DRC:

```
drc [options] file_name.ncd
```

- *options* can be any number of the DRC options listed in [DRC Options](#). Enter options in any order, preceded them with a dash (minus sign on the keyboard) and separate them with spaces.
- *file_name* is the name of the NCD file on which DRC is to be run.

DRC Options

This section describes the DRC command line options.

- [-e \(Error Report\)](#)
- [-o \(Output file\)](#)
- [-s \(Summary Report\)](#)
- [-v \(Verbose Report\)](#)
- [-z \(Report Incomplete Programming\)](#)

-e (Error Report)

This option produces a report containing details about errors only. No details are given about warnings.

Syntax

```
-e
```

-o (Output file)

This option overrides the default output report file *file_name.tdr* with *outfile_name.tdr*.

Syntax

```
-o outfile_name.tdr
```

-s (Summary Report)

This option produces a summary report only. The report lists the number of errors and warnings found but does not supply any details about them.

Syntax

```
-s
```

-v (Verbose Report)

This option reports all warnings and errors. This is the default option for DRC.

Syntax

```
-v
```

-z (Report Incomplete Programming)

This option reports incomplete programming as errors. Certain DRC violations are considered errors when the DRC runs as part of the BitGen command but are considered warnings at all other times the DRC runs. These violations usually indicate the design is incompletely programmed (for example, a logic cell has been only partially programmed or a signal has no driver). The violations create errors if you try to program the device, so they are reported as errors when BitGen creates a BIT file for device programming. If you run DRC from the command line without the -z option, these violations are reported as warnings only. With the -z option, these violations are reported as errors.

Syntax

-z

DRC Checks

Physical DRC performs the following types of checks:

- Net check
This check examines one or more routed or unrouted signals and reports any problems with pin counts, 3-state buffer inconsistencies, floating segments, antennae, and partial routes.
- Block check
This check examines one or more placed or unplaced components and reports any problems with logic, physical pin connections, or programming.
- Chip check
This check examines a special class of checks for signals, components, or both at the chip level, such as placement rules with respect to one side of the device.
- All checks
This check performs net, block, and chip checks.

When you run DRC from the command line, it automatically performs net, block, and chip checks.

In FPGA Editor, you can run the net check on selected objects or on all of the signals in the design. Similarly, the block check can be performed on selected components or on all of the design's components. When you check all components in the design, the block check performs extra tests on the design as a whole (for example, 3-state buffers sharing long lines and oscillator circuitry configured correctly) in addition to checking the individual components. In FPGA Editor, you can run the net check and block check separately or together.

DRC Errors and Warnings

A DRC error indicates a condition in which the routing or component logic does not operate correctly (for example, a net without a driver or a logic block that is incorrectly programmed). A DRC warning indicates a condition where the routing or logic is incomplete (for example, a net is not fully routed or a logic block has been programmed to process a signal but there is no signal on the appropriate logic block pin).

Certain messages may appear as either warnings or errors, depending on the application and signal connections. For example, in a net check, a pull-up not used on a signal connected to a decoder generates an error message. A pull-up not used on a signal connected to a 3-state buffer only generates a warning.

Incomplete programming (for example, a signal without a driver or a partially programmed logic cell) is reported as an error when the DRC runs as part of the BitGen command, but is reported as a warning when the DRC runs as part of any other program. The -z option to the DRC command reports incomplete programming as an error instead of a warning. For a description of the -z option, see -z ([Report Incomplete Programming](#)).

Place and Route (PAR)

After you create a Native Circuit Description (NCD) file with the MAP program, you can place and route that design file using PAR.

PAR Overview

PAR accepts a mapped NCD file as input, places and routes the design, and outputs an NCD file to be used by the bitstream generator (BitGen). See the BitGen chapter.

The NCD file output by PAR can also be used as a guide file for additional runs of SmartGuide™ in MAP and PAR that may be done after making minor changes to your design. See the [-smartguide \(SmartGuide\)](#) section. PAR places and routes a design based on the following considerations:

- **Timing-driven** - The Xilinx® timing analysis software enables PAR to place and route a design based upon timing constraints.
- **Non Timing-driven (cost-based)** - Placement and routing are performed using various cost tables that assign weighted values to relevant factors such as constraints, length of connection, and available routing resources. Non timing-driven placement and routing is used if no timing constraints are present.

The design flow through PAR is shown in the following figure. This figure shows a PAR run that produces a single output design file (NCD).

PAR Flow

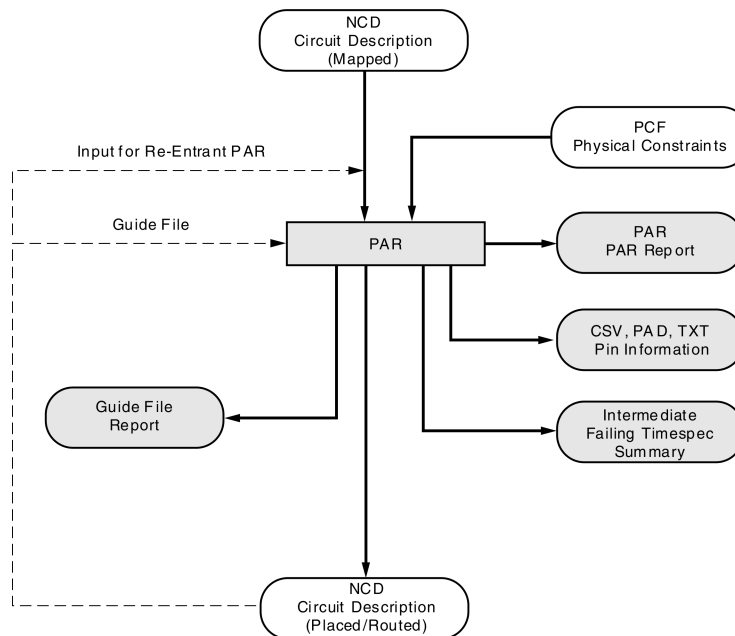

X1009 0

PAR Device Support

This program is compatible with the following device families:

- 7 series
- Spartan®-3, Spartan-3A, Spartan-3E, and Spartan-6
- Virtex®-4, Virtex-5, and Virtex-6

PAR Input Files

Input to PAR consists of the following files:

- **NCD file** - The Native Circuit Description (NCD) file is a mapped design file.
- **PCF file** - The Physical Constraints File (PCF) is an ASCII file containing constraints based on timing, physical placements, and other attributes placed in a UCF or NCF file. PAR supports all of the timing constraints described in the [Constraints Guide \(UG625\)](#).
- **Guide NCD file** - An optional placed and routed NCD file you can use as a guide for placing and routing the design.

PAR Output Files

Output from PAR consists of the following files:

- NCD file — a placed and routed design file (may contain placement and routing information in varying degrees of completion).
- PAR file — a PAR report including summary information of all placement and routing iterations.
- PAD file — a file containing I/O pin assignments in a parsable database format.
- CSV file — a file containing I/O pin assignments in a format supported by spreadsheet programs.
- TXT file — a file containing I/O pin assignments in a ASCII text version for viewing in a text editor.
- XRPT file — an XML file format that contains the report data found in various reports produced during the par invocation
- UNROUTES file — a file containing a list of any unrouted signals.

PAR Process

This section provides information on how placing and routing are performed by PAR, as well as information on timing-driven PAR and automatic timespecing.

Placing

The PAR placer executes multiple phases of the placer. PAR writes the NCD after all the placer phases are complete.

During placement, PAR places components into sites based on factors such as constraints specified in the PCF file, the length of connections, and the available routing resources.

If MAP was run with `-timing` (Timing Driven Packing and Placement) enabled, placement has already occurred in MAP and therefore, PAR will only route the design.

Routing

After placing the design, PAR executes multiple phases of the router. The router performs a converging procedure for a solution that routes the design to completion and meets timing constraints. Once the design is fully routed, PAR writes an NCD file, which can be analyzed against timing.

PAR writes a new NCD as the routing improves throughout the router phases.

Note Timing-driven place and timing-driven routing are automatically invoked if PAR finds timing constraints in the physical constraints file.

Timing Driven PAR

Timing-driven PAR is based on the Xilinx® timing analysis software, an integrated static timing analysis tool that does not depend on input stimulus to the circuit. Placement and routing are executed according to timing constraints that you specify in the beginning of the design process. The timing analysis software interacts with PAR to ensure that the timing constraints imposed on your design are met.

To use timing-driven PAR, you can specify timing constraints using any of the following ways:

- Enter the timing constraints as properties in a schematic capture or HDL design entry program. In most cases, an NCF will be automatically generated by the synthesis tool.
- Write your timing constraints into a User Constraints File (UCF). This file is processed by NGDBuild when the logical design database is generated.

To avoid manually entering timing constraints in a UCF, use the Constraints Editor, which greatly simplifies creating constraints. For a detailed description of how to use the Constraints Editor, see the Constraints Editor Help included with the software.

- Enter the timing constraints in the Physical Constraints File (PCF), a file that is generated by MAP. The PCF file contains any timing constraints specified using the two previously described methods and any additional constraints you enter in the file. Modifying the PCF file is not generally recommended.

If no timing constraints are found for the design or the Project Navigator "Ignore User Timing Constraints" option is checked, timing constraints are automatically generated for all internal clocks. These constraints will be adjusted to get better performance as PAR runs. The level of performance achieved is in direct relation to the setting of the PAR effort level. Effort level STD will have the fastest run time and the lowest performance, effort level HIGH will have the best performance and the longest run time.

Timing-driven placement and timing-driven routing are automatically invoked if PAR finds timing constraints in the physical constraints file. The physical constraints file serves as input to the timing analysis software. For more information on constraints, see the [Constraints Guide \(UG625\)](#).

Note Depending upon the types of timing constraints specified and the values assigned to the constraints, PAR run time may be increased.

When PAR is complete, you can review the output PAR Report for a timing summary, or verify that timing characteristics for the design (relative to the physical constraints file) have been met by running the Timing Reporter And Circuit Evaluator (TRACE) or Timing Analyzer. TRACE, which is described in detail in the [TRACE](#) chapter of this guide, issues a report showing any timing warnings and errors and other information relevant to the design.

PAR Syntax

The following syntax places and routes your design:

```
par [options] infile [.ncd] outfile [pcf_file [.pcf]]
```

- *options* can be any number of the PAR options listed in [PAR Options](#). Enter options in any order, preceded them with a dash (minus sign on the keyboard) and separate them with spaces.
- *infile* is the design file you wish to place and route. The file must include a .ncd extension, but you do not have to specify the .ncd extension on the command line.
- *outfile* is the target design file that is written after PAR is finished. If the command options you specify yield a single output design file, *outfile* has an extension of .ncd. A .ncd extension generates an output file in NCD format. If the specified command options yield more than one output design file, *outfile* must have an extension. The multiple output files are placed in the directory with the default .ncd extension.

Note If the file or directory you specify already exists, an error messages appears and the operation is not run. You can override this protection and automatically overwrite existing files by using the **-w** option.

pcf_file is a Physical Constraints File (PCF). The file contains the constraints you entered during design entry, constraints you added using the User Constraints File (UCF) and constraints you added directly in the PCF file. If you do not enter the name of a PCF on the command line and the current directory contains an existing PCF with the *infile* name and a *.pcf* extension, PAR uses the existing PCF.

Example 1

```
par input.ncd output.ncd
```

This example places and routes the design in the file *input.ncd* and writes the placed and routed design to *output.ncd*.

Note PAR will automatically detect and include a PCF that has the same root name as the input NCD file.

Example 2

```
par -k previous.ncd reentrant.ncd pref.pcf
```

This example skips the placement phase and preserves all routing information without locking it (re-entrant routing). Then it runs in conformance to timing constraints found in the *pref.pcf* file. If the design is fully routed and your timing constraints are not met, then the router attempts to reroute until timing goals are achieved or until it determines it is not achievable.

Detailed Listing of Options

This section describes PAR options in more detail. The listing is in alphabetical order.

- [-activityfile \(Activity File\)](#)
- [-clock_regions \(Generate Clock Region Report\)](#)
- [-f \(Execute Commands File\)](#)
- [-intstyle \(Integration Style\)](#)
- [-filter \(Filter File\)](#)
- [-k \(Re-Entrant Routing\)](#)
- [-mt \(Multi-Threading\)](#)
- [-nopad \(No Pad\)](#)
- [-ntd \(Non Timing Driven\)](#)
- [-ol \(Overall Effort Level\)](#)
- [-p \(No Placement\)](#)
- [-pl \(Placer Effort Level\)](#)
- [-power \(Power Aware PAR\)](#)
- [-r \(No Routing\)](#)
- [-rl \(Router Effort Level\)](#)
- [-smartguide \(SmartGuide\)](#)
- [-t \(Starting Placer Cost Table\)](#)
- [-w \(Overwrite Existing Files\)](#)
- [-x \(Performance Evaluation Mode\)](#)
- [-xe \(Extra Effort Level\)](#)

-activityfile (Activity File)

This option lets you specify a switching activity data file to guide power optimizations.

Note This option requires the use of the **-power** option, and is available for all architectures except Spartan®-6, Virtex®-6, and 7 series.

Syntax

-activityfile *activityfile* *.{vcd|saif}*

PAR supports two activity file formats, *.saif* and *.vcd*.

-clock_regions (Generate Clock Region Report)

Use this option to specify whether or not to generate a clock region report when the PAR process is run.

Syntax

-clock_regions *generate_clock_region_report*

This report contains information on the resource utilization of each clock region and lists and clock conflicts between global clock buffers in a clock region.

-f (Execute Commands File)

This option executes the command line arguments in the specified *command_file*.

Syntax

-f *command_file*

For more information on the **-f** option, see [-f \(Execute Commands File\)](#) in the Introduction chapter.

-intstyle (Integration Style)

This option limits screen output, based on the integration style that you are running, to warning and error messages only.

Syntax

-intstyle *ise|xflow|silent*

When using **-intstyle**, one of three modes must be specified:

- **-intstyle ise** indicates the program is being run as part of an integrated design environment.
- **-intstyle xflow** indicates the program is being run as part of an integrated batch flow.
- **-intstyle silent** limits screen output to warning and error messages only.

Note **-intstyle** is automatically invoked when running in an integrated environment such as Project Navigator or XFLOW.

-filter (Filter File)

This option specifies a filter file, which contains settings to capture and filter messages produced by the program during execution.

Syntax

-filter [*filter_file*]

By default, the filter file name is `filter.filter`.

-k (Re-Entrant Routing)

This option runs re-entrant routing, starting with existing placement and routing. By default this option is off.

Syntax

```
-k previous_NCD.ncd reentrant.ncd
```

Routing begins with the existing placement and routing as a starting point; however, routing changes may occur and existing routing resources not kept.

Reentrant routing is useful to manually route parts of a design and then continue automatic routing; for example, to resume a prematurely halted route (Ctrl-C), or to run additional route passes.

-mt (Multi-Threading)

This option lets PAR use more than one processor. It provides multi-threading capabilities to the Placer.

Note This option is available for all devices except Spartan®-3, Spartan-3A, Spartan-3E, and Virtex®-4 devices. Multithreading is not available when you are using **-smartguide**, **-power on**, **-x**, partitions, or a project without a PCF file.

Syntax

```
-mt off | 2 | 3 | 4
```

The default is **off**. When **off**, the software uses only one processor. When the value is **2**, **3**, or **4** the software will use up to the number of cores specified.

-nopad (No Pad)

This option turns off creation of the three output formats for the PAD file report.

Syntax

```
-nopad
```

By default, all three PAD report types are created when PAR is run.

-ntd (Non Timing Driven)

This option tells PAR to perform non-timing driven placement.

Syntax

```
-ntd
```

When the **-ntd** switch is enabled, all timing constraints are ignored and the implementation tools do not use any timing information to place and route the design.

Note This option is available for both MAP and PAR, to run the entire flow without timing constraints set the **-ntd** switch for both MAP and PAR.

-ol (Overall Effort Level)

This option sets the overall PAR effort level.

Syntax

`-ol high|std`

- Use **high** for high effort level (best QOR with increased runtime)
- Use **std** for low effort level (fastest runtime at expense of QOR)

The default effort level is **std** for Spartan®-3, Spartan-3A, Spartan-3E, and Virtex®-4 devices, and **high** for all newer architectures.

The `-ol` option is available when running timing-driven packing and placement with the `-timing` option.

Note Xilinx® recommends setting the MAP effort level to equal or higher than the PAR effort level.

Example

```
par -ol std design.ncd output.ncd design.pcf
```

This example sets the overall PAR effort level to **std** (fastest runtime at expense of QOR).

-p (No Placement)

This option tells PAR to bypass the placer and proceed to the routing phase. A design must be fully placed when using this option or PAR will issue an error message and exit.

Syntax

`-p`

When you use this option, existing routes are ripped up before routing begins. To leave existing routing in place, use the `-k` (Re-Entrant Routing) option instead of `-p`.

Note Use this option to maintain a previous NCD placement but rerun the router.

Example

```
par -p design.ncd output.ncd design.pcf
```

This example tells PAR to skip placement and proceed directly to routing. If the design is not fully placed you will get an error message and PAR will do nothing.

-pl (Placer Effort Level)

This option sets the Placer effort level for PAR, overriding the overall effort level setting.

Note This option is available only for Spartan®-3, Spartan-3A, Spartan-3E, and Virtex®-4 devices. For other devices, use `-ol` (Overall Effort Level).

Syntax

`-pl high|std`

- Use **high** for the best placing results but longer run time. This setting is appropriate for more complex designs.
- Use **std** for a fast run time with lowest placing effort. This setting is appropriate for less complex designs.

The default effort level when you use `-pl` is **high**.

Example

```
par -pl high design.ncd output.ncd design.pcf
```

This example overrides the overall effort level set for PAR and sets the Placer effort level to **high**.

-power (Power Aware PAR)

This option tells PAR to optimize the capacitance of non-timing critical design signals.

Syntax

```
-power [on|off]
```

The default setting for this option is **off**. For devices other than Spartan®-6, Virtex®-6, and 7 series, when you use **-power on** you may also specify a switching activity file to guide power optimization. See the [-activityfile \(Activity File\)](#) option.

-r (No Routing)

This option tells PAR to skip routing the design after it has finished placement.

Syntax

```
-r
```

Note To skip placement on a design which is already fully placed, use the **-p** (No Placement) option.

Example

```
par -r design.ncd route.ncd design.pcf
```

This example causes the design to exit before the routing stage.

-rl (Router Effort Level)

This option sets the Router effort level for PAR, overriding the overall effort level setting.

Note This option is available only for Spartan®-3, Spartan-3A, Spartan-3E, and Virtex®-4 devices. For other devices, use **-o1** (Overall Effort Level).

Syntax

```
-rl high|std
```

- Use **high** for the best routing results but longer run time. This setting is appropriate for more complex designs.
- Use **std** for a fast run time with lowest routing effort. This setting is appropriate for less complex designs.

The default effort level when you use **-rl** is **high**.

Example

```
par -rl high design.ncd output.ncd design.pcf
```

This example overrides the overall effort level set for PAR and sets the Router effort level to **high**.

-smartguide (SmartGuide)

This option instructs the program to use results from a previous implementation to guide the current implementation, based on a placed and routed NCD file. SmartGuide™ technology automatically enables timing-driven packing and placement in MAP (**map -timing**), which improves design performance and timing for highly utilized designs.

You may obtain better results if you use the **map -timing** option to create a placed and routed NCD guide file before enabling SmartGuide technology. SmartGuide technology can be enabled from the command line or from the Hierarchy pane of the Design panel in Project Navigator.

Syntax

```
-smartguide design_name.ncd
```

With SmartGuide technology, all guiding is done in MAP at the BEL level. Guiding includes packing, placement, and routing. SmartGuide technology optimally changes the packing and placement of a design and then routes new nets during PAR. The first goal of SmartGuide technology is to maintain design implementation on the unchanged part and meet timing requirements on the changed part; the second goal is to reduce runtime. Notice that the unchanged part of the implementation will not be changed and therefore will keep the same timing score. Paths that fail timing but do not change should be 100% guided. Paths that fail timing and are changed will be re-implemented.

The results from the MAP run are stored in the output map report file (`.mrp`). Guide statistics, including the number of guided nets and all new, guided, and re-implemented components are listed in the map report, which is an estimated report. The final statistics are listed in the PAR report file (`.par`). A separate guide report file (`.grf`) is generated by PAR. If you use **-smartguide** in the PAR command line, a detailed guide report file is created. If you do not use **-smartguide**, a summary guide report file is created. The guide report file lists components and nets that are re-implemented or new. For more information and an example, see [Guide Report file \(GRF\)](#) in this chapter.

-t (Placer Cost Table)

This option specifies the cost table used by the placer.

Syntax

```
-t [placer_cost_table ]
```

placer_cost_table is the cost table used by the placer. Valid values are 1–100 and the default is 1.

To create implementations using several different cost tables, see the [SmartXplorer](#) chapter in this guide.

Note This option is available for Spartan®-3, Spartan-3A, Spartan-3E, and Virtex®-4 devices only. For other devices, to explore cost tables, use the MAP option **-t** (Starting Placer Cost Table) instead.

Example

```
par -t 10 -pl high -rl std design.ncd output_directory design.pcf
```

In this example, PAR uses cost table 10. The placer effort is at the highest and the router effort at std.

-w (Overwrite Existing Files)

This option instructs PAR to overwrite an existing NCD file.

Syntax

-w

By default (without this option), PAR will not overwrite an existing NCD file. If the specified NCD exists, PAR gives an error and terminates before running place and route.

-x (Performance Evaluation Mode)

This option tells PAR to ignore any timing constraints provided and generate new timing constraints on all internal clocks.

Syntax

-x

Use this option if there are timing constraints specified in the physical constraints file, and you want to execute a PAR run with tool-generated timing constraints instead of evaluating the performance of each clock in the design. This operation is referred to as Performance Evaluation Mode. This mode is entered into either by using the **-x** option or when no timing constraints are used in a design. The tool-generated timing constraints constrain each internal clock separately and tighten/loosen the constraints based on feedback during execution. The PAR effort level controls whether the focus is on fastest run time (STD) or best performance (HIGH).

PAR ignores all timing constraints in the `design.pcf`, and uses all physical constraints, such as LOC and AREA_RANGE.

-xe (Extra Effort Level)

Use this option to set the extra effort level.

Syntax

-xe n|c

n (normal) tells PAR to use additional runtime intensive methods in an attempt to meet difficult timing constraints. If PAR determines that the timing constraints cannot be met, then a message is issued explaining that the timing cannot be met and PAR exits.

c (continue) tells PAR to continue routing even if PAR determines the timing constraints cannot be met. PAR continues to attempt to route and improve timing until little or no timing improvement can be made.

Note Use of extra effort **c** can result in extremely long runtimes.

To use the **-xe** option, you must also set the **-ol** (Overall Effort Level) option to **high** or the **-pl** (Placer Effort Level) option and **-rl** (Router Effort Level) option be set to **high**.

Example

```
par -ol high -xe n design.ncd output.ncd design.pcf
```

This example directs PAR to use extra effort, but to exit if it determines that the timing constraints cannot be met.

PAR Reports

The output of PAR is a placed and routed NCD file (the output design file). In addition to the output design file, a PAR run generates a PAR report file with a `.par` extension. A Guide Report file (GRF) is created when you specify **-smartguide**.

The PAR report contains execution information about the place and route run as well as all constraint messages. For more information on PAR reports, see the [ReportGen Report](#) and [Guide Report file \(GRF\)](#) sections of this chapter.

If the options that you specify when running PAR are options that produce a single output design file, the output is the output design (NCD) file, a PAR file, and PAD files. A GRF is output when you specify `-smartguide`. The PAR, GRF, and PAD files have the same root name as the output design file.

Note The ReportGen utility can be used to generate pad report files (`.pad`, `pad.txt`, and `pad.csv`). The `pinout.pad` file is intended for parsing by user scripts. The `pad.txt` file is intended for user viewing in a text editor. The `pad.csv` file is intended for directed opening inside of a spreadsheet program. It is not intended for viewing through a text editor. See the [ReportGen](#) section of this chapter for information on generating and customizing pad reports.

Reports are formatted for viewing in a monospace (non-proportional) font. If the text editor you use for viewing the reports uses a proportional font, the columns in the report do not line up correctly. The `pad.csv` report is formatted for importing into a spreadsheet program or for parsing via a user script. In general, most reports generated by PAR in either separate files or within the `.par` file are also available in an XML data file called `<design name>_par.xrpt`.

Place and Route (PAR) Report

The Place and Route (PAR) report file is an ASCII text file that contains information about the PAR run. The report information varies based on the device and the options that you specify. The PAR report contains execution information about the PAR run and shows the processes run as PAR converges on a placement and routing solution for the design.

PAR Report Layout

The PAR report is divided into a number of ordered sections:

- **Design Information** - Shows the PAR command line, the device to which the design has been placed and routed, information on the input design files (NCD and PCF), and when placement and routing were performed. Warning and information messages may also appear in this first section of the PAR report.
- **Design Summary** - Provides a breakdown of the resources in the design and includes the Device Utilization Summary.
- **Placer Results** - Lists the different phases of the placer and identifies which phase is being executed. The checksum number shown is for Xilinx debugging purposes only and does not reflect the quality of the placer run.

Note When running `map -timing` and the SmartGuide™ tool, placer results do not appear in the PAR report file. Placement for these flows is done in MAP.

- **Router Results** - Lists each phase of the router and reports the number of unrouted nets, in addition to an approximate timing score that appears in parenthesis.
- **SmartGuide Report** - Describes the guide results after the router is invoked. This section of the PAR report accurately reflects the differences between the input design and the guide design, including the number of guided, re-implemented, and new or changed components.
- **Partition Implementation Status** - Lists which partitions were preserved and which partitions were re-implemented and the reasons why they were re-implemented. If no partitions are found in the design, the PAR report states this.
- **Clock Report** - Lists, in a table format, all of the clocks in the design and provides information on the routing resources, number of fanout, maximum net skew for each clock, and the maximum delay. The locked column in the clock table indicates whether the clock driver (BUFGMUX) is assigned to a particular site or left floating.

Note The clock skew and delay listed in the clock table differ from the skew and delay reported in TRACE and Timing Analyzer. PAR takes into account the net that drives the clock pins whereas TRACE and Timing Analyzer include the entire clock path.

- **Timing Score** - Lists information on timing constraints contained in the input PCF, including how many timing constraints were met. The first line of this section shows the Timing Score. In cases where a timing constraint is not met, the Timing Score will be greater than 0. Generally, the lower the Timing Score, the better the result.

Note The constraints table in this section of the PAR report is not generated when no constraints are given in the input PCF or the `-x` option is used.

- **Summary** - Lists whether PAR was able to place and route the design successfully. This section also lists the total time used to complete the PAR run in both REAL time and CPU time. A summary of the number of error, warning, and informational messages found during the PAR invocation are listed in this last section of the PAR report.

Sample PAR Report

This section shows an abbreviated PAR report. Most PAR report files are considerably larger than the example shown. In this example, the design is run with `-smartguide`. Note that the Placer section of the PAR report is not present, since with the SmartGuide tool, placement is done in MAP. Some lines have been removed to save space.

```
par -w -intstyle ise -ol high -mt off wave_gen_map.ncd wave_gen.ncd
wave_gen.pcf
```

```
Constraints file: wave_gen.pcf.
```

```
Loading device for application Rf_Device from file '7k70t.nph' in environment C:\Xilinx\13.1\ISE_DS\ISE\.
```

"wave_gen" is an NCD, version 3.2, device xc7k70t, package fbg484, speed -1

 Initializing temperature to 85.000 Celsius. (default - Range: 0.000 to 85.000 Celsius)
 Initializing voltage to 0.950 Volts. (default - Range: 0.950 to 1.050 Volts)

Device speed data version: "ADVANCED 1.00 2011-02-03".

Device Utilization Summary:

Slice Logic Utilization:

Number of Slice Registers:	593 out of 84,400	1%
Number used as Flip Flops:	593	
Number used as Latches:	0	
Number used as Latch-thrus:	0	
Number used as AND/OR logics:	0	
Number of Slice LUTs:	934 out of 42,200	2%
Number used as logic:	880 out of 42,200	2%
Number using O6 output only:	632	
Number using O5 output only:	15	
Number using O5 and O6:	233	
Number used as ROM:	0	
Number used as Memory:	0 out of 13,400	0%
Number used exclusively as route-thrus:	54	
Number with same-slice register load:	53	
Number with same-slice carry load:	1	
Number with other load:	0	

Slice Logic Distribution:

Number of occupied Slices:	309 out of 10,550	2%
Number of LUT Flip Flop pairs used:	1,039	
Number with an unused Flip Flop:	570 out of 1,039	54%
Number with an unused LUT:	105 out of 1,039	10%
Number of fully used LUT-FF pairs:	364 out of 1,039	35%
Number of slice register sites lost to control set restrictions:	0 out of 84,400	0%

A LUT Flip Flop pair for this architecture represents one LUT paired with one Flip Flop within a slice. A control set is a unique combination of clock, reset, set, and enable signals for a registered element.

The Slice Logic Distribution report is not meaningful if the design is over-mapped for a non-slice resource or if Placement fails.

OVERMAPPING of BRAM resources should be ignored if the design is over-mapped for a non-BRAM resource or if placement fails.

IO Utilization:

Number of bonded IOBs:	17 out of 285	5%
------------------------	---------------	----

Specific Feature Utilization:

Number of RAMB36E1/FIFO36E1s:	0 out of 135	0%
Number of RAMB18E1/FIFO18E1s:	2 out of 270	1%
Number using RAMB18E1 only:	2	
Number using FIFO18E1 only:	0	
Number of BUFG/BUFGCTRLs:	3 out of 32	9%
Number used as BUFGBs:	3	
Number used as BUFGCTRLs:	0	
Number of ILOGICE2/ILOGICE3/ISERDESE2s:	0 out of 300	0%
Number of OLOGICE2/OLOGICE3/OSERDESE2s:	11 out of 300	3%
Number used as OLOGICE2s:	11	
Number used as OLOGICE3s:	0	
Number used as OSERDESE2s:	0	
Number of PHASER_IN/PHASER_IN_PHYS:	0 out of 24	0%
Number of PHASER_OUT/PHASER_OUT_PHYS:	0 out of 24	0%
Number of BSCANS:	0 out of 4	0%
Number of BUFHCEs:	1 out of 96	1%
Number of BUFBRs:	0 out of 24	0%
Number of CAPTUREs:	0 out of 1	0%
Number of DSP48E1s:	0 out of 240	0%
Number of EFUSE_USRs:	0 out of 1	0%

```

Number of GTXE2_CHANNELS:          0 out of      8    0%
Number of GTXE2_COMMONS:          0 out of      2    0%
Number of ICAPS:                  0 out of      2    0%
Number of IDELAYCTRLs:            0 out of      6    0%
Number of IN_FIFOs:               0 out of     24    0%
Number of MMCME2_ADVs:            1 out of      6   16%
Number of OUT_FIFOs:              0 out of     24    0%
Number of PCIE_2_1s:              0 out of      1    0%
Number of PHASER_REFS:            0 out of      6    0%
Number of PHY_CONTROLS:           0 out of      6    0%
Number of PLLE2_ADVs:             0 out of      6    0%
Number of STARTUPS:               0 out of      1    0%

```

```

Overall effort level (-ol):  High
Router effort level (-rl):   High

```

```

INFO:Timing:3386 - Intersecting Constraints found and resolved. For more information, see the TSI report.
Please consult the Xilinx Command Line Tools User Guide for information on generating a TSI report.
Starting initial Timing Analysis.  REAL time: 16 secs
Finished initial Timing Analysis.  REAL time: 16 secs

```

Starting Router

```

Phase 1 : 5260 unrouted;      REAL time: 18 secs
Phase 2 : 4673 unrouted;      REAL time: 19 secs
Phase 3 : 1910 unrouted;      REAL time: 21 secs
Phase 4 : 1910 unrouted; (Setup:0, Hold:9430, Component Switching Limit:0)  REAL time: 26 secs

```

Updating file: wave_gen.ncd with current fully routed design.

```

Phase 5 : 0 unrouted; (Setup:0, Hold:8243, Component Switching Limit:0)  REAL time: 28 secs
Phase 6 : 0 unrouted; (Setup:0, Hold:8243, Component Switching Limit:0)  REAL time: 28 secs
Phase 7 : 0 unrouted; (Setup:0, Hold:8243, Component Switching Limit:0)  REAL time: 28 secs
Phase 8 : 0 unrouted; (Setup:0, Hold:8243, Component Switching Limit:0)  REAL time: 28 secs
Phase 9 : 0 unrouted; (Setup:0, Hold:0, Component Switching Limit:0)  REAL time: 29 secs
Total REAL time to Router completion: 29 secs
Total CPU time to Router completion: 28 secs

```

Partition Implementation Status

```

-----
No Partitions were found in this design.
-----

```

Generating "PAR" statistics.

```

*****
Generating Clock Report
*****

```

Clock Net	Resource	Locked	Fanout	Net Skew(ns)	Max Delay(ns)
clk_rx	BUFGCTRL_X0Y1	No	104	0.086	1.796
clk_tx	BUFGCTRL_X0Y2	No	68	1.222	1.983
clk_gen_i0/clk_core_i0/clkfbout_buf	BUFGCTRL_X0Y0	No	1	0.000	1.611
clk_samp	Local		22	0.273	1.133
clk_gen_i0/clk_core_					

```

|          i0/clkin1 |          Local |          |          1 |          0.000 |          0.845 |
+-----+-----+-----+-----+-----+-----+

```

* Net Skew is the difference between the minimum and maximum routing only delays for the net. Note this is different from Clock Skew which is reported in TRCE timing report. Clock Skew is the difference between the minimum and maximum path delays which includes logic delays.

Timing Score: 0 (Setup: 0, Hold: 0, Component Switching Limit: 0)

Number of Timing Constraints that were not applied: 1

Asterisk (*) preceding a constraint indicates it was not met.
This may be due to a setup or hold violation.

Constraint	Check	Worst Case Slack	Best Case Achievable	Timing Errors	Timing Score
OFFSET = IN 5 ns VALID 8 ns BEFORE COMP "clk_pin" "RISING"	SETUP HOLD	0.760ns 4.034ns	4.240ns	0 0	0 0
NET "uart_rx_i0/meta_harden_rxd_i0/signal_meta" MAXDELAY = 2 ns	MAXDELAY	1.597ns	0.403ns	0	0
NET "lb_ctl_i0/debouncer_i0/meta_harden_signal_in_i0/signal_meta" MAXDELAY = 2 ns	MAXDELAY	1.624ns	0.376ns	0	0
NET "clkx_nsamp_i0/meta_harden_bus_new_i0/signal_meta" MAXDELAY = 2 ns	MAXDELAY	1.633ns	0.367ns	0	0
NET "clkx_spd_i0/meta_harden_bus_new_i0/signal_meta" MAXDELAY = 2 ns	MAXDELAY	1.636ns	0.364ns	0	0
NET "clkx_pre_i0/meta_harden_bus_new_i0/signal_meta" MAXDELAY = 2 ns	MAXDELAY	1.636ns	0.364ns	0	0
NET "samp_gen_i0/meta_harden_samp_gen_i0/signal_meta" MAXDELAY = 2 ns	MAXDELAY	1.748ns	0.252ns	0	0
TS_clk_gen_i0_clk_core_i0_clkout1 = PERIOD TIMEGRP "clk_gen_i0_clk_core_i0_clkout1" TS_clk_pin / 0.96875 HIGH 50%	SETUP HOLD	2.445ns 0.064ns	5.432ns	0 0	0 0
OFFSET = OUT 8 ns AFTER COMP "clk_pin"	MAXDELAY	2.927ns	5.073ns	0	0
TS_clk_rx_to_clk_tx = MAXDELAY FROM TIMEGRP "TNM_clk_rx" TO TIMEGRP "TNM_clk_tx" 5 ns DATAPATHONLY	SETUP HOLD	3.571ns 0.117ns	1.429ns	0 0	0 0
TS_clk_tx_to_clk_rx = MAXDELAY FROM TIMEGRP "TNM_clk_tx" TO TIMEGRP "TNM_clk_rx" 5 ns DATAPATHONLY	SETUP HOLD	3.972ns 0.136ns	1.028ns	0 0	0 0
TS_clk_gen_i0_clk_core_i0_clkout0 = PERIOD TIMEGRP "clk_gen_i0_clk_core_i0_clkout0" TS_clk_pin HIGH 50%	SETUP HOLD	4.626ns 0.056ns	5.374ns	0 0	0 0
COMP "spi_clk_pin" OFFSET = OUT 8 ns AFTER COMP "clk_pin" "RISING"	MAXDELAY	5.067ns	2.933ns	0	0
COMP "spi_clk_pin" OFFSET = OUT 8 ns AFTER COMP "clk_pin" "FALLING"	MAXDELAY	5.067ns	2.933ns	0	0
TS_clk_pin = PERIOD TIMEGRP "clk_pin" 10 ns HIGH 50%	MINLOWPULSE	6.000ns	4.000ns	0	0
TS_to_bcd = MAXDELAY FROM TIMEGRP "TNM_sense_resp_data" TO TIMEGRP "TNM_to_bcd_flops" TS_clk_gen_i0_clk_core_i0_clkout0 * 2	SETUP HOLD	7.265ns 0.236ns	12.735ns	0 0	0 0

TS_clk_samp = MAXDELAY FROM TIMEGRP "TNM_	SETUP	325.155ns	5.167ns	0	0
clk_samp" TO TIMEGRP "TNM_clk_samp"	HOLD	0.174ns		0	0
TS_clk_gen_i0_clk_core_i0_clkout1 * 32					

TS_uart_rx_ctl = MAXDELAY FROM TIMEGRP "T	SETUP	536.895ns	3.105ns	0	0
NM_uart_rx_ctl" TO TIMEGRP "TNM_u	HOLD	0.127ns		0	0
art_rx_ctl" TS_clk_gen_i0_clk_core_i0_clk					
out0 * 54					

TS_uart_tx_ctl = MAXDELAY FROM TIMEGRP "T	SETUP	554.525ns	2.894ns	0	0
NM_uart_tx_ctl" TO TIMEGRP "TNM_u	HOLD	0.151ns		0	0
art_tx_ctl" TS_clk_gen_i0_clk_core_i0_clk					
out1 * 54					

Derived Constraint Report

Review Timing Report for more details on the following derived constraints.

To create a Timing Report, run "trce -v l2 -fastpaths -o design_timing_report design.ncd design.pcf" or "Run Timing Analysis" from Timing Analyzer (timingan).

Derived Constraints for TS_clk_pin

Constraint	Period Requirement	Actual Period		Timing Errors		Paths Analyzed	
		Direct	Derivative	Direct	Derivative	Direct	Derivative
TS_clk_pin	10.000ns	4.000ns	6.367ns	0	0	0	117601200
TS_clk_gen_i0_clk_core_i0_clko	10.000ns	5.374ns	6.367ns	0	0	7169	117587196
ut0							
TS_to_bcd	20.000ns	12.735ns	N/A	0	0	117587002	0
TS_uart_rx_ctl	540.000ns	3.105ns	N/A	0	0	194	0
TS_clk_gen_i0_clk_core_i0_clko	10.323ns	5.432ns	0.161ns	0	0	4349	2486
ut1							
TS_uart_tx_ctl	557.419ns	2.894ns	N/A	0	0	108	0
TS_clk_samp	330.323ns	5.167ns	N/A	0	0	2378	0

All constraints were met.

Generating Pad Report.

All signals are completely routed.

Total REAL time to PAR completion: 32 secs

Total CPU time to PAR completion: 30 secs

Peak Memory Usage: 398 MB

Placer: Placement generated during map.

Routing: Completed - No errors found.

Timing: Completed - No errors found.

Number of error messages: 0

Number of warning messages: 1

Number of info messages: 1

Writing design to file wave_gen.ncd

PAR done!

Guide Report file (GRF)

The Guide Report file (GRF) is an ASCII text file that shows the actual components and nets that were guided. The GRF has the same summary as the PAR report and also lists all of the components and nets that were not guided. If a component or net is not in the GRF, then it was guided. Guided components and nets are not listed in order to reduce the size of the file.

Guide Report Layout

The Guide Report file (GRF) is divided into a number of sections, including a section showing the results from using the SmartGuide™ tool.

The SmartGuide Results section is a summary of the guide results after the router is invoked, and lists the differences between the input design and the guide design by summarizing the following:

- Number of Guided Components—A guided component has the same name in both the input design and the guide design, and is in the same site in both designs. It may have different LUT equations, pins, etc.
- Number of Re-implemented Components—A re-implemented component's name is the same in both the input design and the guide design. Either the component was not placed in the guide file or the component has been moved in order to meet the overall timing of the design.
- Number of New/Changed Components—A new/changed component is one whose name could not be found in the guide design, but exists in the input design. The design source may have changed or synthesis may have changed the name.
- Number of Guided Nets—A guided net is one whose source pin is the same in both the input design and guide design, load pin(s) are the same in both design files, and it has the exact same routing physically on the device.
- Number of partially guided Nets—A partially guided net is one that is in both the input design and the guide design but some of the route segments are different.
- Number of Re-routed Nets—A re-routed net is one that is in both the input design and the guide design but all of the route segments are different. It has been re-routed in order to meet the overall timing of the design.

Note SmartGuide does not use net names for guiding, so a change in the net name will not change the guiding. SmartGuide looks at the source and load pins of a net to determine if it can be guided.

- Number of New/Changed Nets—A new/changed net is one that is only found in the input design. The design source may have changed or synthesis may have changed the connections of the net.

In addition to the SmartGuide Results, the GRF gives a detailed list of the following:

- Components that were re-implemented
- Components that are new/changed
- Networks that were re-implemented
- Networks that are new/changed

Sample Guide Report File

This section shows an abbreviated GRF. A GRF file will usually be larger than the example shown.

SmartGuide Results

This section describes the guide results after invoking the Router.
This report accurately reflects the differences between the input design and the guide design.

Number of Components in the input design		99		
Number of guided Components		99 out of	99	100.0%
Number of re-implemented Components		0 out of	99	0.0%
Number of new/changed Components		0 out of	99	0.0%
Number of Nets in the input design		67		
Number of guided Nets		65 out of	67	97.0%
Number of re-routed Nets		2 out of	67	3.0%
Number of new/changed Nets		0 out of	67	0.0%

The following Components were re-implemented.

The following Components are new/changed.

The following Nets were re-routed.

GLOBAL_LOGIC0.
GLOBAL_LOGIC1.

The following Nets are new/changed.

ReportGen

This utility generates reports that are specified on the command line using one or more of the ReportGen options. ReportGen takes a Native Circuit Description (NCD) file as input and outputs various pad reports and a log file that contains standard copyright and usage information on any reports being generated.

Note Some reports require placed and routed NCD files as input.

ReportGen Syntax

The following syntax runs the ReportGen utility:

```
reportgen [options] infile [.ncd]
```

- *options* can be any number of the ReportGen options listed in the ReportGen Options section of this chapter. Enter options in any order, preceded them with a dash (minus sign on the keyboard) and separate them with spaces.
- *infile* is the design file you wish to place and route. The file must include a .ncd extension, but you do not need to specify the extension.

ReportGen Input Files

Input to ReportGen consists of the following files:

NCD file - a mapped design for FPGA architectures.

ReportGen Output Files

Output from ReportGen consists of the following report files:

- **DLY file** - a file containing delay information on each net of a design.
- **PAD file** - a file containing I/O pin assignments in a parsable database format.
- **CSV file** - a file containing I/O pin assignments in a format directly supported by spreadsheet programs.
- **TXT file** - a file containing I/O pin assignments in a ASCII text version for viewing in a text editor.
- **CLK_RGN file** - a file containing information about the global clock region usage for a design. Only available for Virtex®-4 and Virtex-5 architectures.

Files output by ReportGen are placed in the current working directory or the path that is specified on the command line with the `-o` option. The output pad files have the same root name as the output design file, but the `.txt` and `.csv` files have the tag `pad` added to the output design name. For example, `output_pad.txt`.

ReportGen Options

You can customize ReportGen output by specifying options when you run ReportGen from the command line. You must specify the reports you wish to generate.

The PAD report columns show the type of DCI termination being used such as `SPLIT` and `NONE`.

The following table lists available ReportGen options and includes a functional description and a usage example for each option:

Option	Function	Usage
<code>-clock_regions</code>	Generates a clock region report.	<code>reportgen -clock_regions</code>
<code>-delay</code>	Generates a delay report.	<code>reportgen -delay</code>
<code>-f</code>	Reads ReportGen command line arguments and switches specified in a command file.	<code>reportgen -f cmdfile.cmd</code>
<code>-h</code>	Displays ReportGen usage information and help contents.	<code>reportgen -h</code>
<code>-intstyle</code>	Reduces screen output to error and warning messages based on the integration style you are running.	<code>reportgen -intstyle {ise xflow silent}</code>
<code>-o</code>	Specifies the report output directory and filename.	<code>reportgen -o</code>
<code>-pad</code>	Generates a pad report file. You can modify this command by using <code>-padfmt</code> and/or <code>-padsortcol</code> .	<code>reportgen design.ncd -pad</code>
<code>-padfmt</code> all csv pad text	Specifies the format in which to generate a pad report. You must also specify <code>-pad</code> when using this option.	<code>reportgen design.ncd -pad -padfmt all csv pad text</code>
<code>-padsortcol</code>	Specifies the columns to display in a pad report, and the sorting order. You must also specify <code>-pad</code> when using this option. Default: No sorting and all columns are displayed.	<code>reportgen design.ncd -pad -padfmt csv -padsortcol 1, 3:5, 8</code> Use commas to separate values and ranges. For example, specifying 1, 3:5, 8 generates a pad report sorted on column 1 and displaying columns 1, 3, 4, 5, and 8.
<code>-unrouted_nets</code>	Generates an unrouted networks report.	<code>reportgen -unrouted_nets</code>

Halting PAR

You cannot halt PAR with **Ctrl-C** if you do not have **Ctrl-C** set as the interrupt character. You need to set the interrupt character by entering **stty intr ^C** in the `.login` file or `.cshrc` file.

To halt a PAR operation, enter **Ctrl-C**. In a few seconds, the following message appears:

```
Ctrl-C interrupt detected.
STATUS:
+-----+
| Most recent SmartPreview on disk: | xxx.ncd |
| Fully placed: | YES |
| Fully routed: | YES |
| SmartPreview status: | ready for bitgen |
| Timing score: | 988 |
| Timing errors: | 25 |
| Number of failing constraints: | 1 |
+-----+
Option 3 in the menu below will save the SmartPreview design file and a timing summary in ./SmartPreview.

MENU: Please choose one of the following options:
1. Ignore interrupt and continue processing.
2. Exit program immediately.
3. Preserve most recent SmartPreview and continue (see STATUS above).
4. Cancel current 'par' job at next check point.
```

Note If you started the PAR operation as a background process on a workstation, you must bring the process to the foreground using the **-fg** command before you can halt the PAR operation.

After you run PAR, you can use FPGA Editor on the NCD file to examine and edit the results. You can also perform a static timing analysis using TRACE or Timing Analyzer. When the design is routed to your satisfaction, you can use the resulting file as input to BitGen, which creates the files used for downloading the design configuration to the target FPGA. For details on BitGen, see the [BitGen](#) chapter in this guide.

SmartXplorer

SmartXplorer automatically performs design exploration by using a set of built-in or custom implementation and/or synthesis strategies to try to meet timing for your design.

SmartXplorer Overview

Timing closure is one of the most challenging aspects in modern FPGA design. Xilinx® solutions can help you overcome such timing challenges by:

- Improving synthesis and implementation algorithms
- Providing graphical analysis tools such as PlanAhead™ and FPGA Editor

Although FPGA tools have become easier to use while offering more and more advanced features it is difficult to anticipate all design situations. Some of them may stay hidden until the very last stages of a design cycle, appearing just before delivering the product.

Delivering Timing Closure in the shortest amount of time is the ultimate SmartXplorer goal.

Key Benefits

SmartXplorer has two key features:

- It automatically performs design exploration by [using a set of built-in or custom implementation strategies](#) to try to meet timing.

Note A design strategy is a set of tool options and their corresponding values that are intended to achieve a particular design goal such as area, speed, or power.

- It lets you [run these strategies in parallel](#) on multiple machines, completing the job much faster.

Device Support

This program is compatible with the following device families:

- 7 series
- Spartan®-3, Spartan-3A, Spartan-3E, and Spartan-6
- Virtex®-4, Virtex-5, and Virtex-6

Using SmartXplorer Strategies

SmartXplorer is a tool for managing the exploration of multiple design implementation strategies while leveraging the power of parallel processing using multiple work station servers on your network. These servers can either be managed individually or by interfacing to a grid system (AKA compute farm). LSF (Load Sharing Facility) or SGE (Sun Grid Engine) are the grid systems supported by SmartXplorer. Understanding the need of strategies and variability in tool results will let you use SmartXplorer efficiently and reach timing closure more quickly.

This chapter shows how to use SmartXplorer on a compute farm, and provides various use case models with examples of the commands for these use cases. Some of these examples include the use of LSF or SGE grid systems. This chapter also provides information for examining SmartXplorer failures, including the use of debug log files.

Running Implementation Strategies Only

To skip the synthesis step and run implementation strategies only, specify the synthesized netlist (NGC or EDIF) in the SmartXplorer command line. For instance:

On Linux -

```
smartxplorer -p xc6slx16-2-csg324 -uc stopwatch.ucf -sd ".;ipcore_dir" stopwatch.ngc
```

On Windows -

```
smartxplorer.exe -p xc6slx16-2-csg324 -uc stopwatch.ucf -sd ".;ipcore_dir" stopwatch.ngc
```

Using the Built-In Strategies

SmartXplorer provides several built-in synthesis strategies. For example, it provides 7 XST and 5 Synplify strategies for Spartan®-6 devices. In default mode, all of these strategies will be run in order to identify the best netlist from a performance point of view. As soon as the best netlist is identified, SmartXplorer will run it through the built-in implementation strategies to obtain the best timing score. You can use the **-la** option to obtain a list of the predefined strategies.

Note SmartXplorer lets you create your own custom synthesis and/or implementation strategies. See [Custom Strategies](#) for more information.

Example

For Spartan-6 devices, SmartXplorer provides 7 XST and 7 implementation strategies. Since one of the predefined implementation strategies will be used as the Quick Implementation strategy for synthesis runs, SmartXplorer will run 13 strategies in default mode to obtain the best timing score. To run predefined strategies you can use the following command:

On Linux -

```
smartxplorer -p xc6slx16-2-csg324 -uc stopwatch.ucf -wd res_dir -sd ".;ipcore_dir" stopwatch.xst
```

On Windows -

```
smartxplorer.exe -p xc6slx16-2-csg324 -uc stopwatch.ucf -wd res_dir -sd ".;ipcore_dir" stopwatch.xst
```

Once running, SmartXplorer creates a status table to display progress and the final results summary. Each row in this table represents one of the predefined SmartXplorer strategies. This can be seen:

- In the Terminal Window.
- In the `smartxplorer.html` file, located in the directory where SmartXplorer was launched (unless the `-wd` option is used). You should use a Web browser to open this file. See the [SmartXplorer Reports](#) section for more information on reports.

These tables are progressively updated during the SmartXplorer run. Following is an example of an intermediate state (`smartxplorer.html`):

Strategy	Host	Output	Status	Timing Score	Total Run Time
XSTOptReshRedcon_MapRunTime	host_1	run1	None	None	None
XSTOptOnehot_MapRunTime	None	None	None	None	None
XSTOnehot_MapRunTime	None	None	None	None	None
XSTOptOnehotRedcon_MapRunTime	None	None	None	None	None
XSTRegbalOptOnehot_MapRunTime	None	None	None	None	None
XSTOnehotRedcon_MapRunTime	None	None	None	None	None
XSTRegbalOptOnehotReshRedcon_MapRunTime	None	None	None	None	None

During the synthesis phase, SmartXplorer shows all synthesis strategies with the Quick Implementation strategy which is used to obtain the timing score.

Note The strategy in the left column represents the combination of synthesis and Quick Implementation strategy separated by an underscore (“_”). For example XSTOptReshRedcon_MapRunTime means that the name of the synthesis strategy is XSTOptReshRedcon and the name of the Quick Implementation strategy is MapRunTime.

As soon as all synthesis strategies are completed, SmartXplorer selects the best netlist based on timing score and runs it using different implementation strategies updating the HTML report:

Strategy	Host	Output	Status	Timing Score	Total Run Time
XSTOptReshRedcon_MapRunTime	host_1	run1	Done	11340	0h 3m 4s
XSTOptOnehot_MapRunTime	host_1	run2	Done	12893	0h 7m 54s
XSTOnehot_MapRunTime	host_1	run3	Done	12893	0h 3m 24s
XSTOptOnehotRedcon_MapRunTime	host_1	run4	Done	12893	0h 1m 29s
XSTRegbalOptOnehot_MapRunTime	host_1	run5	Done	8907	0h 1m 30s
XSTOnehotRedcon_MapRunTime	host_1	run6	Done	12893	0h 1m 19s
XSTRegbalOptOnehotReshRedcon_MapRunTime	host_1	run7	Done	8907	0h 1m 25s
XSTRegbalOptOnehotReshRedcon_MapGlobOptLogOptRegDup	host_1	run8	Mapping	None	0h 0m 28s
XSTRegbalOptOnehotReshRedcon_MapGlobOptIOReg	None	None	None	None	None
XSTRegbalOptOnehotReshRedcon_MapRegDup	None	None	None	None	None
XSTRegbalOptOnehotReshRedcon_MapExtraEffortIOReg	None	None	None	None	None
XSTRegbalOptOnehotReshRedcon_MapLogOptRegDup	None	None	None	None	None
XSTRegbalOptOnehotReshRedcon_MapExtraEffort2	None	None	None	None	None

In this example, the XSTRegbalOptOnehotReshRedcon synthesis strategy (run7) was selected as the best after 7 runs as it has the smallest timing score and runtime (the XSTRegbalOptOnehot has the same timing score, but requires longer runtime). This strategy is used to run 6 implementation strategies (run8 to run13). After all runs are completed the best strategy is highlighted using green (run8) :

Strategy	Host	Output	Status	Timing Score	Total Run Time
XSTOptReshRedcon_MapRunTime	host_1	run1	Done	11340	0h 3m 4s
XSTOptOnehot_MapRunTime	host_1	run2	Done	12893	0h 7m 54s
XSTOnehot_MapRunTime	host_1	run3	Done	12893	0h 3m 24s
XSTOptOnehotRedcon_MapRunTime	host_1	run4	Done	12893	0h 1m 29s
XSTRegbalOptOnehot_MapRunTime	host_1	run5	Done	8907	0h 1m 30s
XSTOnehotRedcon_MapRunTime	host_1	run6	Done	12893	0h 1m 19s
XSTRegbalOptOnehotReshRedcon_MapRunTime	host_1	run7	Done	8907	0h 1m 25s
XSTRegbalOptOnehotReshRedcon_MapGlobOptLogOptRegDup	host_1	run8	Done	7756	0h 1m 9s
XSTRegbalOptOnehotReshRedcon_MapGlobOptIOReg	host_1	run9	Done	7756	0h 1m 29s
XSTRegbalOptOnehotReshRedcon_MapRegDup	host_1	run10	Done	8907	0h 1m 9s
XSTRegbalOptOnehotReshRedcon_MapExtraEffortIOReg	host_1	run11	Done	10967	0h 1m 5s
XSTRegbalOptOnehotReshRedcon_MapLogOptRegDup	host_1	run12	Done	10076	0h 1m 14s
XSTRegbalOptOnehotReshRedcon_MapExtraEffort2	host_1	run13	Done	9714	0h 1m 15s

Note For more information on the best strategy selection algorithms in SmartXplorer, see [Selecting the Best Strategy](#).

The Run Summary table contains several links:

- The link in the Timing Score column provides you with the timing report summary for the corresponding strategy.

Asterisk (*) preceding a constraint indicates it was not met.
This may be due to a setup or hold violation.

Constraint	Check	Worst Case Slack	Best Case Achievable	Timing Errors	Timing Score
TS_inst_dcm1_CLK0_BUF = PERIOD TIMEGRP "inst_dcm1_CLK0_BUF" TS_CLK HIGH 50%	SETUP	-0.155	4.355	3	191
	HOLD	1.310		0	0
TS_CLK = PERIOD TIMEGRP "CLK" 4.2 ns HIGH 50%	MINPERIOD	0.034	4.166	0	0

- The link in the Output column opens a combined log file (synthesis, MAP, PAR, etc.) for the corresponding strategy: stopwatch_sx.log.

Results Directory Structure

Results for each SmartXplorer strategy are stored in separate directories (run1, run2, run3, ...), all of which are located in the directory where SmartXplorer is launched (unless the result directory is redefined via the `-wd` option). In the following example SmartXplorer was launched from a directory named "smartxplorer_results."

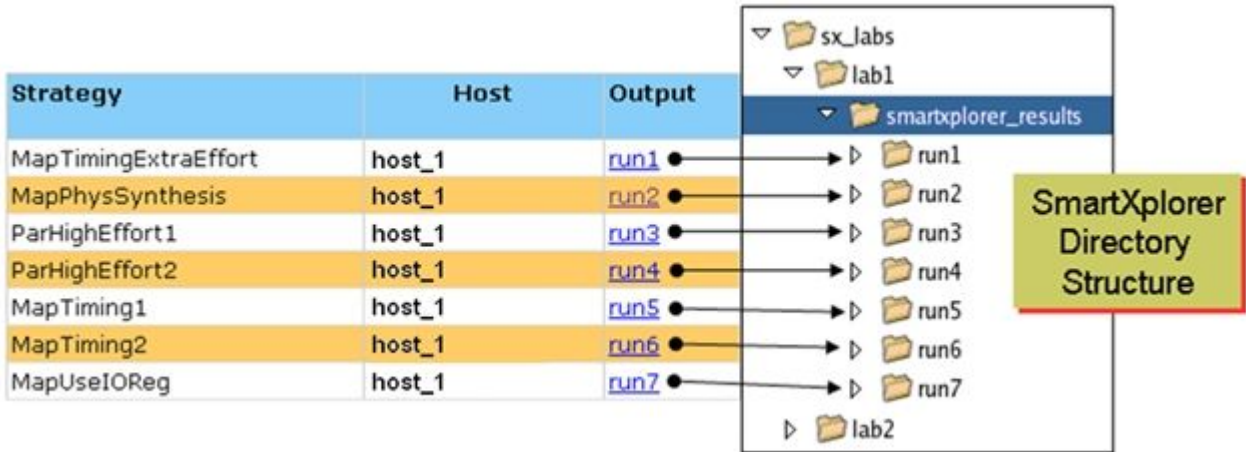

Controlling the number of executed strategies

You can change the total number of strategies using the `-m integer` option.

- If *integer* is 13, SmartXplorer runs in default mode.
- If *integer* is 8, SmartXplorer runs 7 synthesis strategies with Quick Implementation and one implementation strategy for the best netlist.
- If *integer* is 3, SmartXplorer runs 3 synthesis strategies with Quick Implementation.
- If *integer* is greater than 13, SmartXplorer runs all built-in synthesis and implementation strategies, and then selects the best implementation strategy with the smallest timing score and performs additional implementation runs using different cost tables. For instance, if you specify `-m 15`, SmartXplorer run 7 synthesis with Quick Implementation strategies, 6 built-in implementation strategies, and 2 additional implementation runs using the best strategy and using Cost tables 2 and 3.

Selecting the Best Strategy

Since delivering timing closure in the shortest amount of time is the ultimate SmartXplorer goal, the timing score and total runtime required to complete a strategy are the two primary criteria used to identify the best strategy. The following diagram illustrates the process of identifying the best strategy based on timing score and total runtime for two strategies (S1 and S2):

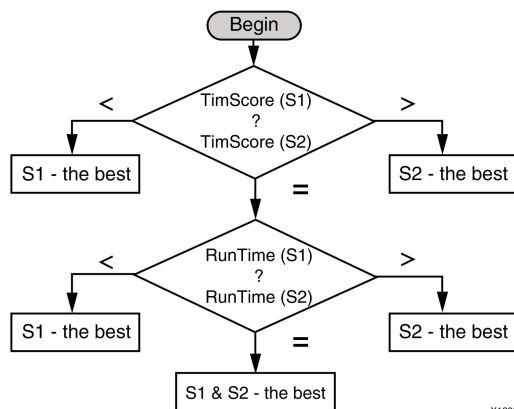

X12088

Starting with 12.1 software, you can use the `-pwo` option to run XPower Analyzer and calculate the total power dissipated by the design. If you enable power analysis, power data will be taken into account for selecting the best strategy. The following diagram illustrates the best strategy selection algorithm:

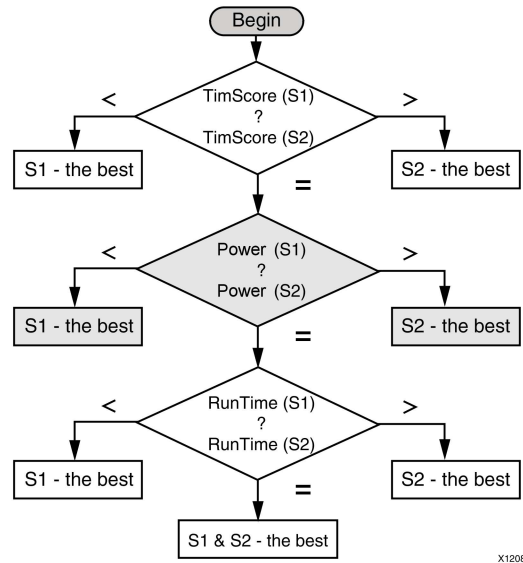

Another important criterion for best strategy selection is the area occupied by the implemented design. Currently SmartXplorer does not take into account area information in the best strategy identification. However, it helps you to make this choice by displaying area information in the Run Summary table:

Run Summary

Strategy	Host	Output	Status	Timing Score	Luts	Slice Registers	Total RunTime
MapRunTime	host_1	run1	Done	800	51 (1%)	18 (1%)	0h 1m 29s
MapGlobOptLogOptRegDup	host_2	run2	Routing	None	54 (1%)	18 (1%)	0h 1m 35s

For more information about area reporting, see [-area_report \(Area Report Control\)](#).

Custom Strategies

SmartXplorer allows you to create a custom strategy file and enter as many strategies as needed with any combination of options for synthesis, map, and par. You can specify a strategy file through the `-sf` command line argument.

Note The format of the custom strategy file was changed with the introduction of synthesis support. The old strategy format is still supported and can be used if you run SmartXplorer with the implementation flow only. However, you should move to the new strategy file format as soon as possible. In this section we will present both format.

New Custom Strategy File Format

The new custom strategies file allows you to define your own custom synthesis and/or implementation strategies.

Note To avoid errors, make sure that you use a comma (",") after each closing parenthesis (")" and brace (}") except the last brace in the strategy file.

Example (XST)

The following example shows a custom strategy file for use with XST:

```
# This is a custom Strategy file for XST
{
  "spartan6":
  {
    "XST options":
    (
      { "name": "my_xst1",
        "xst": "-opt_level 1 -fsm_extract yes" },
      { "name": "my_xst2",
        "xst": "-opt_level 2 -fsm_extract no" },
    ),
    "Map-Par options":
    (
      { "name": "my_impl1",
        "map": "-timing -ol high -xe n -global_opt on -retiming on ",
        "par": "-ol high" },
      { "name": "my_impl2",
        "map": "-timing -ol high -xe n ",
        "par": "-ol high" },
    ),
  },
}
```

The example above is a strategy file with two synthesis (my_xst1 and my_xst2) and two implementation (my_impl1 and my_impl2) strategies. Both strategies will only be run for a design targeted to a device of the Spartan®-6 family. The example above can be used as a template for a user defined strategy file.

Example (Synplify)

The following example shows a custom strategy file for use with Synplify:

```
# This is a custom Strategy file for Synplify
{
  "spartan6":
  {
    "Synplify options":
    (
      { "name": "my_smpl1",
        "synplify": " set_option -symbolic_fsm_compiler true set_option -default_enum_encoding onehot" },
      { "name": "my_smpl2",
        "synplify": " set_option -symbolic_fsm_compiler false " },
    ),
    "Map-Par options":
    (
      { "name": "my_impl1",
        "map": "-timing -ol high -xe n -global_opt on -retiming on ",
        "par": "-ol high" },
      { "name": "my_impl2",
        "map": "-timing -ol high -xe n ",
        "par": "-ol high" },
    ),
  },
}
```

The example above is a strategy file with two synthesis (my_smpl1 and my_smpl2) and two implementation (my_impl1 and my_impl2) strategies. Both strategies will only be run for a design targeted to a device of the Spartan-6 family. The example above can be used as a template for a user-defined strategy file.

Old Custom Strategy File Format

The old custom strategy file lets you define your own custom implementation strategies only. It does not support synthesis strategies. It allows you to enter as many strategies as needed with any combination of options for map and par. The following example shows a simple strategy file using the old format:

```
{
  "virtex4":
  (
    { "name": "strategy1",
      "map": " -timing -ol high -xe n -global_opt on -retiming on ",
      "par": " -ol high " },
    { "name": "strategy2",
      "map": " -timing -ol high -xe n ",
      "par": " -ol high " }
  ),
}
```

The example above is a strategy file with two strategies named strategy1 (line 4) and strategy 2. (line 7). Both of these strategies will only be run for a design targeted to a device of the Virtex®-4 family (line 2). The example above can be used as a template for a user defined strategy file.

Running SmartXplorer Strategies in Parallel

Running several design strategies (jobs) in parallel will let you complete your project faster. This feature depends on the operating system in use.

- **On a single Linux or Microsoft Windows machine** - SmartXplorer lets you run several strategies in parallel on a single machine if it has a multi-core processor or several processors.
- **On LSF or SGE compute farms** - If you have LSF (Load Sharing Facility) or SGE (Sun Grid Engine) compute farms, LSF or SGE manages jobs distribution. For these compute farms, you must specify the number of machines which can be simultaneously allocated to SmartXplorer.
- **On regular Linux networks** - SmartXplorer can run multiple jobs in parallel on different machines across the network. This can be done in 2 ways:

There are three things that you must know before trying to start SmartXplorer on multiple machines:

- How to set up the Xilinx® software environment on each machine.
- Where SmartXplorer results will be stored.
- How to pass SmartXplorer the list of machines to be used (host list file).

Setting up the Xilinx Environment

When running on more than one machine, the environments on the machines being used must be the same for the results to be valid.

This section shows a regular Linux network in which L1 is used to launch SmartXplorer, and three Linux machines (L1, L2, L3) are used to run design strategies in parallel.

Before launching a job on L2 or L3, SmartXplorer uses the value of \$XILINX from L1 and sets the \$XILINX environment variable on the L2 and L3 machines.

- If Xilinx software is installed on the network, then L2 and L3 must have access to this installation using the same network mount points so that the network paths defined for L1 are valid for all machines.
- If Xilinx software is installed on the L1 local disk, then L2 and L3 must have the same version of Xilinx software installed on a local disk and placed in the directory with same path name as on L1.

The use of environment variables ensures that each design strategy will be run under the same conditions. In addition to \$XILINX, SmartXplorer automatically collects all Xilinx environment variables (having the 'XIL_' prefix) set on L1 and propagates them to the other machines.

The same rules apply to LSF and SGE compute farms – each machine that runs Xilinx software must be able to use the same Xilinx environment as set on the machine running SmartXplorer.

Host List File

To run multiple strategies in parallel on multiple machines, you need a host list file containing a list of the machines to be used by SmartXplorer to run different strategies.

Use the `-l` option in SmartXplorer command line to specify the host file name. For instance:

```
smartxplorer -p xc3s100e-4-vq100 -uc stopwatch.ucf -l
my_hostlist.txt stopwatch.ngc
```

In this context, there are three possible cases:

- A regular Linux network
- LSF or SGE Compute Farms
- Microsoft Windows

Using a Regular Linux Network

In the case of a regular Linux network, specify the list of hosts as shown in the following example (each machine name must be placed on a separate line):

```
host_1
host_2
host_3
host_3
```

The example above uses three machines: host_1, host_2, host_3. Since host_3 is specified twice, SmartXplorer will run two different strategies on this host.

During a SmartXplorer run, the Run Summary from smartxplorer.html shows the host name where each strategy was executed:

Run Summary

Strategy	Host	Output	Status	Timing Score	Luts	Slice Registers	Total RunTime
MapRunTime	host_1	run1	Done	800	51 (1%)	18 (1%)	0h 1m 29s
MapGlobOptLogOptRegDup	host_2	run2	Routing	None	54 (1%)	18 (1%)	0h 1m 35s

Using LSF or SGE Compute Farms

If you are using an LSF or SGE compute farm you still need a host list file, but the information you need to provide is different. The definition format for the two supported compute farms is shown below:

LSF	:LSF {"queue_name": "MYQUEUE", "max_concurrent_runs":N, "bsub_options": "additional_options "}
SGE	:SGE {"queue_name": "MYQUEUE", "max_concurrent_runs":N, "qsub_options": "additional_options "}

queue_name defines the queue name. You must replace *MYQUEUE* with an LSF or SGE queue name.

max_concurrent_runs defines the maximum number of jobs which can be run in parallel. You must replace N with a positive integer value.

bsub_options lets you define additional LSF options and *additional_options* must be replaced by the LSF options. If no options are used, then replace *additional_options* with an empty string: "" (two double quotes)

qsub_options lets you define additional SGE options and *additional_options* must be replaced by the SGE options. If no options are used, then replace *additional_options* with an empty string: "" (two double quotes).

Example

If the queue name is *lin64_q*, the maximum number of parallel jobs is six and there are no specific LSF and SGE options; the host list files should contain the following information:

LSF	:LSF {"queue_name": "lin64_q", "max_concurrent_runs":6, "bsub_options": ""}
SGE	:SGE {"queue_name": "lin64_q", "max_concurrent_runs":6, "qsub_options": ""}

Using a single machine

SmartXplorer lets you run several strategies in parallel on a single machine if it has a multi-core processor or several processors. To run several strategies on the same machine the name of the machine must be listed several times in the host list file:

```
host_1
host_1
host_1
```

In the above example SmartXplorer will run three strategies simultaneously on the *host_1*.

Running on a Single Linux or Windows Machine

If you do not have access to a Linux servers on a network and can only use your local computer, make sure your machine has at least one multi-core processor or several processors.

First you need to estimate how many jobs your machine can run simultaneously.

Theoretically, you can calculate the number of jobs you can run in parallel as follows:

Number of Jobs = P * C

P is the number of processors

C is the number of cores per processor

For instance, if you have 4 dual-core processors, then you can run 8 jobs in parallel.

However, depending on various conditions (for example, available memory or the speed of your hard drive) your computer may not be able to run the maximum number of jobs calculated using the above formula. In this case you may want to reduce the number of jobs you execute simultaneously.

Tips Depending on your calculations following are some tips you can use:













- If you need to run all strategies sequentially because of your design size, run the strategies overnight.
- When trying to solve timing problems, you can work on smaller blocks separately from the rest of the design. If your machine is able deal with multiple strategies in parallel for these blocks, enable parallel jobs to save time.

Results Storage

Results for SmartXplorer strategies are stored in a separate directories: run1, run2, run3, ... These directories are placed in the same disk area and are located in the directory where SmartXplorer is launched, unless the result directory is redefined via `-wd` option. Therefore, all machines must have access to this disk area and read and write permissions.

Windows Results

```
smartxplorer.exe -p xc6vlx75t-ff484-1 -wd results_dir wave_gen.ngd -l hostlist.txt
```

 .smartxplorer	File Folder	2/8/2011 3:0
 run1	File Folder	2/8/2011 3:0
 run2	File Folder	2/8/2011 3:0
 run3	File Folder	2/8/2011 3:0
 run4	File Folder	2/8/2011 3:0
 run5	File Folder	2/8/2011 3:0
 run6	File Folder	2/8/2011 3:0
 run7	File Folder	2/8/2011 3:0
 best_run	1 KB File	2/8/2011 3:1
 smartxplorer.html	17 KB HTML Document	2/8/2011 3:1
 smartxplorer.log	1 KB Text Document	2/8/2011 3:1
 smartxplorer.txt	1 KB Text Document	2/8/2011 3:1
 smartxplorer.xml	7 KB XML Document	2/8/2011 3:1

Linux Results

```
smartxplorer.exe -p xc6vlx75t-ff484-1 -wd results_dir wave_gen.ngd -l hostlist.txt
```

```
Feb  8 15:10 best_run -> /home/siktap/sx_tut/results_dir/run3/
Feb  8 15:09 run1/
Feb  8 15:09 run2/
Feb  8 15:12 run3/
Feb  8 15:09 run4/
Feb  8 15:09 run5/
Feb  8 15:09 run6/
Feb  8 15:09 run7/
Feb  8 15:09 .smartxplorer/
Feb  8 15:10 smartxplorer.html
Feb  8 15:12 smartxplorer.log
Feb  8 15:12 smartxplorer.txt
Feb  8 15:10 smartxplorer.xml
```

There is a separate directory for each run. The example shows the default number of runs, which is seven. The `.smartxplorer` directory is for debug purposes.

Four report files are created:

- `smartxplorer.html` is an HTML file that is dynamically updated while SmartXplorer is running.
- `smartxplorer.log` is a log file containing the same information as the standard output.
- `smartxplorer.txt` is a plain text file that contains the details of strategies that were run.
- `smartxplorer.xml` is an XML file containing the same information as `smartxplorer.txt`

Using Synthesis with SmartXplorer

SmartXplorer supports Xilinx Synthesis Technology (XST) and Synplify synthesis tools. Before running multiple implementation strategies, you can optionally run several synthesis strategies to select the best synthesized netlist for implementation runs.

Note Synthesis in SmartXplorer is supported in command line mode only. It is not supported from the ISE environment.

When you use synthesis with SmartXplorer, the execution becomes a two phase process that includes synthesis and implementation.

- **Phase 1 (Synthesis)** - During this phase, SmartXplorer runs a set of synthesis strategies in order to identify the best synthesized netlist from performance point of view. Please note that in the current release, the synthesis tools do not generate a timing score allowing to select the best results. Each synthesized netlist is run through a single MAP and PAR (further referred as Quick Implementation) using a strategy optimized for runtime in order to obtain a timing score for each netlist.
- **Phase 2 (Implementation)** - During this phase SmartXplorer selects the best synthesized netlist and runs a set of implementation strategies to meet timing requirements.

Note If a timing score of 0 is achieved during either the synthesis or implementation phase, SmartXplorer stops execution. You can use the `-ra` option in the `smartxplorer` command to run all strategies regardless of the achieved timing score.

Running SmartXplorer with Synthesis

To run the synthesis and implementation phases in SmartXplorer, specify one of the following input files:

- XST script file (*design.xst*) for synthesis using XST. For instance:

On Linux -

```
smartxplorer -p xc6slx16-2-csg324 -uc stopwatch.ucf -sd ".;ipcore_dir" stopwatch.xst
```

On Windows -

```
smartxplorer.exe -p xc6slx16-2-csg324 -uc stopwatch.ucf -sd ".;ipcore_dir" stopwatch.xst
```

- Synplify project file (*design.prj*) for synthesis using Synplify. For instance:

On Linux -

```
smartxplorer -p xc6slx16-2-csg324 -uc stopwatch.ucf -sd ".;ipcore_dir" stopwatch.prj
```

On Windows -

```
smartxplorer.exe -p xc6slx16-2-csg324 -uc stopwatch.ucf -sd ".;ipcore_dir" stopwatch.prj
```

Using XST with SmartXplorer

If you use XST as a synthesis tool, you must use the *design.xst* script file to enable synthesis in SmartXplorer. If ISE® Project Navigator is your default design environment, you will find *design.xst* in the project directory. This file is automatically generated by Project Navigator when you launch XST, and it must be used as an input file to launch SmartXplorer. If you use Xilinx® tools in command line mode, then you must use the same *design.xst* script file that you use to run XST in the command line mode.

In order to execute XST strategies in SmartXplorer you should launch SmartXplorer from the directory where the *design.xst* file is located. This will require no adjustments of the *design.xst* file.

Example

```
smartxplorer -p xc6slx16-2-csg324 -uc stopwatch.ucf -wd res_dir  
-sd ".;ipcore_dir" stopwatch.xst
```

This command runs all predefined synthesis and implementation strategies on Linux, and uses XST for synthesis. On Windows, use **smartxplorer.exe** to invoke the program.

Using Synplify with SmartXplorer

If you use Synplify as a synthesis tool you must use the *design.prj* Tcl based script file to enable synthesis in SmartXplorer. This file is automatically created by Synplify. If you use the Synplify GUI, you must use the same *design.prj* file that you use to run Synplify in command line mode.

You must do the following to ensure the correct execution of Synplify from SmartXplorer:

- All references to files and directories in *design.prj* must contain absolute paths. This may require some manual modifications of *design.prj* before running SmartXplorer.
- *design.prj* must contain the **project -run** command. SmartXplorer inserts specific synthesis options corresponding to the synthesis strategies in front of this command.
- In order to execute Synplify strategies in SmartXplorer you should launch SmartXplorer from the directory containing *design.prj*. This will require no additional adjustments to *design.prj*.

Example

```
smartxplorer -p xc6slx16-2-csg324 -uc stopwatch.ucf -wd res_dir
-sd ".;ipcore_dir" stopwatch.prj
```

This command runs all built-in synthesis and implementation strategies on Linux, and uses Synplify for synthesis. On Windows, use **smartxplorer.exe** to invoke the program.

SmartXplorer Reports

There are three reports generated by SmartXplorer.

- `smartxplorer.html` (HTML)
- `smartxplorer.txt` (text)
- `DesignFile_sx.log` (text)

smartxplorer.html

This file is a SmartXplorer report in HTML format. It is located:

- In the Directory where SmartXplorer is launched, if the `-wd` option is not specified or
- In the Directory specified in the `-wd` option

This report consists of several parts, and it is dynamically updated while SmartXplorer is running.

At the start of the report, just below the copyright, is the command used to invoke this SmartXplorer run.

```
smartxplorer -p xc6slx16-3-csg324 -uc stopwatch.ucf -wd res_dir -l my_hostlist.txt -sd ".;ipcore_dir" stopwatch.ngc
```

After the command line is the Run Summary table.

Run Summary

Strategy	Host	Output	Status	Timing Score	Luts	Slice Registers	Total RunTime
MapRunTime	host_1	run1	Done	800	51 (1%)	18 (1%)	0h 1m 29s
MapGlobOptLogOptRegDup	host_2	run2	Routing	None	54 (1%)	18 (1%)	0h 1m 35s
MapGlobOptIOReg	None	None	None	None	None	None	None
MapRegDup	None	None	None	None	None	None	None
MapExtraEffortIOReg	None	None	None	None	None	None	None
MapLogOptRegDup	None	None	None	None	None	None	None
MapExtraEffort2	None	None	None	None	None	None	None

This table contains work progress and the final results summary, and is progressively updated during the run. Each row in this table represents one of the strategies for this run, and by default contains the following information:

- **Strategy** - is the strategy name. Placing your cursor over a strategy name brings a tool tip that displays the synthesis, map and par options used.
- **Host** - indicates the host machine where the strategy was executed. Placing your cursor over the host brings up a tool tip with the type of operating system, how many processors it has, and memory size.
- **Output** - is a link to the log file (*DesignFile_sx.log*). The log files contain the standard output from different steps of the flow (synthesis, map, par) for this strategy when it runs.
- **Status** - reflects the current flow step as synthesis, map, etc.
- **Timing Score** - is the timing score for the strategy. Please note that if the timing score is equal to 0, then all timing constraints were met using this strategy. The underscore under the timing score number indicates a link to the timing report file (*DesignFile.twx.html*).
- **Luts, Slice Registers** - is the area information obtained for the current strategy. It contains two figures. The first one is the absolute number of corresponding resource (for example: number of LUTs). The second one is the utilization percentage in the target FPGA.
Note Area information is extracted from the MAP report. You may add additional area information to the table using the `-area_report` option.
- **Power (mW)** - is the total power for the design. Please note that it is not visible by default. You must specify `-pwo` command line option to run Power Analyzer and display power information in the report table.
- **Total Run Time** - is the total runtime accumulated across the entire flow.

In this example, the first strategy (MapRunTime) has been completed. The process took 1 minute and 29 seconds and the final timing score is 800 (timing constraints were not met). This row has a green background, meaning that this strategy provides the best timing results so far in the current SmartXplorer run. The MapGlobOptLogOptRegDup strategy is still running and it is going through the Routing step. All other strategies have the None status, meaning that they have not been launched yet.

Below the **Run Summary** table is the **Best Strategy** table, which contains the commands (synthesis, map, etc.) for the best strategy.

Best Strategy: MapRunTime (run1), Timing Score: 800, Runtime: 0h 1m 29s

Command Lines

```
map stopwatch.ngd -ol high -w -p xc6slx16-3-csg324 -o stopwatch_map.ncd /home/test/temp/546235/res_dir/run1/stopwatch.pcf

par stopwatch_map.ncd -ol high -w stopwatch.ncd /home/test/temp/546235/res_dir/run1/stopwatch.pcf

trce /home/test/temp/546235/res_dir/run1/stopwatch.ncd /home/test/temp/546235/res_dir/run1/stopwatch.pcf -xml /home/test/temp/546235/res_dir/run1/stopwatch.twx -o /home/test/temp/546235/res_dir/run1/stopwatch.twr
```

Below the **Best Strategy** table is the **Environment Variables** table, which shows platform specific environment variables and Xilinx® specific environment variables.

Environment Variables

Name	Value
PATH	/xilinx/12.1/bin/linux64:/usr/bin:/bin:/usr/X11R6/bin:/usr/local/bin:./home/test/bin:/usr/sbin:/products/valgrind-1.9.6/bin
LD_LIBRARY_PATH	/xilinx/12.1/bin/linux64:/xilinx/12.1/lib/linux64:/usr/lib
XILINX	/xilinx/12.1
LM_LICENSE_FILE	1111@server

smartxplorer.txt

This file is a SmartXplorer report in text format. It is located:

- In the Directory where SmartXplorer is launched, if the **-wd** option is not specified or
- In the Directory specified in the **-wd** option

The smartxplorer.txt file reports details about all the strategies run. It also reports best strategy at the end of the report. Following is a sample of a typical smartxplorer.rpt file (some lines have been removed to save space):

```
-----
Strategy : MapRunTime
-----
Run index                : run1
Map options              : -ol high -w
Par options              : -ol high
Number of Luts           : 51 (1%)
Number of Slice Registers : 18 (1%)
Status                   : Done
Achieved Timing Score    : 900
Current Best (Lowest) Timing Score : 900
Current Best Strategy    : MapGlobOptLogOptRegDup
-----
#####
BestStrategy : MapLogOptRegDup
#####
Run index                : run6
Map options              : -ol high -xe n -logic_opt on -t 2 -w
Par options              : -ol high -xe n
Number of Luts           : 51 (1%)
Number of Slice Registers : 18 (1%)
Achieved Timing Score    : 800
#####
Total Real Time:482.5(secs)
SmartXplorer Done
```

DesignFile_sx.log

This is a log file (text) containing the standard output from different steps of the flow (synthesis, map, par, etc.). This file is created for each run strategy and located in the run[i] directory.

Setting Up SmartXplorer to Run on SSH

SmartXplorer submits jobs to different machines through two different protocols, RSH and SSH. The default protocol is RSH. However, users can specify SSH through the `-r cmd` command line argument. When SSH is used, the user who launches SmartXplorer is required to have SSH configured so no passwords are required. SmartXplorer will not be able to run if SSH requires password. The following sequence of Linux commands can be used to configure SSH so no passwords are needed:

To Set Up SmartXplorer to Run on SSH

1. If you already have an SSH configuration and wish to back it up:

```
$ cp -r $HOME/.ssh $HOME/.ssh.bak
```

2. Run the following commands to generate public and private keys:

```
$ mkdir -p $HOME/.ssh
$ chmod 0700 $HOME/.ssh
$ ssh-keygen -t dsa -f $HOME/.ssh/id_dsa -P ""
```

This should result in two files: `$HOME/.ssh/id_dsa` and `$HOME/.ssh/id_dsa.pub`

3. Run the following commands to configure:

```
$ cd $HOME/.ssh
$ touch authorized_keys2
$ cat id_dsa.pub >> authorized_keys2
$ chmod 0600 authorized_keys2
```

4. Depending on the version of OpenSSH the following commands may be omitted:

```
$ ln -s authorized_keys2 authorized_keys
```

5. You are now set to run SSH without a password. To test, just type:

```
$ ssh <hostname>uname -a
```

Please consult your system administrator if you still require a password with SSH after performing the previous steps.

SmartXplorer Command Line Reference

This section covers the following topics:

- [General Command Line Syntax](#)
- [SmartXplorer Files and Directories](#)
- [SmartXplorer Options](#)

General Command Line Syntax

Following is the command line syntax for SmartXplorer:

```
smartxplorer -p PartNumber [-l HostListFile] [options]
DesignName .edf | .ngd | .ngc | .xst | .prj
```

Note On Windows, you must include the file extension when invoking the program. Use **smartxplorer.exe** instead of **smartxplorer**.

- **-p** (mandatory) specifies the part into which the design is implemented. *PartName* must be a complete Xilinx® part name. See [-p \(Part Name\)](#) for more information.
- *options* can be any combination of SmartXplorer options listed in the [SmartXplorer Options](#) section. Enter options in any order, preceded them with a dash (minus sign on the keyboard) and separate them with spaces.
- *DesignName .edf | .ngd | .ngc | .xst | .prj* is the design file that contains the design you are implementing. The input file type determines the flow which will be used by SmartXplorer.
 - For .edf, .ngd, and .ngc files, SmartXplorer runs implementation strategies only.
 - For .xst (XST script) files, SmartXplorer runs a set of XST synthesis strategies, then selects the best netlist and uses this netlist to run a set of implementation strategies.
 - For .prj (Synplify TCL-based project) files, SmartXplorer runs a set of Synplify synthesis strategies, then selects the best netlist and uses this netlist to run a set of implementation strategies.

SmartXplorer Files and Directories

SmartXplorer uses the files and directories shown below.

SmartXplorer Input Files

File Name	Description
<i>DesignName</i> [.edf .ngd .ngc .xst .prj]	The design file, which specifies the flow to be used during SmartXplorer runs. For more information, see General Command Line Syntax .
<i>filename</i> .ucf	This is a User Constraints File (UCF) containing timing, physical placements, and other constraints. For more information on using this file, see -uc (UCF File) . For more information on constraints, see the Constraints Guide (UG625) .
Host List File (default: smartxplorer.hostlist)	This file contains a list of hosts that the master machine spawns jobs on. For more information, see -l (Host List File) .
Custom Strategies File	This file contains user defined strategies which can be used instead of built-in ones. For more information, see -sf (Strategy File) .
smartxplorer.config	This file is needed to configure the mail server when you use the -n option. For more information, see -n (Notify) .

SmartXplorer Output Directories

Output Directory Name	Description
/run[i]	SmartXplorer will generate as many run[i] directories as the number of strategies run (i being equal to n-1, where n is equal to the total number of strategies run). Each of these directories will contain all of the reports and files generated by synthesis, MAP, PAR, and TRACE set by the associated strategy.

SmartXplorer Output Files

Output File Name	Description
smartxplorer.html	This is a SmartXplorer report in HTML format that dynamically updates while SmartXplorer is running. For more information, see SmartXplorer Reports .
smartxplorer.txt	This file shows details about all of the strategies run, and reports the best strategy at the end of the report. For more information, see SmartXplorer Reports
<i>DesignName_sx.log</i>	This log file contains the standard output from different steps of the flow (synthesis, MAP, PAR, etc.). This file is created for each run strategy and located in the run[i] directory. For more information, see SmartXplorer Reports

SmartXplorer Options

The following command line options are available for SmartXplorer.

- [-area_report](#) (Area Report Control)
- [-b](#) (Batch Mode)
- [-best](#) (Best N Runs)
- [-bo](#) (BitGen Options)
- [-cr](#) (Congestion Reduction)
- [-l](#) (Host List File)
- [-la](#) (List All Strategies)
- [-lsr](#) (Limit Synthesis Runs)
- [-m](#) (Max Runs)
- [-max_score](#) (Max Score)
- [-max_time](#) (Max Time)
- [-mo](#) (MAP Options)
- [-n](#) (Notify)
- [-p](#) (Part Number)
- [-po](#) (PAR Options)
- [-pwo](#) (Power Options)
- [-ra](#) (Run All Strategies)
- [-rcmd](#) (Remote Command)
- [-sd](#) (Source Directory)
- [-sf](#) (Strategy File)
- [-to](#) (TRCE Options)
- [-uc](#) (UCF File)
- [-vp](#) (Variability Passes)
- [-wd](#) (Write Directory)

-area_report (Area Report Control)

This option lets you control the area data which is displayed in SmartXplorer reports.

By default SmartXplorer reports show the number of LUTs and Slice Registers.

Strategy	Host	Output	Status	Timing Score	Luts	Slice Registers	Total RunTime
MapRunTime	host_1	run1	Done	800	51 (1%)	18 (1%)	0h 1m 4s

Two values are displayed for each FPGA resource.

- The first value is the absolute number of the corresponding FPGA resource (in the above example the design implementation uses 51 LUTs)
- The second value (in parentheses) is the utilization percentage for the target FPGA (in the above example the design uses only 1% of the available LUTs)

Syntax

`-area_report [on|off|column_spec]`

On (the default) turns the Area Report on and displays the number of LUTs and Slice Registers.

Off turns the Area Report off.

column_spec lets you modify the columns that are shown in the table. You can specify multiple values simultaneously by putting the values between double quotes and separating the values with ";" (semicolons). The order of values represents the order of corresponding columns in the generated table.

Option	Column Name
lut	LUTs
slice_reg	Slice Registers
slice	Slices
bram	BRAMs
dsp48	DSP48s
mult18x18	MULT18x18s

Note In the case of BRAMs only the absolute number of BRAMs used is provided.

Example

`-area_report "slice;lut;dsp48"`

Strategy	Host	Output	Status	Timing Score	Slices	Luts	DSP48s	Total RunTime
MapRunTime	host_1	run1	Done	800	21 (1%)	51 (1%)	0 (0%)	0h 1m 5s

-b (Batch Mode)

This option runs SmartXplorer in batch mode.

By default SmartXplorer updates standard output in real time. As a result, the output cannot be redirected to a file and SmartXplorer cannot be run as a background process. Use `-batch_mode` to redirect screen output to a file or to run SmartXplorer in the background.

Syntax

`-b`

`-batch_mode`

-best (Best N Runs)

This option saves the best "N" results of the SmartXplorer. All of the other results will be deleted by SmartXplorer, but the strategies, reports, and log files will be retained.

Syntax

-best

-best_n_runs *results*

results is the number of results to retain.

-bo (BitGen Options)

This option lets you override BitGen options. By default BitGen will automatically create a programming data file based on the best run of SmartXplorer. If you specify a file, the options included in the file will be used by BitGen. To prevent BitGen from running, use **-bo off**.

Syntax

-bo

-bitgen_options *options_file* | **off**

options_file is a file containing the options that you want BitGen to use when it runs.

off specifies that BitGen should not run.

Note When specifying the options file, only absolute paths should be used. BitGen does not validate the options in the options file and does not resolve paths included in this file.

-cr (Congestion Reduction)

This option instructs SmartXplorer to run dedicated built-in implementation (MAP and PAR) strategies for congestion reduction (to improve routability) for 7 series, Virtex®-6, and Spartan®-6 families. These dedicated strategies will be used instead of the standard built-in strategies created for the devices.

Syntax

-cr

-congestion_reduction

Note To list the congestion reduction strategies use **-cr** and **-la** together.

-l (Host List File)

This option specifies a host list file, which contains a list of machine names to use for running SmartXplorer strategies.

Syntax

-l *host_list_file*

-host_list *host_list_file*

By default, SmartXplorer will look for a file named `smartxplorer.hostlist` in launch directory. If you use this file, you do not need to use the **-l** option. For more information on host lists, see [Host List File](#).

-la (List All Strategies)

This option tells SmartXplorer to list all built-in strategies for a given device family. When using this option, SmartXplorer only lists the strategies and exits. It does not spawn any jobs.

Syntax

```
-la
-list_all_strategies
```

Note This option must be used with the **-part** option to get a listing of all the strategies.

- To list XST synthesis and implementation strategies, specify an XST script file (*DesignName.xst*) as an input file. For instance, **-p xc6slx16-3-csg324 -la stopwatch.xst**
- To list Synplify synthesis and implementation strategies, specify a Synplify project file (*DesignName.prj*) as an input file. For instance, **-p xc6slx16-3-csg324 -la stopwatch.prj**
- To list implementation strategies only, specify the NGC file or no file as an input file. For instance, **-p xc6slx16-3-csg324 -la stopwatch.ngc** or just **-p xc6slx16-3-csg324 -la**

Example

The following example shows implementation strategies displayed by this option (some lines have been removed to conserve space).

```
smartxplorer -p xc6slx16-3-csg324 -la

===== List Of Strategies for Part xc6slx16-3-csg324 =====

Strategy MapRunTime:
-----
map options:  -ol high -w
par options:  -ol high

Strategy MapGlobOptIOReg:
-----
map options:  -ol high -global_opt speed -pr b -w
par options:  -ol high -xe n
```

-lsr (Limit Synthesis Runs)

This option tells SmartXplorer to limit the number of synthesis (Synplify Pro) strategies that can run in parallel in order to make sure that the process does not use more Synplify Pro licenses than specified.

Note This option is applicable only with Synplify Pro.

Syntax

```
-lsr num_licenses
-limit_synthesis_runs num_licenses
```

num_licenses is an integer representing the largest number of licenses the process should grab, and thus the largest number of strategies that can be run in parallel.

-m (Max Runs)

This option specifies the number of strategies to be run by SmartXplorer. Please see [Using the Built-In Strategies](#) for more information.

Syntax

-m *number_of_runs*

-max_runs *number_of_runs*

If you do not specify **-m**, SmartXplorer runs all built-in or custom strategies (please note that if the timing score of 0 is achieved, SmartXplorer stops execution).

Note **-vp** and **-m** cannot be used together.

-max_score (Max Score)

Use this command to interrupt a strategy if the setup score in PAR exceeds a specified value.

Syntax

-max_score *maxSetupScore*

-max_setup_score *maxSetupScore*

maxSetupScore is the PAR setup score value.

Example

-max_score 1000

This example kills the currently running strategy if the setup score in PAR exceeds 1000.

-max_time (Max Time)

Use this option to interrupt a strategy if the run time exceeds a specified value.

Syntax

-max_time *maxTimeOut*

-max_time_out *maxTimeOut*

maxTimeOut is the maximum run time value specified as "hrs:min:sec" and must be enclosed in double quotes.

Example

-max_time "01:30:45"

This example kills the currently running strategy if the run time exceeds one hour, 30 minutes, and 45 seconds.

-mo (MAP Options)

This option overrides all MAP options.

Syntax

-mo *options*

-map_options *options*

options are any of the MAP options listed in the MAP chapter. You must enclose these options in double quotes.

When you use `-mo`, the specified options will be applied to every strategy, overriding MAP options specified in built-in or custom strategies.

The names of the overridden strategies will be marked with a "*" character in the report, showing that the strategy options were overridden with the options specified in the SmartXplorer command line:

Run Summary

Strategy	Host	Output	Status	Timing Score	Luts	Slice Registers	Total RunTime
MapRunTime*	host_1	run1	Routing	None	51 (1%)	18 (1%)	0h 0m 44s

Note If you use both `-mo` and `-po`, all strategy files will be ignored, and only the one specified through `-mo` and `-po` will be run.

Example

```
-mo "-ol high -w"
```

This example overrides all MAP options during the SmartXplorer run and replaces them with the options enclosed in double quotes.

-n (Notify)

This option tells SmartXplorer to send an email or a cell phone text message after all jobs are completed. This message contains:

- The best timing score achieved.
- The smartxplorer.txt report file (for more information, please see [SmartXplorer Reports](#)).

Note Cell phone text messaging is only supported if the destination cell phone subscription supports text messaging. This feature is only available in North America.

Syntax

```
-n "useraddr [ ; useraddr [ ; ... ] ]"
```

```
-notify "useraddr [ ; useraddr [ ; ... ] ]"
```

The notify list is specified in quotes with a ";" (semicolon) separating each email address or cell phone number. Any email addresses or cell phone numbers provided are notified when the SmartXplorer run has completed.

Example

```
-notify='user1@myCompany.com,user2@myCompany.com,8005551234'
```

Mail Server Setup

By default, SmartXplorer uses the local host as the mail server (SMTP) to send E-mails. You can override this by setting the XIL_SX_MAIL_SERVER environment variable in the smartxplorer.config file, as shown below:

```
# Sample "smartxplorer.config" File for Mail Server Configuration
# -----
{
"XIL_SX_MAIL_SERVER": "E-mail_Server.my_comp.com",
}
# End of file
```

Note SmartXplorer will not read the `smartxplorer.config` file unless you set the `XIL_SX_USE_CONFIG_FILE` environment variable to a value of 1.

-p (Part Number)

This option specifies the part into which your design is implemented.

Syntax

`-p part number`

`part number` must be a complete Xilinx® part name including device, package and speed information (example: `xc4vlx60-10-ff256`).

Note For syntax details and examples, see [-p \(Part Number\)](#) in the Introduction chapter.

-po (PAR Options)

This option overrides all PAR options.

Syntax

`-po options`

`-par_options options`

`options` are any of the PAR options listed in the PAR chapter. You must enclose these options in double quotes.

When you use `-po`, the specified options will be applied to every strategy, overriding PAR options specified in built-in or custom strategies.

The names of the overridden strategies will be marked with a "*" character in the report, showing that the strategy options were overridden with the options specified in the SmartXplorer command line:

Run Summary

Strategy	Host	Output	Status	Timing Score	Luts	Slice Registers	Total RunTime
MapRunTime*	host_1	run1	Routing	None	51 (1%)	18 (1%)	0h 0m 44s

Note If you use both `-mo` and `-po`, all strategy files will be ignored, and only the one specified through `-mo` and `-po` will be run.

Example

`-po "-ol high -xe n"`

This example overrides all PAR options during the SmartXplorer run and replaces them with the options enclosed in double quotes.

-pwo (Power Options)

This option tells SmartXplorer to run XPower Analyzer for the placed and routed design and report the total power consumption for the design in the `smartxplorer.html` and `smartxplorer.txt` report files.

When you specify `-pwo`, the power information is placed in the **Power (mW)** column as shown below:

Run Summary

Strategy	Host	Output	Status	Timing Score	Luts	Slice Registers	Power (mW)	Total RunTime
MapRunTime	host_1	run1	Done	800	51 (1%)	18 (1%)	49.06	0h 1m 15s

Syntax

`-pwo` [`off` | `on` | *options*]

`-power_options` [`off` | `on` | *options*]

`off` (the default)

`on` runs XPower Analyzer with its default options.

options runs XPower Analyzer with the specified options. Options can be any of the options specified in the XPWR chapter, and they must be enclosed in double quotes.

Note If an option takes a file as an input to a switch, only absolute paths should be provided for input files and only file names should be provided for output files.

Example

```
-pwo "-v"
```

This example runs XPower Analyzer with the `-v` option on the placed and routed design, and reports the total power consumption for the design.

-ra (Run All Strategies)

This option tells SmartXplorer to run all built-in or user defined strategies.

By default, SmartXplorer saves the best results and exits whenever any of the strategies meets timing (timing score is equal to 0). Use `-ra` to override this behavior and continue to run until all strategies have completed.

Syntax

`-ra`

`-run_all_strategies`

-rcmd (Remote Command)

This option specifies which program to use for logging into remote hosts and executing commands on the host.

Syntax

`-rcmd` [`rsh` | `ssh`]

`-remote_command` [`rsh` | `ssh`]

Allowed values are `rsh` or `ssh`. The default is `rsh`.

-sd (Source Directory)

This option gives users the ability to search other path lists for design files. This is often used when there are CORE Generator™ or other generated intermediate netlists that are not in the design directory.

Syntax

```
-sd "source_dir_path ; [source_dir_path ] ; ..."  
-source_dir "source_dir_path ; [source_dir_path ] ; ..."
```

Specify the path list in double quotes with the directories in the path list separated by ";" (semicolon). The default value is the directory where SmartXplorer is invoked.

Example

```
-source_dir  
"path_to_directory1 ; path_to_directory2 ; path_to_directory3"
```

This example tells SmartXplorer to search in path_to_directory1, path_to_directory2, and path_to_directory3 before searching in the design directory.

-sf (Strategy File)

This option specifies a custom strategy file that overrides the built-in strategies in SmartXplorer. For more information, see [Using Custom Strategies](#).

Syntax

```
-sf strategy_file  
-strategy_file strategy_file
```

-to (TRCE Options)

By default TRCE generates a compact form of the timing report when it is run from SmartXplorer. This option lets you override default TRCE behavior and personalize the TRCE report for your needs, for example by creating a verbose report.

Syntax

```
-to options
```

options are any of the TRCE options listed in the TRCE chapter, and must be specified in double quotes.

Note If an option takes a file as an input to a switch, only absolute paths should be provided for input files and only file names should be provided for output files.

Example

```
-to "-v 10"
```

This example runs TRCE with the `-v` option set to 10.

-uc (UCF File)

This option specifies a User Constraints File (UCF) for the design. This file may contain timing, physical placement and other constraints. For more information on constraints, see the [Constraints Guide \(UG625\)](#).

Syntax

```
-uc ucf_file
```

-ucf *ucf_file*

If you do not use **-uc**, SmartXplorer looks for *design_name*.ucf. If the specified UCF is not found, SmartXplorer looks in the directory specified using the **-sd** option. If multiple files with the same name are encountered, SmartXplorer uses the first UCF it encounters with the name.

Note If an NGD file is specified as an input design file, then a UCF is not necessary since all timing, placement, and other attributes are incorporated in the NGD file.

SmartXplorer supports multiple UCF constraint files. To specify multiple files, specify the file list in double quotes with the files separated by “;”.

Example

```
-uc "file1.ucf;file2.ucf"
```

In this example, SmartXplorer will look for *file1.ucf* and *file2.ucf* in the directory specified using **-sd**.

-vp (Variability Passes)

This option runs SmartXplorer using a specific strategy (base strategy) with different Cost Tables to further improve timing. The base strategy (MAP and PAR options) can be specified:

- Directly in the SmartXplorer command using **-mo** and **-po**.
- In a custom strategy file.

This option defines the number of cost tables to be used in this mode. For more information, see [Using SmartXplorer](#).

Syntax

```
-vp number_of_cost_tables
```

```
-variability_passes number_of_cost_tables
```

Note **-vp** and **-m** cannot be used together.

-wd (Write Directory)

This option specifies where to write the output results. If this option is omitted (the default) SmartXplorer writes the results in the directory from which SmartXplorer was invoked.

Syntax

```
-wd write_dir_path
```

```
-write_dir write_dir_path
```

XPWR

This chapter is about the XPWR command line tool.

XPWR Overview

XPWR provides power and thermal estimates after PAR, for FPGA designs, and after CPLDFit, for CPLD designs. XPWR does the following:

- Estimates how much power the design will use
- Identifies how much power each net or logic element in the design is using
- Verifies that junction temperature limits are not exceeded

XPWR Device Support

This program is compatible with the following device families:

- 7 series
- Spartan®-3, Spartan-3A, Spartan-3E, and Spartan-6
- Virtex®-4, Virtex-5, and Virtex-6
- CoolRunner™ XPLA3 and CoolRunner-II

Files Used by XPWR

XPWR uses the following file types:

- **CXT** - A file produced by CPLDFit and used by XPWR to calculate and display power consumption.
- **NCD** - A physical design file produced by MAP and PAR that contains information on an FPGA. You should use a fully placed and routed NCD design (produced by PAR) to get the most accurate power estimate. Using a mapped-only NCD (produced by MAP) file may compromise accuracy.
- **PCF** - An optional ASCII Physical Constraints File (PCF) produced by MAP. The PCF contains timing constraints that XPWR uses to identify clock nets switching rates (by using the period constraint). Temperature and voltage information is also available if these constraints have been set in the User Constraints File (UCF).
- **VCD** - An output file from simulators. XPWR uses this file to set frequencies and activity rates of internal signals, which are signals that are not inputs or outputs but internal to the design. For a list of supported simulators, see the [Using XPWR](#) section of this chapter.
- **SAIF** - An output file from simulators that provides a more condensed form of switching data. SAIF is generally considerably smaller and processes much faster than VCD yet should provide similar results.
- **XPA** - A settings file from XPWR. Settings such as frequencies, toggle rates, and capacitance loads can be saved to this file, which can be referenced later to avoid entering the same information the next time the design is loaded into XPWR.
- **PWR (Text Power Report)** - Analysis results can be saved in a text file for project documentation or parsing from user scripts. By default this file contains all data presented in the Graphical interface “Project Settings” and “Summary” views. The verbose mode adds the remaining views
- **XPE (Interoperability File)** - This analysis result report can be exported for further analysis into XPower Estimator spreadsheet. It includes all environment, settings and design data.

XPWR Syntax

Use the following syntax to run XPWR from the command line for FPGA devices:

```
xpwr [options] infile [.ncd] [constraints_file [.pcf]]
```

Use the following syntax to run XPWR from the command line for CPLD devices:

```
xpwr [options] infile [.cxt]
```

options is one or more of the XPWR options listed in [XPWR Command Line Options](#). Enter options in any order, preceded them with a dash (minus sign on the keyboard) and separate them with spaces.

infile is the name of the input physical design file. If you enter a filename with no extension, XPWR looks for an NCD file with the specified name. If no NCD file is found, XPWR looks for a CXT file.

constraints_file is the name of the Physical Constraints File (PCF). This optional file is used to define timing constraints for the design. If you do not specify a PCF, XPWR looks for one with the same root name as the input NCD file. If a CXT file is found, XPWR does not look for a PCF file.

XPWR Command Line Options

The following command line options are available for XPWR.

- `-filter` (Write Filter File)
- `-l` (Limit)
- `-ls` (List Supported Devices)
- `-s` (Specify SAIF or VCD file)
- `-o` (Rename Power Report)
- `-ol` (Analysis Effort Level)
- `-tcl` (Tcl Script)
- `-v` (Verbose Report)
- `-wx` (Write XPA Settings File)
- `-x` (Specify XPA Settings File)
- `-xpe` (Write XPE File)

To get a list of these options from the command line, run `xpwr -h`.

-filter (Write Filter File)

This option will generate a message filter file to be used with message filtering in the XReport application.

Syntax

```
-filter [userdata.filter]
```

`userdata.filter` is the file which contains filter information.

-l (Limit)

This option imposes a line limit on the verbose report.

Syntax

```
-l limit
```

`limit` is the maximum number of lines to print in a verbose report.

-ls (List Supported Devices)

This option lists the supported Xilinx® devices in the current software installation. You can restrict the list to a specific architecture.

Syntax

```
-ls [-arch architecture]
```

`architecture` is the architecture for which you want a device list. For example, `virtex6`

-o (Rename Power Report)

Specifies the name of the output power report file.

Syntax

```
-o reportname [.pwr]
```

reportname is the name of the power report.

If the extension is not specified, the output power report name is the specified file name with a `.pwr` extension.

-ol (Analysis Effort Level)

This option sets the effort level the tool will use to analyze the design.

Syntax

```
-ol std|high
```

You should start with standard effort level early in the design cycle and move to high effort level towards the final analysis runs. The default is `std`. A `high` effort will increase accuracy and also runtime as it invokes the ISim simulator to estimate DSP block activity.

Note This option is available for Spartan®-6, Virtex®-6, and all 7 series devices

-s (Specify Input Simulation SAIF or VCD file)

This option sets activity rates and signal frequencies using data from an SAIF or VCD file.

Syntax

```
-s simdata[.saif|.vcd]
```

simdata is the name of the SAIF or VCD file to use.

If the extension is not specified the program will look for a file with a `.vcd` extension first, then for a file with a `.saif` extension.

-tcl (Tcl Script)

This option specifies a Tcl script that can be used to apply settings.

Syntax

```
-tcl tcl_script
```

tcl_script is the Tcl script to be used to apply settings.

-v (Verbose Report)

This option specifies a verbose (detailed) power report.

Syntax

```
-v
```

See [Power Reports](#) for more information.

-wx (Write XPA Settings File)

This option instructs XPWR to create an XPA settings file that contains all of the settings information from the current XPWR run.

Syntax

```
-wx outputSettingsFile [.xpa]
```

outputSettingsFile is the file in which to store settings information.

If no extension is specified, the output file name is the specified file name with a `.xpa` extension.

-x (Read XPA Settings File)

This option instructs XPWR to use an existing XPA settings file to set the frequencies of signals and other values. This file can be generated from a previous XPWR session or exported from the XPower Estimator spreadsheet.

Syntax

```
-x InputSettingsFile [ .xpa ]
```

InputSettingsFile is the file from which to get settings information.

If no extension is specified, XPWR searches for the specified file name with a `.xpa` extension.

-xpe (Write XPE File)

This option will generate a file with design utilization, activity, and settings information which can then be imported into XPower Estimator (XPE) to perform further analysis. For more information on this flow see the *Power Methodology Guide (UG786)* and the *XPower Estimator User Guide (UG440)*.

Syntax

```
-xpe outputFile [ .xpe ]
```

outputFile is the file containing the design information. If no extension is specified, the output file name is the specified file name with a `.xpe` extension.

XPWR Command Line Examples

The following command produces a standard report, `mydesign.pwr`, in which the SAIF file specifies the activity rates and frequencies of signals. The output loading has not been changed; all outputs assume the default loading of 10pF. The design is for FPGAs.

```
xpwr -s timesim.saif mydesign.ncd mydesign.pcf
```

The following command does all of the above and generates a settings file called `mysettings.xpa`. The settings file contains all of the information from the SAIF file.

```
xpwr -s timesim.saif -wx mysettings.xpa mydesign.ncd mydesign.pcf
```

The following command does all of the above and generates a detailed (verbose) report instead of a standard report. The verbose report is limited to 100 lines per table.

```
xpwr -v -l 100 -s timesim.saif -wx mysettings.xpa mydesign.ncd mydesign.pcf
```

Using XPWR

This section describes the settings necessary to obtain accurate power and thermal estimates, and the methods that XPWR allows. This section refers specifically to FPGA designs.

SAIF or VCD Data Entry

The recommended XPWR flow uses a SAIF or VCD file generated from post PAR simulation. To generate an SAIF or VCD file, you must have a Xilinx® supported simulator. See the [Synthesis and Simulation Design Guide \(UG626\)](#) for more information.

Note Due to the increased size and processing time necessary for a VCD file compared to an SAIF, SAIF is generally recommended.

XPWR supports the following simulators:

- ISim
- Mentor Graphics ModelSim
- Cadence NC-SIM
- Synopsys VCS and VCS MX

XPWR uses the SAIF or VCD file to set toggle rates and frequencies of all the signals in the design.

Even though you are providing design activity information, remember to provide the following information:

- Voltage (if different from the recommended databook values)
- Ambient temperature (default is 25 degrees C)
- Output loading (capacitance and current due to resistive elements)

For the first XPWR run, voltage and ambient temperature can be applied from the PCF, provided temperature and voltage constraints have been set.

To save time if the design is reloaded into XPWR, you can create a settings file (XPA). All settings (voltage, temperature, frequencies, and output loading) are stored in the settings file. See the [-wx \(Write XPA File\)](#) section of this chapter for more information.

Other Methods of Data Entry

All asynchronous signals are set using an absolute frequency in MHz. All synchronous signals are set using activity rates.

An activity rate is a percentage between 0 and 100. It refers to how often the output of a registered element changes with respect to the active edges of the clock. For example, a 100MHz clock going to a flip flop with a 100% activity rate has an output frequency of 50MHz.

When using other methods of design entry, you must set the following:

- Voltage (if different from the recommended databook values)
- Ambient temperature (default is 25 degrees C)
- Output loading (capacitance and current due to resistive elements)
- Frequency of all input signals
- Activity rates for all synchronous signals

If you do not set activity rates, XPWR assumes the following:

- 12.5% toggling rate of the synchronizing clock for synchronous elements
- 12.5MHz for asynchronous elements
- 0MHz for unspecified clock nets

The frequency of input signals is assumed to be 0MHz. The default ambient temperature is 25 degrees C. The default voltage is the recommended operating voltage for the device.

Note The accuracy of the power and thermal estimates is compromised if you do not set all of the above mentioned signals. At a minimum, you should set high power consuming nets, such as clock nets, clock enables, and other fast or heavily loaded signals and output nets.

Power Reports

This section explains what you can expect to see in a power report. Power reports have a `.pwr` extension.

There are three types of power reports:

- Standard Reports (the default)
- Detailed Reports (the report generated when you run the `-v` (Verbose Report) command line option)

Standard Reports

A standard report contains the following:

- A report header specifying:
 - The XPWR version
 - A copyright message
 - Information about the design and associated files, including the design filename and any PCF and simulation files loaded
 - The data version of the information
- The Power Summary, which gives the power and current totals as well as other summary information.
- The Thermal Summary, which consists of:
 - Airflow
 - Estimated junction temperature
 - Ambient temperature
 - Case temperature
 - Theta J-A
- A total current for each voltage source broken down in individual capacitance ranges.
- A footer containing the analysis completion date and time.

Detailed Report

A detailed power report includes all of the information in a standard power report, plus power details listed for for each architecture resource type used in by the design (logic, signals, clocks, inputs, outputs, etc.).

PIN2UCF

This chapter describes PIN2UCF.

PIN2UCF Overview

PIN2UCF is a Xilinx® command line tool that back-annotates pin-locking constraints to a User Constraints File (UCF).

For FPGA devices, PIN2UCF:

- Requires a successfully placed and routed design
- Reads a Native Circuit Description (NCD) file

For CPLD devices, PIN2UCF:

- Requires a successfully fitted design
- Reads a Guide (GYD) file

PIN2UCF writes its output to an existing UCF. If there is no existing UCF, PIN2UCF creates one.

PIN2UCF Design Flow

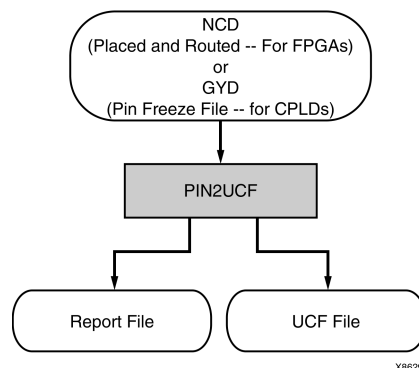

PIN2UCF Device Support

This program is compatible with the following device families:

- 7 series
- Spartan®-3, Spartan-3A, Spartan-3E, and Spartan-6
- Virtex®-4, Virtex-5, and Virtex-6
- CoolRunner™ XPLA3 and CoolRunner-II
- XC9500 and XC9500XL

PIN2UCF File Types

File	Type	Acronym	Devices	Extension
Native Circuit Description	Input	NCD	FPGA	.ncd
Guide	Input	GYD	CPLD	.gyd
Report	Output	RPT	FPGA and CPLD	.rpt
User Constraints File	Output	UCF	FPGA and CPLD	.ucf

PIN2UCF Input File

FPGA Designs -The PIN2UCF input for FPGA designs is a Native Circuit Description (NCD) file. The minimal input is a placed NCD file. The optimal input is a fully mapped, placed, and routed NCD file that meets (or nearly meets) timing specifications.

CPLD Designs -The PIN2UCF input for CPLD designs is a Guide (GYD) file. PIN2UCF replaces the former GYD file mechanism used to lock pins in CPLD designs. Although a GYD file may still be used to control pin-locking, Xilinx recommends running PIN2UCF instead of specifying a GYD file.

PIN2UCF Output Files

This section discusses PIN2UCF Output Files and includes:

- [PIN2UCF User Constraints Files \(UCF\)](#)
- [PIN2UCF Pin Report Files](#)

PIN2UCF User Constraints Files (UCF)

This section discusses PIN2UCF User Constraints Files (UCF) and includes:

- About PIN2UCF User Constraints Files (UCF)
- PIN2UCF User Constraints Files (UCF) PINLOCK Section
- Writing to PIN2UCF User Constraints Files (UCF)
- PIN2UCF User Constraints Files (UCF) Comments

About PIN2UCF User Constraints Files (UCF)

PIN2UCF writes the information from the input file to a User Constraints File (UCF). If there is no existing UCF, PIN2UCF creates one. If an output .ucf file is not specified for PIN2UCF, and a UCF with the same root name as the design exists in the same directory as the design file, PIN2UCF writes to that file automatically unless there are constraint conflicts. For more information, see “Writing to PIN2UCF User Constraints Files (UCF)” below.

PIN2UCF User Constraints Files (UCF) PINLOCK Section

PIN2UCF writes pin-locking constraints to a PINLOCK section in the User Constraints File (UCF). The PINLOCK section:

- Begins with the statement #PINLOCK BEGIN
- Ends with the statement #PINLOCK END

By default, PIN2UCF does not write conflicting constraints to a UCF.

User-specified pin-locking constraints are never overwritten in a UCF. However, if the user-specified constraints are exact matches of PIN2UCF-generated constraints, PIN2UCF adds a pound sign (#) before all matching user-specified location constraint statements. The pound sign indicates that a statement is a comment.

To restore the original UCF (the file without the PINLOCK section):

- Remove the PINLOCK section
- Delete the pound sign (#) from each of the user-specified statements

PIN2UCF does not check to see if existing constraints in the UCF are valid pin-locking constraints.

Writing to PIN2UCF User Constraints Files (UCF)

PIN2UCF writes to a User Constraints Files (UCF) under the conditions shown below:

PIN2UCF Behavior

Condition	PIN2UCF Behavior	Files Created or Updated
No UCF is present.	PIN2UCF creates a UCF and writes the pin-locking constraints to the UCF.	pinlock.rpt <i>design_name.ucf</i>
UCF is present. The contents in the PINLOCK section are all pin lock matches, and there are no conflicts between the PINLOCK section and the rest of the UCF. The PINLOCK section contents are all comments and there are no conflicts outside of the PINLOCK section. There is no PINLOCK section and no other conflicts in the UCF.	PIN2UCF writes to the existing UCF.	pinlock.rpt <i>design_name.ucf</i>
UCF is present. There are no pin-locking constraints in the UCF, or this file contains some user-specified pin-locking constraints outside of the PINLOCK section. None of the user-specified constraints conflict with the PIN2UCF generated constraints.	PIN2UCF writes to the existing UCF. PIN2UCF appends the pin-locking constraints in the PINLOCK section to the end of the file.	pinlock.rpt <i>design_name.ucf</i>
UCF is present. The UCF contains some user-specified pin-locking constraints either inside or outside of the PINLOCK section. Some of the user-specified constraints conflict with	PIN2UCF writes to the existing UCF. PIN2UCF does not write the PINLOCK section. Instead, it exits after providing an error message. It writes a list of conflicting constraints.	pinlock.rpt

Condition	PIN2UCF Behavior	Files Created or Updated
the PIN2UCF generated constraints		
UCF is present. There are no pin-locking constraints in the UCF. There is a PINLOCK section in the UCF generated from a previous run of PIN2UCF or manually created by the user. None of the constraints in the PINLOCK section conflict with PIN2UCF generated constraints.	PIN2UCF writes to the existing UCF. PIN2UCF writes a new PINLOCK section in the UCF after deleting the existing PINLOCK section. The contents of the existing PINLOCK section are moved to the new PINLOCK section.	pinlock.rpt <i>design_name.ucf</i>

PIN2UCF User Constraints Files (UCF) Comments

Comments inside an existing PINLOCK section in a PIN2UCF User Constraints File (UCF) are never preserved by a new run of PIN2UCF. If PIN2UCF finds a CSTTRANS comment, it equates INST *name* to NET *name* and then checks for comments.

PIN2UCF Pin Report Files

If PIN2UCF discovers conflicting constraints before creating a PINLOCK section in a User Constraints Files (UCF), it writes to a Report file named `pinlock.rpt`. The Report file is written to the current directory by default. Use the `pin2ucf -r` command line option to write a Report file to another directory. For more information, see [PIN2UCF -r \(Write to a Report File\)](#).

The Report file has the following sections:

- PIN2UCF Constraints Conflicts Information
- PIN2UCF List of Errors and Warnings

PIN2UCF Constraints Conflicts Information

The Constraints Conflicts Information section in a PIN2UCF Report file has the following subsections.

- Net name conflicts on the pins
- Pin name conflicts on the nets

If there are no conflicting constraints, both subsections contain a single line indicating that there are no conflicts

The Constraints Conflicts Information section does not appear if there are fatal input errors, such as missing inputs or invalid inputs.

PIN2UCF List of Errors and Warnings

The List of Errors and Warnings section in a PIN2UCF Report file appears only if there are errors or warnings.

PIN2UCF Syntax

The PIN2UCF command line syntax is:

```
pin2ucf ncd_file.ncd|pin_freeze_file.gyd [-rreport_file_name -o  
output.ucf]
```

- *ncd_file* is the name of the placed and routed NCD file for FPGA devices, or
- *pin_freeze_file* is the name of the fitted GYD file for CPLD devices

PIN2UCF Command Line Options

This section describes the PIN2UCF command line options.

- [PIN2UCF -o \(Output File Name\)](#)
- [PIN2UCF -r \(Write to a Report File\)](#)

-o (Output File Name)

PIN2UCF by default writes a User Constraints Files (UCF) file named *ncd_file.ucf*. Use this option to:

- Write a UCF with a different root name than the design name
- Write the pin-locking constraints to a UCF with a different root name than the design name
- Write the UCF to a different directory

Syntax

```
-o outfile.ucf
```

-r (Write to a Report File)

PIN2UCF by default writes a Report file named *pinlock.rpt*. Use this option to write a Report file with a different name.

Syntax

```
-r report_file_name.rpt
```

TRACE

This chapter is about the Timing Reporter And Circuit Evaluator (TRACE) tool,.

TRACE Overview

The Timing Reporter And Circuit Evaluator (TRACE) tool provides static timing analysis of an FPGA design based on input timing constraints.

TRACE performs two major functions:

- **Timing Verification** - Verifies that the design meets timing constraints.
- **Reporting** - Generates a report file that lists compliance of the design against the input constraints. TRACE can be run on unplaced designs, only placed designs, partially placed and routed designs, and completely placed and routed designs.

The following figure shows the primary inputs and outputs to TRACE. The Native Circuit Description (NCD) file is the output design file from MAP or PAR, which has a .ncd extension. The optional Physical Constraints File (PCF) has a .pcf extension. The TWR file is the timing report file, which has a .twr extension.

TRACE flow with primary input and output files

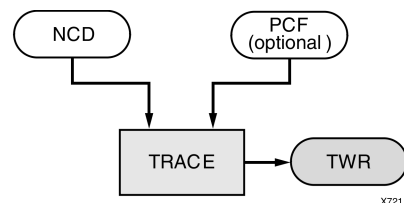

TRACE Device Support

This program is compatible with the following device families:

- 7 series
- Spartan®-3, Spartan-3A, Spartan-3E, and Spartan-6
- Virtex®-4, Virtex-5, and Virtex-6
- CoolRunner™ XPLA3 and CoolRunner-II
- XC9500 and XC9500XL

TRACE Input Files

Input to TRACE can be a mapped, a placed, or a placed and routed NCD file, along with an optional Physical Constraints File (PCF). The PCF is produced by the MAP program and based on timing constraints that you specify. Constraints can show such things as clock speed for input signals, the external timing relationship between two or more signals, absolute maximum delay on a design path, and general timing requirements for a class of pins.

- **NCD file** - A mapped, a placed, or a placed and routed design. The type of timing information TRACE provides depends on whether the design is unplaced (after MAP), placed only, or placed and routed.
- **PCF** - An optional, user-modifiable, physical constraints file produced by MAP. The PCF contains timing constraints used when TRACE performs a static timing analysis.

TRACE Output Files

TRACE outputs the following timing reports based on options specified on the command line:

- **TWR** - default timing report. The **-e** (error report) and **-v** (verbose report) options can be used to specify the type of timing report you want to produce: summary report (default), error report, or verbose report.
- **TWX** - XML timing report output by using the **-xml** option. This report is viewable with the Timing Analyzer GUI tool. The **-e** (error report) and **-v** (verbose report) options apply to the TWX file as well as the TWR file. See the [-xml \(XML Output File Name\)](#) section for details.

TRACE generates an optional STAMP timing model with the **-stamp** option. See the [-stamp \(Generates STAMP timing model files\)](#) section in this chapter for details.

Note For more information on the types of timing reports that TRACE generates, see the [TRACE Reports](#) section in this chapter.

TRACE Syntax

Use the following syntax to run TRACE from the command line:

```
trce [options] design [.ncd] [constraint [.pcf]]
```

options can be any number of the command line options listed in [TRACE Options](#). Options need not be listed in any particular order unless you are using the **-stamp (Generates STAMP timing model files)** option. Separate multiple options with spaces.

design specifies the name of the input design file. If you enter a file name with no extension, TRACE looks for an NCD file with the specified name.

constraint specifies the name of a Physical Constraints File (PCF). This file is used to define timing constraints for the design. If you do not specify a physical constraints file, TRACE looks for one with the same root name as the input design (NCD) file.

TRACE Options

This section describes the TRACE command line options.

- `-a` (Advanced Analysis)
- `-e` (Generate an Error Report)
- `-f` (Execute Commands File)
- `-fastpaths` (Report Fastest Paths)
- `-intstyle` (Integration Style)
- `-filter` (Filter File)
- `-l` (Limit Timing Report)
- `-n` (Report Paths Per Endpoint)
- `-nodatasheet` (No Data Sheet)
- `-noflight` (No Flight Delay)
- `-o` (Output Timing Report File Name)
- `-s` (Change Speed)
- `-stamp` (Generates STAMP timing model files)
- `-timegroups` (Create a Table of Timegroups)
- `-tsi` (Generate a Timing Specification Interaction Report)
- `-u` (Report Uncovered Paths)
- `-v` (Generate a Verbose Report)
- `-xml` (XML Output File Name)

-a (Advanced Analysis)

This option is only used if you are not supplying any timing constraints (from a PCF) to TRACE. The `-a` option writes out a timing report with the following information, which is supplied in place of the default information for the output timing report type (summary, error, or verbose).

- An analysis that enumerates all clocks and the required OFFSETs for each clock.
- An analysis of paths having only combinatorial logic, ordered by delay.

This option is similar to the “Auto-Generated Timing Constraints” option in Timing Analyzer. Both options will evaluate timing without user defined timing constraints.

Syntax

`-a`

Note An analysis of the paths associated with a particular clock signal includes a hold violation (race condition) check only for paths whose start and endpoints are registered on the same clock edge.

-e (Generate an Error Report)

This option causes the timing report to be an error report instead of the default summary report. See [Error Report](#) for a sample error report.

Syntax

`-e [limit]`

The report has the same root name as the input design and has a `.twr` extension.

The optional *limit* is an integer limit on the number of items reported for each timing constraint in the report file. The value of *limit* must be an integer from 0 to 32,000 inclusive. The default is 3.

-f (Execute Commands File)

This option executes the command line arguments in the specified *command_file*.

Syntax

-f *command_file*

For more information on the **-f** option, see [-f \(Execute Commands File\)](#) in the Introduction chapter.

-fastpaths (Report Fastest Paths)

This option is used to report the fastest paths of a design.

Syntax

-fastpaths

-filter (Filter File)

This option specifies a filter file, which contains settings to capture and filter messages produced by the program during execution.

Syntax

-filter [*filter_file*]

By default, the filter file name is *filter.filter*.

-intstyle (Integration Style)

This option limits screen output, based on the integration style that you are running, to warning and error messages only.

Syntax

-intstyle *ise|xflow|silent*

When using **-intstyle**, one of three modes must be specified:

- **-intstyle ise** indicates the program is being run as part of an integrated design environment.
- **-intstyle xflow** indicates the program is being run as part of an integrated batch flow.
- **-intstyle silent** limits screen output to warning and error messages only.

Note **-intstyle** is automatically invoked when running in an integrated environment such as Project Navigator or XFLOW.

-l (Limit Timing Report)

This option limits the number of items reported for each timing constraint in the report file. The limit value must be an integer from 0 to 2,000,000,000 (2 billion) inclusive. If a **-l** is not specified, the default value is 3.

Syntax

`-l limit`

Note The higher the limit value, the longer it takes to generate the timing report.

-n (Report Paths Per Endpoint)

This option reports paths per endpoint (the default is paths per constraint). You can limit the number of endpoints to speed up the report.

Syntax

`-n limit`

limit is the number of endpoints to report, and can be an integer from 0 to 2,000,000,000 (2 billion) inclusive.

Note The higher the limit value, the longer it takes to generate the timing report.

-nodatasheet (No Data Sheet)

This option does not include the datasheet section of a generated report.

Syntax

`-nodatasheet`

-noflight (No Flight Delay)

This option turns off package flight delay.

Syntax

`-noflight`

-o (Output Timing Report File Name)

This option specifies the name of the output timing report. The `.twr` extension is optional. If `-o` is not used, the output timing report has the same root name as the input design (NCD) file.

Syntax

`-o report [.twr]`

-s (Change Speed)

This option overrides the device speed contained in the input NCD file and instead performs an analysis for the device speed you specify. `-s` applies to whichever report type you produce in this TRACE run. The option allows you to see if faster or slower speed grades meet your timing requirements.

Syntax

`-s [speed]`

The device *speed* can be entered with or without the leading dash. For example, both `-s 3` and `-s -3` are valid entries.

Some architectures support minimum timing analysis. The command line syntax for minimum timing analysis is: `trace -s min`. Do not place a leading dash before `min`.

Note The `-s` option only changes the speed grade for which the timing analysis is performed; it does not save the new speed grade to the NCD file.

-stamp (Generates STAMP timing model files)

When you specify this option, TRACE generates a pair of STAMP timing model files (`stampfile.mod` and `stampfile.data`) that characterize the timing of a design.

Syntax

```
-stamp stampfile design.ncd
```

Note The stamp file entry must precede the NCD file entry on the command line.

The STAMP compiler can be used for any printed circuit board when performing static timing analysis.

Methods of running TRACE with the STAMP option to obtain a complete STAMP model report are:

- Run with advanced analysis using the `-a` option.
- Run using default analysis (with no constraint file and without advanced analysis).
- Construct constraints to cover all paths in the design.
- Run using the unconstrained path report (`-u` option) for constraints which only partially cover the design.

For either of the last two options, do not include TIGs in the PCF, as this can cause paths to be excluded from the model.

-timegroups (Create a Table of Timegroups)

This option tells TRACE to create a table of timegroups in the report. The command requires that you also specify `-v` ([Generate a Verbose Report](#)) or `-e` ([Generate an Error Report](#)).

Syntax

```
-timegroups
```

-tsi (Generate a Timing Specification Interaction Report)

This option tells TRACE to generate a Timing Specification Interaction (TSI) report (also known as the Constraint Interaction report). You can specify any name for the `.tsi` file. The file name is independent of the NCD and PCF names. You can also specify the NCD file and PCF from which the TSI report analyzes constraints.

Syntax

```
-tsi designfile.tsi designfile.ncd designfile.pcf
```

-u (Report Uncovered Paths)

This option reports delays for unconstrained paths optionally limited to the number of items specified by `<limit>`. The option adds an *unconstrained path analysis* constraint to your existing constraints. This constraint performs a default path enumeration on any paths for which no other constraints apply. The default path enumeration includes circuit paths to data and clock pins on sequential components and data pins on primary outputs.

Syntax

`-u limit`

The optional limit argument limits the number of unconstrained paths reported for each timing constraint in the report file. The value of *limit* must be an integer from 1 to 2,000,000,000 (2 billion) inclusive. If a limit is not specified, the default value is 3.

In the TRACE report, the following information is included for the unconstrained path analysis constraint.

- The minimum period for all of the uncovered paths to sequential components.
- The maximum delay for all of the uncovered paths containing only combinatorial logic.
- For a verbose report only, a listing of periods for sequential paths and delays for combinatorial paths. The list is ordered by delay value in descending order, and the number of entries in the list can be controlled by specifying a limit when you enter the `-v` (Generate a Verbose Report) command line option.

Note Register-to-register paths included in the unconstrained path report undergoes a hold violation (race condition) check only for paths whose start and endpoints are registered on the same clock edge.

-v (Generate a Verbose Report)

This option generates a verbose report. The report has the same root name as the input design with a `.twr` extension. You can assign a different root name for the report, but the extension must be `.twr`.

Syntax

`-v limit`

The optional *limit* used to limit the number of items reported for each timing constraint in the report file. The value of *limit* must be an integer from 1 to 32,000 inclusive. If a limit is not specified, the default value is 3.

-xml (XML Output File Name)

This option specifies the name of the output XML timing report (TWX) file. The `.twx` extension is optional.

Note The XML report is not formatted and can only be viewed with the Timing Analyzer GUI tool. For more information on Timing Analyzer, see the help provided with the tool.

Syntax

`-xml outfile[.twx]`

TRACE Command Line Examples

Example 1

```
trce design1.ncd group1.pcf
```

This command verifies the timing characteristics of the design named `design1.ncd`, generating a summary timing report. Timing constraints contained in the file `group1.pcf` are the timing constraints for the design. This generates the report file `design1.twr`.

Example 2

```
trce -v 10 design1.ncd group1.pcf -o output.twr
```

This command verifies the characteristics for the design named `design1.ncd`, using the timing constraints contained in the file `group1.pcf` and generates a verbose timing report. The verbose report file is called `output.twr`.

Example 3

```
trce -v 10 design1.ncd group1.pcf -xml output.twx
```

This command verifies the timing characteristics for the design named `design1.ncd`, using the timing constraints contained in the file `group1.pcf`, and generates a verbose timing report (TWR report and XML report). The verbose report file is named `design1.twr`, and the verbose XML report file is called `output.twx`.

Example 4

```
trce -e 3 design1.ncd timing.pcf
```

This command verifies the timing characteristics for the design named `design1.ncd` using the timing constraints contained in the timing file (`timing.pcf` in this example), and generates an error report. The error report lists the three worst errors for each constraint in `timing.pcf`. The error report file is named `design1.twr`.

TRACE Reports

Default output from TRACE is an ASCII formatted timing report file that provides information on how well the timing constraints for the design are met. The file is written into your working directory and has a `.twr` extension. The default name for the file is the root name of the input NCD file. You can designate a different root name for the file, but it must have a `.twr` extension. The `.twr` extension is assumed if not specified.

The timing report lists statistics on the design, any detected timing errors, and a number of warning conditions.

Timing errors show absolute or relative timing constraint violations, and include the following:

- **Path delay errors** - where the path delay exceeds the MAXIMUM DELAY constraint for a path.
- **Net delay errors** - where a net connection delay exceeds the MAXIMUM DELAY constraint for the net.
- **Offset errors** - where either the delay offset between an external clock and its associated data-in pin is insufficient to meet the timing requirements of the internal logic or the delay offset between an external clock and its associated data-out pin exceeds the timing requirements of the external logic.
- **Net skew errors** - where skew between net connections exceeds the maximum skew constraint for the net.

To correct timing errors, you may need to modify your design, modify the constraints, or rerun PAR.

Warnings point out potential problems, such as circuit cycles or a constraint that does not apply to any paths.

Three types of reports are available: summary, error, and verbose. You determine the report type by entering the corresponding TRACE command line option, or by selecting the type of report when using Timing Analyzer (see [TRACE Options](#)). Each type of report is described in [Reporting with TRACE](#).

In addition to the ASCII formatted timing report (TWR) file, you can generate an XML timing report (TWX) file with the `-xml` option. The XML report is not formatted and can only be viewed with Timing Analyzer.

Timing Verification with TRACE

TRACE checks the delays in the input NCD file against your timing constraints. If delays are exceeded, TRACE issues the appropriate timing error.

Note You should limit timing constraint values to 2 ms (milliseconds). Timing Constraint values more than 2 ms may result in bad values in the timing report.

Net Delay Constraints

When a MAXDELAY constraint is used, the delay for a constrained net is checked to ensure that the route delay is less than or equal to the NETDELAY constraint ($\text{routedelay} \leq \text{netdelayconstraint}$).

routedelay - is the signal delay between the driver pin and the load pins on a net. This is an estimated delay if the design is placed but not routed.

Any nets with delays that do not meet this condition generate timing errors in the timing report.

Net Skew Constraints

When using USELOWSKEWLINES or MAXSKEW constraints, signal skew on a net with multiple load pins is the difference between minimum and maximum load delays ($\text{signalskew} = (\text{maxdelay} - \text{mindelay})$).

- **mindelay** - is the maximum delay between the driver pin and a load pin.
- **maxdelay** - is the minimum delay between the driver pin and a load pin.

Note Register-to-register paths included in a MAXDELAY constraint report undergo a hold violation (race condition) check only for paths whose start and endpoints are registered on the same clock edge.

For constrained nets in the PCF, skew is checked to ensure that the SIGNALSKEW is less than or equal to the MAXSKEW constraint ($\text{signalskew} \leq \text{maxskewconstraint}$).

If the skew exceeds the maximum skew constraint, the timing report shows a skew error.

Path Delay Constraints

When a PERIOD constraint is used, the path delay equals the sum of logic (component) delay, route (wire) delay, and setup time (if any), minus clock skew (if any) ($\text{pathdelay} = \text{logicdelay} + \text{routedelay} + \text{setuptime} - \text{clockskew}$).

- **logic delay** - is the pin-to-pin delay through a component.
- **route delay** - is the signal delay between component pins in a path. This is an estimated delay if the design is placed but not routed.
- **setup time** - is the time that data must be present on an input pin before the arrival of the triggering edge of a clock signal (for clocked paths only).
- **clock skew** - is the difference between the amount of time the clock signal takes to reach the destination register and the amount of time the clock signal takes to reach the source register. Clock skew is discussed in the following section (for register-to-register clocked paths only).

The delay for constrained paths is checked to ensure that the path delay is less than or equal to the MAXPATHDELAY constraint ($\text{pathdelay} \leq \text{maxpathdelayconstraint}$).

Paths showing delays that do not meet this condition generate timing errors in the timing report.

Clock Skew and Setup Checking

Clock skew must be accounted for in register-to-register setup checks. For register-to-register paths, the data delay must reach the destination register within a single clock period. The timing analysis software ensures that any clock skew between the source and destination registers is accounted for in this check.

Note By default, the clock skew of all non-dedicated clocks, local clocks, and dedicated clocks is analyzed.

A setup check performed on register-to-register paths checks to make sure that $\text{Slack} = \text{constraint} + \text{Tsk} - (\text{Tpath} + \text{Tsu})$

- **constraint** - is the required time interval for the path, either specified explicitly by you with a FROM TO constraint, or derived from a PERIOD constraint.
- **Tpath** - is the summation of component and connection delays along the path.
- **Tsu (setup)** - is the setup requirement for the destination register.
- **Tsk (skew)** - is the difference between the arrival time for the destination register and the source register.
- **TSlack** - is the negative slack shows that a setup error may occur, because the data from the source register does not set up at the target register for a subsequent clock edge.

Clock Skew

The clock skew Tsk is the delay from the clock input (CLKIOB) to register D (TclkD) less the delay from the clock input (CLKIOB) to register S (TclkS). Negative skew relative to the destination reduces the amount of time available for the data path, while positive skew relative to the destination register increases the amount of time available for the data path.

Clock Passing Through Multiple Buffers

Because the total clock path delay determines the clock arrival times at the source register (TclkS) and the destination register (TclkD), this check still applies if the source and destination clocks originate at the same chip input but travel through different clock buffers and routing resources, as shown below.

When the source and destination clocks originate at different chip inputs, no obvious relationship between the two clock inputs exists for TRACE (because the software cannot determine the clock arrival time or phase information).

Clocks Originating at Different Device Inputs

For FROM TO constraints, TRACE assumes you have taken into account the external timing relationship between the chip inputs. TRACE assumes both clock inputs arrive simultaneously. The difference between the destination clock arrival time (TclkD) and the source clock arrival time (TclkS) does not account for any difference in the arrival times at the two different clock inputs to the chip, as shown below.

The clock skew Tsk is not accounted for in setup checks covered by PERIOD constraints where the clock paths to the source and destination registers originate at different clock inputs.

Reporting with TRACE

The timing report produced by TRACE is a formatted ASCII (TWR) file prepared for a particular design. It reports statistics on the design, a summary of timing warnings and errors, and optional detailed net and path delay reports. The ASCII (TWR) reports are formatted for viewing in a monospace (non-proportional) font. If the text editor you use for viewing the reports uses a proportional font, the columns in the reports do not line up correctly.

In addition to the TWR file, you can generate an XML timing report (TWX) file using the -xml option. The contents of the XML timing report are identical to the ASCII (TWR) timing report, although the XML report is not formatted and can only be viewed with the Timing Analyzer GUI tool.

This section describes the following types of timing reports generated by TRACE.

- **Summary Report** - Lists summary information, design statistics, and statistics for each constraint in the PCF.
- **Error Report** - Lists timing errors and associated net/path delay information.
- **Verbose Report** - Lists delay information for all nets and paths.

In each type of report, the header specifies the command line used to generate the report, the type of report, the input design name, the optional input physical constraints file name, speed file version, and device and speed data for the input NCD file. At the end of each report is a timing summary, which includes the following information:

- The number of timing errors found in the design. This information appears in all reports.
- A timing score, showing the total amount of error (in picoseconds) for all timing constraints in the design.
- The number of paths and nets covered by the constraints.
- The number of route delays and the percentage of connections covered by timing constraints.

Note The percentage of connections covered by timing constraints is given in a % coverage statistic. The statistic does not show the percentage of paths covered; it shows the percentage of connections covered. Even if you have entered constraints that cover all paths in the design, this percentage may be less than 100%, because some connections are never included for static timing analysis (for example, connections to the STARTUP component).

In the following sections, a description of each report is accompanied by a sample.

The following is a list of additional information on timing reports:

- For all timing reports, if you specify a physical constraints file that contains invalid data, a list of physical constraints file errors appears at the beginning of the report. These include errors in constraint syntax.
- In a timing report, a tilde (~) preceding a delay value shows that the delay value is approximate. Values with the tilde cannot be calculated exactly because of excessive delays, resistance, or capacitance on the net, that is, the path is too complex to calculate accurately.

The tilde (~) also means that the path may exceed the numerical value listed next to the tilde by as much as 20%. You can use the PENALIZE TILDE constraint to penalize these delays by a specified percentage (see the [Constraints Guide \(UG625\)](#) for a description of the PENALIZE TILDE constraint).

- In a timing report, an “e” preceding a delay value shows that the delay value is estimated because the path is not routed.
- TRACE detects when a path cycles (that is, when the path passes through a driving output more than once), and reports the total number of cycles detected in the design. When TRACE detects a cycle, it disables the cycle from being analyzed. If the cycle itself is made up of many possible routes, each route is disabled for all paths that converge through the cycle in question and the total number is included in the reported cycle tally.

A path is considered to cycle outside of the influence of other paths in the design. Thus, if a valid path follows a cycle from another path, but actually converges at an input and not a driving output, the path is not disabled and contains the elements of the cycle, which may be disabled on another path.

- Error counts reflect the number of path endpoints (register setup inputs, output pads) that fail to meet timing constraints, not the number of paths that fail the specification, as shown in the following figure.

Error reporting for failed timing constraints

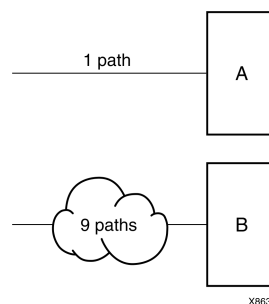

If an error is generated at the endpoints of A and B, the timing report would list one error for each of the endpoints.

Data Sheet Report

The Data Sheet report summarizes the external timing parameters for your design. Only inputs, outputs and clocks that have constraints appear in the Data Sheet report for verbose and error reports. Tables shown in the Data Sheet report depend on the type of timing paths present in the design, as well as the applied timing constraints. Unconstrained path analysis can be used with a constraints file to increase the coverage of the report to include paths not explicitly specified in the constraints file. In the absence of a physical constraints file (PCF), all I/O timing is analyzed and reported (less the effects of any default path tracing controls). The Data Sheet report includes the source and destination PAD names, and either the propagation delay between the source and destination or the setup and hold requirements for the source relative to the destination. TRACE now includes package flight times for certain packages.

There are four methods of running TRACE to obtain a complete Data Sheet report:

- Run with advanced analysis (-a)
- Run using default analysis (that is, with no constraints file and without advanced analysis)
- Construct constraints to cover all paths in the design
- Run using the unconstrained path report for constraints that only partially cover the design

Following are tables, including delay characteristics, that appear in the Data Sheet report:

- **Input Setup and Hold Times**

This table shows the setup and hold time for input signals with respect to an input clock at a source pad. It does not take into account any phase introduced by the DCM/DLL. If an input signal goes to two different destinations, the setup and hold are worst case for that signal. It might be the setup time for one destination and the hold time for another destination.
- **Output Clock to Out Times**

This table shows the clock-to-out signals with respect to an input clock at a source pad. It does not take into account any phase introduced by the DCM/DLL. If an output signal is a combinatorial result of different paths that are clocked by the same clock, the clock-to-out is the worst-case path.
- **Clock Table**

The clock table shows the relationship between different clocks. The Source Clock column shows all of the input clocks. The second column shows the delay between the rising edge of the source clock and the destination clock. The next column is the data delay between the falling edge of the source and the rising edge of the destination.

If there is one destination flip-flop for each source flip-flop the design is successful. If a source goes to different flip-flops of unrelated clocks, one flip-flop might get the data and another flip-flop might miss it because of different data delays.

You can quickly navigate to the Data Sheet report by clicking the corresponding item in the Hierarchical Report Browser.
- **External Setup and Hold Requirements**

Timing accounts for clock phase relationships and DCM phase shifting for all derivatives of a primary clock input. It reports separate data sheet setup and hold requirements for each primary input relative to all derivatives of a primary clock input covered by a timing constraint.

The maximum setup and hold times of device data inputs are listed relative to each clock input. When two or more paths from a data input exist relative to a device clock input, the worst-case setup and hold times are reported. One worst-case setup and hold time is reported for each data input and clock input combination in the design.

Following is an example of an external setup/hold requirement in the data sheet report:

```
Setup/Hold to clock ck1_i
-----+-----+
Source Pad | Setup to | Hold to |
          | clk (edge) | clk (edge) |
-----+-----+
start_i   | 2.816(R) | 0.000(R) |
-----+-----+
```

- User-Defined Phase Relationships

Timing reports separate setup and hold requirements for user-defined internal clocks in the data sheet report. User-defined external clock relationships are not reported separately.

- Clock-to-Clock Setup and Hold Requirements

Timing will not report separate setup and hold requirements for internal clocks.

- Guaranteed Setup and Hold

Guaranteed setup and hold requirements in the speed files will supersede any calculated setup and hold requirements made from detailed timing analysis. Timing will not include phase shifting, DCM duty cycle distortion, and jitter into guaranteed setup and hold requirements.

- Synchronous Propagation Delays

Timing accounts for clock phase relationships and DCM phase shifting for all primary outputs with a primary clock input source, and reports separate clock-to-output and maximum propagation delay ranges for each primary output covered by a timing constraint.

The maximum propagation delay from clock inputs to device data outputs are listed for each clock input. When two or more paths from a clock input to a data output exist, the worst-case propagation delay is reported. One worst-case propagation delay is reported for each data output and clock input combination.

Following is an example of clock-to-output propagation delays in the data sheet report:

```
Clock ck1_i to Pad
-----+-----+
Destination Pad | clk (edge) |
                | to PAD     |
-----+-----+
out1_o          | 16.691(R) |
-----+-----+
Clock to Setup on destination clock ck2_i
-----+-----+-----+-----+
Source Clock   | Src/Dest | Src/Dest | Src/Dest | Src/Dest |
                | Rise/Rise | Fall/Rise | Rise/Fall | Fall/Fall |
-----+-----+-----+-----+
ck2_i          | 12.647   |           |           |           |
ck1_i          | 10.241   |           |           |           |
-----+-----+-----+-----+
```

The maximum propagation delay from each device input to each device output is reported if a combinational path exists between the device input and output. When two or more paths exist between a device input and output, the worst-case propagation delay is reported. One worst-case propagation delay is reported for every input and output combination in the design.

Following are examples of input-to-output propagation delays:

Pad to Pad

Source Pad	Destination Pad	Delay
BSLOT0	D0S	37.534
BSLOT1	D09	37.876
BSLOT2	D10	34.627
BSLOT3	D11	37.214
CRESETN	VCASN0	51.846
CRESETN	VCASN1	51.846
CRESETN	VCASN2	49.776
CRESETN	VCASN3	52.408
CRESETN	VCASN4	52.314
CRESETN	VCASN5	52.314
CRESETN	VCASN6	51.357
CRESETN	VCASN7	52.527

- User-Defined Phase Relationships

Timing separates clock-to-output and maximum propagation delay ranges for user-defined internal clocks in the data sheet report. User-defined external clock relationships shall not be reported separately. They are broken out as separate external clocks.

Report Legend

The following table lists descriptions of what **X**, **R**, and **F** mean in the data sheet report.

Note Applies to FPGA designs only.

X	Indeterminate
R	Rising Edge
F	Falling Edge

Guaranteed Setup and Hold Reporting

Guaranteed setup and hold values obtained from speed files are used in the data sheet reports for IOB input registers when these registers are clocked by specific clock routing resources and when the guaranteed setup and hold times are available for a specified device and speed.

Specific clock routing resources are clock networks that originate at a clock IOB, use a clock buffer to reach a clock routing resource and route directly to IOB registers.

Guaranteed setup and hold times are also used for reporting of input OFFSET constraints.

The following figure and text describes the external setup and hold time relationships.

Guaranteed Setup and Hold

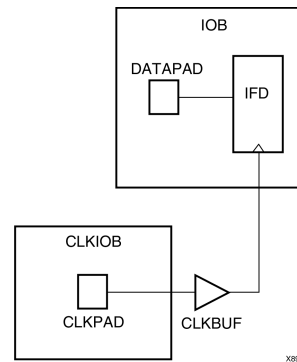

The pad CLKPAD of clock input component CLKIOB drives a global clock buffer CLKBUF, which in turn drives an input flip-flop IFD. The input flip-flop IFD clocks a data input driven from DATAPAD within the component IOB.

Setup Times

The external setup time is defined as the setup time of DATAPAD within IOB relative to CLKPAD within CLKIOB. When a guaranteed external setup time exists in the speed files for a particular DATAPAD and the CLKPAD pair and configuration, this number is used in timing reports. When no guaranteed external setup time exists in the speed files for a particular DATAPAD and CLKPAD pair, the external setup time is reported as the maximum path delay from DATAPAD to the IFD plus the maximum IFD setup time, less the minimum of maximum path delay(s) from the CLKPAD to the IFD.

Hold Times

The external hold time is defined as the hold time of DATAPAD within IOB relative to CLKPAD within CLKIOB. When a guaranteed external hold time exists in the speed files for a particular DATAPAD and the CLKPAD pair and configuration, this number is used in timing reports.

When no guaranteed external hold time exists in the speed files for a particular DATAPAD and CLKPAD pair, the external hold time is reported as the maximum path delay from CLKPAD to the IFD plus the maximum IFD hold time, less the minimum of maximum path delay(s) from the DATAPAD to the IFD.

Summary Report

The summary report includes the name of the design file being analyzed, the device speed and report level, followed by a statistical brief that includes the summary information and design statistics. The report also lists statistics for each constraint in the PCF, including the number of timing errors for each constraint.

A summary report is produced when you do not enter an -e (error report) or -v (verbose report) option on the TRACE command line.

Two sample summary reports are shown below. The first sample shows the results without having a physical constraints file. The second sample shows the results when a physical constraints file is specified.

If no physical constraints file exists or if there are no timing constraints in the PCF, TRACE performs default path and net enumeration to provide timing analysis statistics. Default path enumeration includes all circuit paths to data and clock pins on sequential components and all data pins on primary outputs. Default net enumeration includes all nets.

Summary Report (Without a Physical Constraints File Specified)

The following sample summary report represents the output of this TRACE command.

```
trce -o summary.twr ramb16_s1.ncd
```

The name of the report is summary.twr. No preference file is specified on the command line, and the directory containing the file ram16_s1.ncd did not contain a PCF called ramb16_s1.pcf.

```
-----
Xilinx TRACE
Copyright (c) 1995-2007 Xilinx, Inc. All rights reserved.
Design file: ramb16_s1.ncd
Device, speed: xc2v250,-6
Report level: summary report
-----
```

```
WARNING:Timing - No timing constraints found, doing default enumeration.
Asterisk (*) preceding a constraint indicates it was not met.
-----
```

Constraint	Requested	Actual	Logic Levels
Default period analysis		2.840ns	2
Default net enumeration		0.001ns	

All constraints were met.

Data Sheet report:

All values displayed in nanoseconds (ns)

Setup/Hold to clock clk

Source Pad	Setup to clk (edge)	Hold to clk (edge)
ad0	0.263(R)	0.555(R)
ad1	0.263(R)	0.555(R)
ad10	0.263(R)	0.555(R)
ad11	0.263(R)	0.555(R)
ad12	0.263(R)	0.555(R)
ad13	0.263(R)	0.555(R)
.		
.		
.		

-----+
Clock clk to Pad

Destination Pad	clk (edge) to PAD
d0	7.496(R)

Timing summary:

Timing errors: 0 Score: 0

Constraints cover 20 paths, 21 nets, and 21 connections (100.0% coverage)

Design statistics:

Minimum period: 2.840ns (Maximum frequency: 352.113MHz)

Maximum combinational path delay: 6.063ns

Maximum net delay: 0.001ns

Analysis completed Wed Mar 8 14:52:30 2000

Summary Report (With a Physical Constraints File Specified)

The following sample summary report represents the output of this TRACE command:

```
trce -o summary1.twr ramb16_s1.ncd clkperiod.pcf
```

The name of the report is summary1.twr. The timing analysis represented in the file were performed by referring to the constraints in the file clkperiod.pcf.

Xilinx TRACE

Copyright (c) 1995-2007 Xilinx, Inc. All rights reserved.

Design file: ramb16_s1.ncd

Physical constraint file: clkperiod.pcf

Device, speed: xc2v250,-6

Report level: summary report

Asterisk (*) preceding a constraint indicates it was not met.

Constraint	Requested	Actual	Logic Levels
TS01 = PERIOD TIMEGRP "clk" 10.0ns			
OFFSET = IN 3.0 ns AFTER COMP			
"clk" TIMEGRP	3.000ns	8.593ns	2
RP "rams"			
* TS02 = MAXDELAY FROM TIMEGRP			
"rams" TO TI	6.000ns	6.063ns	2
MEGRP "pads" 6.0 ns			

1 constraint not met.

Data Sheet report:

All values displayed in nanoseconds (ns)

Setup/Hold to clock clk

Source Pad	Setup to clk (edge)	Hold to clk (edge)
ad0	0.263(R)	0.555(R)
ad1	0.263(R)	0.555(R)
ad10	0.263(R)	0.555(R)

```

ad11          | 0.263(R) | 0.555(R) |
ad12          | 0.263(R) | 0.555(R) |
ad13          | 0.263(R) | 0.555(R) |
.
.
.
-----+-----+-----+
Clock clk to Pad
-----+-----+-----+
                | clk (edge) |
Destination Pad | to PAD |
-----+-----+-----+
d0              | 7.496(R) |
-----+-----+-----+

Timing summary:
-----

Timing errors: 1 Score: 63

Constraints cover 19 paths, 0 nets, and 21 connections (100.0% coverage)

Design statistics:
Maximum path delay from/to any node: 6.063ns
Maximum input arrival time after clock: 8.593ns

Analysis completed Wed Mar 8 14:54:31 2006
-----

```

When the physical constraints file includes timing constraints, the summary report lists the percentage of all design connections covered by timing constraints. If there are no timing constraints, the report shows 100% coverage. An asterisk (*) precedes constraints that fail.

Error Report

The error report lists timing errors and associated net and path delay information. Errors are ordered by constraint in the PCF and within constraints, by slack (the difference between the constraint and the analyzed value, with a negative slack showing an error condition). The maximum number of errors listed for each constraint is set by the limit you enter on the command line. The error report also contains a list of all time groups defined in the PCF and all of the members defined within each group.

The main body of the error report lists all timing constraints as they appear in the input PCF. If the constraint is met, the report states the number of items scored by TRACE, reports no timing errors detected, and issues a brief report line, showing important information (for example, the maximum delay for the particular constraint). If the constraint is not met, it gives the number of items scored by TRACE, the number of errors encountered, and a detailed breakdown of the error.

For errors in which the path delays are broken down into individual net and component delays, the report lists each physical resource and the logical resource from which the physical resource was generated.

As in the other three types of reports, descriptive material appears at the top. A timing summary always appears at the end of the reports.

The following sample error report (error.twr) represents the output generated with this TRACE command:

```
trce -e 3 ramb16_s1.ncd clkperiod.pcf -o error_report.twr
```

```

-----
Xilinx TRACE
Copyright (c) 1995-2007 Xilinx, Inc. All rights reserved.

trce -e 3 ramb16_sl.ncd clkperiod.pcf -o error_report.twr

Design file: ramb16_sl.ncd
Physical constraint file: clkperiod.pcf
Device,speed: xc2v250,-5 (ADVANCED 1.84 2001-05-09)
Report level: error report
-----

=====
Timing constraint: TS01 = PERIOD TIMEGRP "clk" 10.333ns ;

0 items analyzed, 0 timing errors detected.
-----

=====
Timing constraint: OFFSET = IN 3.0 ns AFTER COMP "clk" TIMEGRP "rams" ;

18 items analyzed, 0 timing errors detected.
Maximum allowable offset is 9.224ns.
-----

=====
Timing constraint: TS02 = MAXDELAY FROM TIMEGRP "rams" TO TIMEGRP "pads" 8.0 ns ;

1 item analyzed, 1 timing error detected.
Maximum delay is 8.587ns.
-----

Slack: -0.587ns (requirement - data path)
Source: RAMB16.A
Destination: d0
Requirement: 8.000ns
Data Path Delay: 8.587ns (Levels of Logic = 2)
Source Clock: CLK rising at 0.000ns

Data Path: RAMB16.A to d0
Location Delay type Delay(ns) Physical Resource
Logical Resource(s)
-----
RAMB16.D0A0 Tbcko 3.006 RAMB16
RAMB16.A
IOB.O1 net e 0.100 N$41
(fanout=1)
IOB.PAD Tioop 5.481 d0
I$22
d0
-----
Total 8.587ns (8.487ns logic, 0.100ns
.....route)
.....(98.8% logic, 1.2%
.....route)
-----

1 constraint not met.

```

Data Sheet report:

All values displayed in nanoseconds (ns)

Setup/Hold to clock clk

Source Pad	Setup to clk (edge)	Hold to clk (edge)
ad0	-0.013(R)	0.325(R)
ad1	-0.013(R)	0.325(R)
ad10	-0.013(R)	0.325(R)
ad11	-0.013(R)	0.325(R)
ad12	-0.013(R)	0.325(R)
ad13	-0.013(R)	0.325(R)
.		
.		
.		

Clock clk to Pad

Destination Pad	clk (edge) to PAD
d0	9.563(R)

Timing summary:

Timing errors: 1 Score: 587

Constraints cover 19 paths, 0 nets, and 21 connections (100.0% coverage)

Design statistics:

Maximum path delay from/to any node: 8.587ns

Maximum input arrival time after clock: 9.224ns

Analysis completed Mon Jun 03 17:47:21 2007

Verbose Report

The verbose report is similar to the error report and provides details on delays for all constrained paths and nets in the design. Entries are ordered by constraint in the PCF, which may differ from the UCF or NCF and, within constraints, by slack, with a negative slack showing an error condition. The maximum number of items listed for each constraint is set by the limit you enter on the command line.

Note The data sheet report and STAMP model display skew values on non-dedicated clock resources that do not display in the default period analysis of the normal verbose report. The data sheet report and STAMP model must include skew because skew affects the external timing model.

The verbose report also contains a list of all time groups defined in the PCF, and all of the members defined within each group.

The body of the verbose report enumerates each constraint as it appears in the input physical constraints file, the number of items scored by TRACE for that constraint, and the number of errors detected for the constraint. Each item is described, ordered by descending slack. A Report line for each item provides important information, such as the amount of delay on a net, fanout on each net, location if the logic has been placed, and by how much the constraint is met.

For path constraints, if there is an error, the report shows the amount by which the constraint is exceeded. For errors in which the path delays are broken down into individual net and component delays, the report lists each physical resource and the logical resource from which the physical resource was generated.

Verbose Report Example

The following sample verbose report (verbose.twr) represents the output generated with this TRACE command:

```
trce -v 1 ramb16_s1.ncd clkperiod.pcf -o verbose_report.twr
```

```
-----
Xilinx TRACE
```

```
Copyright (c) 1995-2007 Xilinx, Inc. All rights reserved.
```

```
trce -v 1 ramb16_s1.ncd clkperiod.pcf -o verbose_report.twr
```

```
Design file:                ramb16_s1.ncd
Physical constraint file:   clkperiod.pcf
Device,speed:              xc2v250,-5 (ADVANCED 1.84 2001-05-09)
Report level:              verbose report, limited to 1 item per constraint
-----
```

```
=====
Timing constraint: TS01 = PERIOD TIMEGRP "clk" 10.333ns ;
0 items analyzed, 0 timing errors detected.
-----
```

```
=====
Timing constraint: OFFSET = IN 3.0 ns AFTER COMP "clk" TIMEGRP "rams" ;
18 items analyzed, 0 timing errors detected.
Maximum allowable offset is 9.224ns.
-----
```

```
Slack:                      6.224ns (requirement - (data path - clock path
- clock arrival))
```

```
Source:                     ssr
Destination:                 RAMB16.A
Destination Clock:          CLK rising at 0.000ns
Requirement:                 7.333ns
Data Path Delay:             2.085ns (Levels of Logic = 2)
Clock Path Delay:            0.976ns (Levels of Logic = 2)
```

```
Data Path:  ssr to RAMB16.A
Location   Delay type   Delay(ns)
Physical Resource
```

```
Logical Resource(s)
```

```
-----
IOB.I      Tiopi
           0.551      ssr
                        ssr
                        I$36
RAM16.SSRA net          e 0.100      N$9
```

```

(fanout=1)
RAM16.CLKA Tbrck 1.434 RAMB16
RAMB16.A
-----
Total 2.085ns (1.985ns logic, 0.100ns
route)
(95.2% logic, 4.8%
route)

Clock Path: clk to RAMB16.A
Location Delay type Delay(ns) Physical Resource
Logical Resource(s)
-----
IOB.I Tiopi 0.551 clk
clk
clk/new_buffer
BUFGMUX.IO net e 0.100 clk/new_buffer
(fanout=1)
BUFGMUX.O Tgi0o 0.225 I$9
I$9
RAM16.CLKA net e 0.100 CLK
(fanout=1)
-----
Total 0.976ns (0.776ns logic, 0.200ns
route)
(79.5% logic, 20.5%
route)
-----

=====
Timing constraint: TS02 = MAXDELAY FROM TIMEGRP "rams" TO TIMEGRP "pads"
8.0 ns ;

1 item analyzed, 1 timing error detected.
Maximum delay is 8.587ns.
-----

Slack: -0.587ns (requirement - data path)
Source: RAMB16.A
Destination: d0
Requirement: 8.000ns
Data Path Delay: 8.587ns (Levels of Logic = 2)
Source Clock: CLK rising at 0.000ns
Data Path: RAMB16.A to d0
Location Delay type Delay(ns) Physical Resource
Logical Resource(s)
-----
RAMB16.DOA0 Tbcko 3.006 RAMB16
RAMB16.A
IOB.O1 net (fanout=1) e 0.100 N$41
IOB.PAD Tioop 5.481 d0
I$22
d0
-----
Total 8.587ns (8.487ns logic,
0.100ns route)
(98.8% logic, 1.2% route)
-----

1 constraint not met.

```

Data Sheet report:

All values displayed in nanoseconds (ns)

Setup/Hold to clock clk

Source Pad	Setup to clk (edge)	Hold to clk (edge)
ad0	-0.013(R)	0.325(R)
ad1	-0.013(R)	0.325(R)
ad10	-0.013(R)	0.325(R)
ad11	-0.013(R)	0.325(R)
.		
.		
.		

-----+-----+-----+
Clock clk to Pad

Destination Pad	clk (edge) to PAD
d0	9.563(R)

Timing summary:

Timing errors: 1 Score: 587

Constraints cover 19 paths, 0 nets, and 21 connections (100.0% coverage)

Design statistics:

Maximum path delay from/to any node: 8.587ns

Maximum input arrival time after clock: 9.224ns

Analysis completed Mon Jun 03 17:57:24 2007

OFFSET Constraints

OFFSET constraints define Input and Output timing constraints with respect to an initial time of 0ns.

The associated PERIOD constraint defines the initial clock edge. If the PERIOD constraint is defined with the attribute HIGH, the initial clock edge is the rising clock edge. If the attribute is LOW, the initial clock edge is the falling clock edge. This can be changed by using the RISING/FALLING keyword in the OFFSET constraint. The OFFSET constraint checks the setup time and hold time. For more information on constraints, see the [Constraints Guide \(UG625\)](#).

OFFSET IN Constraint Examples

This section describes in detail a specific example of an OFFSET IN constraint as shown in the Timing Constraints section of a timing analysis report. For clarification, the OFFSET IN constraint information is divided into the following parts:

- OFFSET IN Header
- OFFSET IN Path Details
- OFFSET IN Detailed Path Data
- OFFSET IN Detail Path Clock Path
- OFFSET IN with Phase Clock

OFFSET IN Header

The header includes the constraint, the number of items analyzed, and number of timing errors detected. Please see PERIOD Header for more information on items analyzed and timing errors.

```
=====
Timing constraint: OFFSET = IN 4 nS BEFORE COMP "wclk_in"  ;
113 items analyzed, 30 timing errors detected.
Minimum allowable offset is 4.468ns
```

```
-----
```

The minimum allowable offset is 4.468 ns. Because this is an OFFSET IN BEFORE, it means the data must be valid 4.468 ns before the initial edge of the clock. The PERIOD constraint was defined with the keyword HIGH, therefore the initial edge of the clock is the rising edge.

OFFSET IN Path Details

This path fails the constraint by 0.468 ns. The slack equation shows how the slack was calculated. In respect to the slack equation data delay increases the setup time while clock delay decreases the setup time. The clock arrival time is also taken into account. In this example, the clock arrival time is 0.000 ns; therefore, it does not affect the slack.

```
=====
Slack: -0.468ns (requirement - (data path - clock path - clock arrival + uncertainty))

Source:          wr_en1 (PAD)
Destination:     wr_addr[2] (FF)
Destination Clock: wclk rising at 0.000ns
Requirement:     4.000ns
Data Path Delay: 3.983ns (Levels of Logic = 2)
Clock Path Delay: -0.485ns (Levels of Logic = 3)
Clock Uncertainty: 0.000ns
Data Path:       wr_en1 to wr_addr[2]
-----
```

OFFSET IN Detailed Path Data

The first section is the data path. In the following case, the path starts at an IOB, goes through a look-up table (LUT) and is the clock enable pin of the destination flip-flop.

 Data Path: wr_en1 to wr_addr[2]

Location	Delay type	Delay(ns)	Logical Resource(s)
C4.I	Tiopi	0.825	wr_en1 wr_en1_ibuf
SLICE_X2Y9.G3	net (fanout=39)	1.887	wr_en1_c
SLICE_X2Y9.Y	Tilo	0.439	G_82
SLICE_X3Y11.CE	net (fanout=1)	0.592	G_82
SLICE_X3Y11.CLK	Tceck	0.240	wr_addr[2]
Total		3.983ns	(1.504ns logic, 2.479ns route) 37.8% logic, 62.2% route)

OFFSET IN Detail Path Clock Path

The second section is the clock path. In this example the clock starts at an IOB, goes to a DCM, comes out CLK0 of the DCM through a global buffer (BUFGHUX). It ends at a clock pin of a FF.

Tdcmينو is a calculated delay.

```

-----
Clock Path: wclk_in to wr_addr[2]

Location          Delay type          Delay(ns)          Logical Resource(s)
-----
D7.I              Tiopi              0.825             wclk_in
                  write_dcm/IBUFG

DCM_X0Y1.CLKIN    net (fanout=1)     0.798             write_dcm/IBUFG

DCM_X0Y1.CLK0     Tdcmينو           -4.297            write_dcm/CLKDLL

BUFGMUX3P.I0     net (fanout=1)     0.852             write_dcm/CLK0

BUFGMUX3P.O       Tgi0o              0.589             write_dcm/BUFG

SLICE_X3Y11.CLK  net (fanout=41)    0.748             wclk
-----

Total -0.485ns (-2.883ns logic, 2.398ns route)
-----

```

OFFSET In with Phase Shifted Clock

In the following example, the clock is the CLK90 output of the DCM. The clock arrival time is 2.5 ns. The rclk_90 rising at 2.500 ns. This number is calculated from the PERIOD on rclk_in which is 10ns in this example. The 2.5 ns affects the slack. Because the clock is delayed by 2.5 ns, the data has 2.5 ns longer to get to the destination.

If this path used the falling edge of the clock, the destination clock would say, falling at 00 ns 7.500 ns (2.5 for the phase and 5.0 for the clock edge). The minimum allowable offset can be negative because it is relative to the initial edge of the clock. A negative minimum allowable offset means the data can arrive after the initial edge of the clock. This often occurs when the destination clock is falling while the initial edge is defined as rising. This can also occur on clocks with phase shifting.

```

=====
Timing constraint: OFFSET = IN 4 nS BEFORE COMP "rclk_in" ;

2 items analyzed, 0 timing errors detected.

Minimum allowable offset is 1.316ns.

-----
Slack: 2.684ns (requirement - (data path - clock path - clock arrival + uncertainty))

Source:          wclk_in (PAD)

Destination:     ffl_reg (FF)

Destination Clock: rclk_90 rising at 2.500ns

```

```

Requirement:          4.000ns

Data Path Delay:     3.183ns (Levels of Logic = 5)

Clock Path Delay:   -0.633ns (Levels of Logic = 3)

Clock Uncertainty:  0.000ns

Data Path:          wclk_in to ffl_reg

Location            Delay type          Delay(ns)          Logical Resource(s)
-----
D7.I                Tiopi                0.825              wclk_in
                                                            write_dcm/IBUFG

DCM_X0Y1.CLKIN      net (fanout=1)       0.798              write_dcm/IBUFG

DCM_X0Y1.CLK0       Tdcmينو             -4.297             write_dcm/CLKDLL

BUFGMUX3P.I0        net (fanout=1)       0.852              write_dcm/CLK0

BUFGMUX3P.O         Tgi0o                0.589              write_dcm/BUFG

SLICE_X2Y11.G3      net (fanout=41)      1.884              wclk

SLICE_X2Y11.Y        Tilo                 0.439              un1_full_st

SLICE_X2Y11.F3      net (fanout=1)       0.035              un1_full_st

SLICE_X2Y11.X        Tilo                 0.439              full_st_i_0.G_4.G_4.G_4

K4.O1               net (fanout=3)       1.230              G_4

K4.OTCLK1           Tioock               0.389              ffl_reg
-----
Total 3.183ns (-1.616ns logic, 4.799ns route)

Clock Path: rclk_in to ffl_reg

Location            Delay type          Delay(ns)          Logical Resource(s)
-----
A8.I                Tiopi                0.825              rclk_in
                                                            read_ibufg

CM_X1Y1.CLKIN      net (fanout=1)       0.798              rclk_ibufg

CM_X1Y1.CLK90       Tdcmينو             -4.290             read_dcm

UFGMUX5P.I0        net (fanout=1)       0.852              rclk_90_dcm

BUFGMUX5P.O         Tgi0o                0.589              read90_bufg

```

```

4.OTCLK1          net (fanout=2)    0.593      rclk_90
-----
Total              -0.633ns    (-2.876ns logic, 2.243ns route)
-----

```

OFFSET OUT Constraint Examples

This section describes specific examples of an OFFSET OUT constraint, as shown in the Timing Constraints section of a timing report. For clarification, the OFFSET OUT constraint information is divided into the following parts:

- OFFSET OUT Header
- OFFSET OUT Path Details
- OFFSET OUT Detail Clock Path
- OFFSET OUT Detail Path Data

OFFSET OUT Header

The header includes the constraint, the number of items analyzed, and number of timing errors detected. See the PERIOD Header for more information on items analyzed and timing errors.

```

=====
Timing constraint: OFFSET = OUT 10 nS AFTER COMP "rclk_in"    ;
50 items analyzed, 0 timing errors detected.
Minimum allowable offset is 9.835ns.
-----

```

OFFSET OUT Path Details

The example path below passed the timing constraint by .533 ns. The slack equation shows how the slack was calculated. Data delay increases the clock to out time and clock delay also increases the clock to out time. The clock arrival time is also taken into account. In this example the clock arrival time is 0.000 ns; therefore, it does not affect the slack.

If the clock edge occurs at a different time, this value is also added to the clock to out time. If this example had the clock falling at 5.000 ns, 5.000 ns would be added to the slack equation because the initial edge of the corresponding PERIOD constraint is HIGH.

Note The clock falling at 5.000 ns is determined by how the PERIOD constraint is defined, for example PERIOD 10 HIGH 5.

```

=====
Slack: 0.533ns (requirement - (clock arrival + clock
path + data path + uncertainty))

Source:                wr_addr[2] (FF)

Destination:          efl (PAD)

Source Clock:          wclk rising at 0.000ns

Requirement:           10.000ns

Data Path Delay:       9.952ns (Levels of Logic = 4)

Clock Path Delay:      -0.485ns (Levels of Logic = 3)

Clock Uncertainty:     0.000ns
    
```

OFFSET OUT Detail Clock Path

In the following example, because the OFFSET OUT path starts with the clock, the clock path is shown first. The clock starts at an IOB, goes to a DCM, comes out CLK0 of the DCM through a global buffer. It ends at a clock pin of a FF.

The Tdcmino is a calculated delay.

Clock Path: rclk_in to rd_addr[2]

Location	Delay type	Delay(ns)	Logical Resource(s)
A8.I	Tiopi	0.825	rclk_in read_ibufg
DCM_X1Y1.CLKIN	net (fanout=1)	0.798	rclk_ibufg
DCM_X1Y1.CLK0	Tdcmino	-4.290	read_dcm
BUFGMUX7P.IO	net (fanout=1)	0.852	rclk_dcm
BUFGMUX7P.O	Tgi0o	0.589	read_bufg
SLICE_X4Y10.CLK	net (fanout=4)	0.738	rclk
Total		-0.488ns	(-2.876ns logic, 2.388ns route)

OFFSET OUT Detail Path Data

The second section is the data path. In this case, the path starts at an FF, goes through three look-up tables and ends at the IOB.

Data Path: rd_addr[2] to efl

Location	Delay type	Delay(ns)	Logical Resource(s)
SLICE_X4Y10.YQ	Tcko	0.568	rd_addr[2]
SLICE_X2Y10.F4	net (fanout=40)	0.681	rd_addr[2]
SLICE_X2Y10.X	Tilo	0.439	G_59
SLICE_X2Y10.G1	net (fanout=1)	0.286	G_59
SLICE_X2Y10.Y	Tilo	0.439	N_44_i
SLICE_X0Y0.F2	net (fanout=3)	1.348	N_44_i
SLICE_X0Y0.X	Tilo	0.439	empty_st_i_0
M4.O1	net (fanout=2)	0.474	empty_st_i_0
M4.PAD	Tioop	5.649	efl_obuf efl
Total		10.323ns (7.534ns logic, 2.789ns route)	(73.0% logic, 27.0% route)

PERIOD Constraints

A PERIOD constraint identifies all paths between all sequential elements controlled by the given clock signal name. For more information on constraints, see the [Constraints Guide \(UG625\)](#).

This section provides examples and details of the PERIOD constraints shown in the Timing Constraints section of a timing analysis report. For clarification, PERIOD constraint information is divided into the following parts:

- PERIOD Header
- PERIOD Path
- PERIOD Path Details
- PERIOD Constraint with PHASE

PERIOD Header

The following example is of a constraint generated using NGDBuild during the translate step in the design flow. A new timespec (constraint) name was created. In this example it is TS_write_dcm_CLK0. Write_dcm is the instantiated name of the DCM. CLK0 is the output clock. The timegroup created for the PERIOD constraint is write_dcm_CLK0. The constraint is related to TS_wclk. In this example, the PERIOD constraint is the same as the original constraint because the original constraint is multiplied by 1 and there is not a phase offset. Because TS_wclk is defined to have a Period of 12 ns, this constraint has a Period of 12 ns.

In this constraint, 296 items are analyzed. An item is a path or a net. Because this constraint deals with paths, an item refers to a unique path. If the design has unique paths to the same endpoints, this is counted as two paths. If this constraint were a MAXDELAY or a net-based constraint, items refer to nets. The number of timing errors refers to the number of endpoints that do not meet the timing requirement, and the number of endpoints with hold violations. If the number of hold violations is not shown, there are no hold violations for this constraint. If there are two or more paths to the same endpoint, it is considered one timing error. If this is the situation, the report shows two or more detailed paths; one for each path to the same endpoint.

The next line reports the minimum Period for this constraint, which is how fast this clock runs.

```
=====
Timing constraint: TS_write_dcm_CLK0 = PERIOD TIMEGRP "write_dcm_CLK0" TS_wclk *
1.000000 HIGH
50.000 % ;
296 items analyzed, 0 timing errors detected.
Minimum period is 3.825ns.
-----
```

PERIOD Path

The detail path section shows all of the details for each path in the analyzed timing constraint. The most important thing it does is identify if the path meets the timing requirement. This information appears on the first line and is defined as the Slack. If the slack number is positive, the path meets timing constraint by the slack amount. If the slack number is negative, the path fails the timing constraint by the slack amount. Next to the slack number is the equation used for calculating the slack. The requirement is the time constraint number. In this case, it is 12 ns. Because that is the time for the original timespec TS_wclk. The data path delay is 3.811 ns and the clock skew is negative 0.014 ns. $(12 - (3.811 - 0.014) = 8.203)$. The detail paths are sorted by slack. The path with the least amount of slack is the first path shown in the Timing Constraints section.

The Source is the starting point of the path. Following the source name is the type of component. In this case the component is a flip-flop (FF). The FF group also contains the SRL16. Other components are RAM (Distributed RAM vs. BlockRAM), PAD, LATCH, HSIO (High Speed I/O such as the Gigabit Transceivers) MULT (Multipliers), CPU (PowerPC® processor), and others. In Timing Analyzer, for FPGA designs the Source is a hot-link for cross probing.

The Destination is the ending point of the path. See the above description of the Source for more information about Destination component types and cross probing.

The Requirement is a calculated number based on the time constraint and the time of the clock edges. The source and destination clock of this path are the same so the entire requirement is used. If the source or destination clock was a related clock, the new requirement would be the time difference between the clock edges. If the source and destination clocks are the same clock but different edges, the new requirement would be half the original period constraint.

The Data Path Delay is the delay of the data path from the source to the destination. The levels of logic are the number of LUTs that carry logic between the source and destination. It does not include the clock-to-out or the setup at the destination. If there was a LUT in the same slice of the destination, that counts as a level of logic. For this path, there is no logic between the source and destination therefore the level of logic is 0.

The Clock Skew is the difference between the time a clock signal arrives at the source flip-flop in a path and the time it arrives at the destination flip-flop. If Clock Skew is not checked it will not be reported.

The Source Clock or the Destination Clock report the clock name at the source or destination point. It also includes if the clock edge is the rising or falling edge and the time that the edge occurs. If clock phase is introduced by the DCM/DLL, it would show up in the arrival time of the clock. This includes coarse phase (CLK90, CLK180, or CLK270) and fine phase introduced by Fixed Phase Shift or the initial phase of Variable Phase Shift

The Clock Uncertainty for an OFFSET constraint might be different than the clock uncertainty on a PERIOD constraint for the same clock. The OFFSET constraint only looks at one clock edge in the equation but the PERIOD constraints takes into account the uncertainty on the clock at the source registers and the uncertainty on the clock at the destination register therefore there are two clock edges in the equation.

```
-----
Slack: 8.175ns (requirement - (data path - clock skew + uncertainty))
Source: wr_addr[0] (FF)
Destination: fifo_ram/BU5/SP (RAM)
Requirement: 12.000ns
Data Path Delay: 3.811ns (Levels of Logic = 1)
clock skew: -0.014ns
Source Clock: wclk rising at 0.000ns
Destination Clock: wclk rising at 12.000ns
Clock Uncertainty: 0.000ns
-----
```

PERIOD Path Details

The first line is a link to the Constraint Improvement Wizard (CIW). The CIW gives suggestions for resolving timing constraint issues if it is a failing path. The data path section shows all the delays for each component and net in the path. The first column is the Location of the component in the FPGA. It is turned off by default in TWX reports. The next column is the Delay Type. If it is a net, the fanout is shown. The Delay names correspond with the datasheet. For an explanation of the delay names, click on a delay name for a description page to appear.

The next columns are the Physical Resource and Logical Resource names. The Physical name is the name of the component after mapping. This name is generated by the Map process. It is turned off by default in TWX reports. The logical name is the name in the design file. This is typically created by the synthesis tool or schematic capture program.

At the end of the path is the total amount of the delay followed by a breakdown of logic vs. routing. This is useful information for debugging a timing failure. For more information see Timing Improvement Wizard for suggestions on how to fix a timing issues.

```
-----
Constraints Improvement Wizard
Data Path: wr_addr[0] to fifo_ram/BU5/SP
Location Delay type Delay(ns) Logical Resource(s)
-----
SLICE_X2Y4.YQ Tcko 0.568 wr_addr[0]
SLICE_X6Y8.WF1 net (fanout=112) 2.721 wr_addr[0]
SLICE_X6Y8.CLK Tas 0.522 fifo_ram/BU5/SP
-----
Total 3.811ns (1.090ns logic, 2.721ns route)
(28.6% logic, 71.4% route)
-----
```

PERIOD Constraint with PHASE

This is a PERIOD constraint for a clock with Phase. It is a constraint created by the Translate (NGDBuild) step. It is related back to the TS_rclk constraint with a PHASE of 2.5 ns added. The clock is the CLK90 output of the DCM. Since the PERIOD constraint is 10 ns the clock phase from the CLK90 output is 2.5 ns, one-fourth of the original constraint. This is defined using the PHASE keyword.

```
Timing constraint: TS_rclk_90_dcm = PERIOD TIMEGRP "rclk_90_dcm"
    TS_rclk * 1.000000 PHASE + 2.500
nS HIGH 50.000 % ;
6 items analyzed, 1 timing error detected.
Minimum period is 21.484ns.
-----
```

PERIOD Path with Phase

This is similar to the PERIOD constraint (without PHASE). The difference for this path is the source and destination clock. The destination clock defines which PERIOD constraint the path uses. Because the destination clock is the rclk_90, this path is in the TS_rclk90_dcm PERIOD and not the TS_rclk PERIOD constraint.

Notice the Requirement is now 2.5 ns and not 10 ns. This is the amount of time between the source clock (rising at 0ns) and the destination clock (rising at 2.5 ns).

Because the slack is negative, this path fails the constraint. In the Hierarchical Report Browser, this failing path is displayed in red.

```
-----
Slack:    -2.871ns (requirement - (data path - clock skew + uncertainty))
Source: rd_addr[1] (FF)
Destination: ffl_reg (FF)
Requirement: 2.500ns
Data Path Delay: 5.224ns (Levels of Logic = 2)
Clock Skew: -0.147ns
Source Clock: rclk rising at 0.000ns
Destination Clock: rclk_90 rising at 2.500ns
Clock Uncertainty: 0.000ns
Data Path: rd_addr[1] to ffl_reg
Location Delay type Delay(ns) Logical Resource(s)
-----
SLICE_X4Y19.XQ Tcko 0.568 rd_addr[1]
SLICE_X2Y9.F3 net (fanout=40) 1.700 rd_addr[1]
SLICE_X2Y9.X Tilo 0.439 full_st_i_0.G_4.G_4.G_3_10
SLICE_X2Y11.F2 net (fanout=1) 0.459 G_3_10
SLICE_X2Y11.X Tilo 0.439 full_st_i_0.G_4.G_4.G_4
K4.O1 net (fanout=3) 1.230 G_4
K4.OTCLK1 Tioock 0.389 ffl_reg
-----
Total 5.224ns (1.835ns logic, 3.389ns route)
(35.1% logic, 64.9% route)
-----
```

Minimum Period Statistics

The Timing takes into account paths that are in a FROM:TO constraints but the minimum period value does not account for the extra time allowed by multi-cycle constraints.

An example of how the Minimum Period Statistics are calculated. This number is calculated assuming all paths are single cycle.

```
-----
Design statistics:
Minimum period: 30.008ns (Maximum frequency: 33.324MHz)
Maximum combinational path delay: 42.187ns
Maximum path delay from/to any node: 31.026ns
Minimum input arrival time before clock: 12.680ns
Maximum output required time before clock: 43.970ns
-----
```

Halting TRACE

To halt TRACE, press **Ctrl-C** (on Linux) or **Ctrl-BREAK** (on Windows). On Linux, make sure the active window is the window from which you invoked TRACE. The program prompts you to confirm the interrupt. Some files may be left when TRACE is halted (for example, a TRACE report file or a physical constraints file), but these files may be discarded because they represent an incomplete operation.

Speedprint

This chapter describes Speedprint.

Speedprint Overview

Speedprint is a Xilinx® command line tool that provides general information about block delay values. To view precise values for a particular path through a block, see a trace report showing that path.

Speedprint Flow

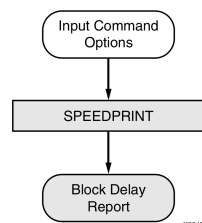

Speedprint Device Support

This program is compatible with the following device families:

- 7 series
- Spartan®-3, Spartan-3A, Spartan-3E, and Spartan-6
- Virtex®-4, Virtex-5, and Virtex-6

Speedprint File Types

There are no Speedprint file types. The report output is written to standard output (**stdout**). To save Speedprint output, redirect the output as shown in below.

```
speedprint 5vlx30 > report1.txt
```

Speedprint Example Report One: speedprint 5vlx30

This report is for a normal device with no special options. This report is for worst case temperature and voltage in the default speed grade.

Family virtex5, Device xc5vlx30

Block delay report for device: 5vlx30, speed grade: -3, Stepping Level: 0

Version identification for speed file is: PRODUCTION 1.58_a 2007-10-05

Speed grades available for this device: -MIN -3 -2 -1

This report prepared for speed grade of -3 using a junction temperature of 85.000000 degrees C and a supply voltage of 0.950000 volts.

Operating condition ranges for this device:
Voltage 0.950000 to 1.050000 volts
Temperature 0.000000 to 85.000000 degrees Celsius

This speed grade does not support reporting delays for specific voltage and temperature conditions.

Default System Jitter for this device is 50.00 picoseconds.

Setup/Hold Calculation Support

Delay Adjustment Factors:

Note: This speed file does not contain any delay adjustment factors.
The following list of packages have individual package flight times for each pin on the device:

ff324
ff676

No external setup and hold delays

This report is intended to present the effect of different speed grades and voltage/temperature adjustments on block delays.
For specific situations use the Timing Analyzer report instead.

Delays are reported in picoseconds.

When a block is placed in a site normally used for another type of block, for example, an IOB placed in a Clock IOB site, small variations in delay may occur which are not included in this report.

NOTE: The delay name is followed by a pair of values representing a relative minimum delay value and its corresponding maximum value. If a range of values exists for a delay name, then the smallest pair and the largest pair are reported.

BUFG
Tbgcko_0 173.00 / 188.00

BUFGCTRL
Tbccck_CE 265.00 / 265.00
Tbccck_S 265.00 / 265.00
Tbccckc_CE 0.00 / 0.00
Tbccckc_S 0.00 / 0.00
Tbcccko_0 173.00 / 188.00

BUFIO
Tbufiocko_0 594.00 / 1080.00

.
.

Speedprint Example Report Two: speedprint -help

This report is Help output showing the various options.

```
Usage: speedprint [-s <sgrade>] [-t <temp>] [-v <volt>] [-stepping <level>] [-intstyle <style>] <device>
You must specify a device whose delays you want to see.
For example, speedprint 2v250e.
Options and arguments are:
-s <sgrade> Desired speed grade. Default is used if not specified.
Use -s min for the absolute minimum delay values.
-t <temp> Junction temperature of device. Default is worst case.
-v <volts> Supply voltage. Default is worst case.
-stepping <level> Stepping Level. Default is production shipping.
-intstyle <style> Integration flow. ise|flow|silent.
```

Speedprint Example Report Three: speedprint xa3s200a -s 4Q -v 1.2 -t 75

Family aspartan3a, Device xa3s200a

Block delay report for device: xa3s200a, speed grade: -4Q

Version identification for speed file is: PRODUCTION 1.39_a 2007-10-05

Speed grades available for this device: -MIN -4 -4Q

This report prepared for speed grade of -4Q using a junction temperature of 75.000000 degrees C and a supply voltage of 1.200000 volts.

Operating condition ranges for this device:
Voltage 1.140000 to 1.260000 volts
Temperature -40.000000 to 125.000000 degrees Celsius

This speed grade supports reporting delays for specific voltage and temperature conditions over the above operating condition ranges.

Setup/Hold Calculation Support

Delay Adjustment Factors:

Note: This speed file does not contain any delay adjustment factors.

No external setup and hold delays

This report is intended to present the effect of different speed grades and voltage/temperature adjustments on block delays. For specific situations use the Timing Analyzer report instead.

Delays are reported in picoseconds.

When a block is placed in a site normally used for another type of block, for example, an IOB placed in a Clock IOB site, small variations in delay may occur which are not included in this report.

NOTE: The delay name is followed by a pair of values representing a relative minimum delay value and its corresponding maximum value. If a range of values exists for a delay name, then the smallest pair and the largest pair are reported.

BUFGMUX

Tgi0o 195.59 / 217.32
Tgi0s 0.00 / 0.00
Tgi1o 195.59 / 217.32
Tgils 0.00 / 0.00
Tgsi0 613.60 / 613.60
Tgsi1 613.60 / 613.60

DCM

Tdmckk_PSEN 16.72 / 16.72
Tdmckk_PSINCDEC 16.72 / 16.72
Tdmckc_PSEN 0.00 / 0.00
Tdmckc_PSINCDEC 0.00 / 0.00
Tdmcko_CLK 14.16 / 16.72
Tdmcko_CLK2X 14.16 / 16.72
Tdmcko_CLKDV 14.16 / 16.72
Tdmcko_CLKFX 14.16 / 16.72
Tdmcko_CONCUR 14.16 / 16.72
Tdmcko_LOCKED 14.16 / 16.72
Tdmcko_PSDONE 14.16 / 16.72
Tdmcko_STATUS 14.16 / 16.72

.
.

.

Speedprint Command Line Syntax

The Speedprint command line syntax is:

```
speedprint [options] [device_name]
```

options can be any number of the options listed in [Speedprint Command Line Options](#). Enter options in any order, preceded them with a dash (minus sign on the keyboard) and separate them with spaces.

device_name is the device for which you want to print information.

Speedprint Example Commands

Command	Description
speedprint	Prints usage message
speedprint 2v80	Uses the default speed grade
speedprint -s 5 2v80	Displays block delays for speed grade -5
speedprint -2v50e -v 1.9 -t 40	Uses default speed grade at 1.9 volts and 40 degrees C
speedprint v50e -min	Displays data for the minimum speed grade

Speedprint Command Line Options

This section describes the Speedprint command line options.

- [-intstyle \(Integration Style\)](#)
- [-min \(Display Minimum Speed Data\)](#)
- [-s \(Speed Grade\)](#)
- [-stepping \(Stepping\)](#)
- [-t \(Specify Temperature\)](#)
- [-v \(Specify Voltage\)](#)

-intstyle (Integration Style)

This option limits screen output, based on the integration style that you are running, to warning and error messages only.

Syntax

```
-intstyle ise|xflow|silent
```

When using **-intstyle**, one of three modes must be specified:

- **-intstyle ise** indicates the program is being run as part of an integrated design environment.
- **-intstyle xflow** indicates the program is being run as part of an integrated batch flow.
- **-intstyle silent** limits screen output to warning and error messages only.

Note **-intstyle** is automatically invoked when running in an integrated environment such as Project Navigator or XFLOW.

Speedprint -min (Display Minimum Speed Data)

This option displays minimum speed data for a device. The **speedprint -min** option overrides the **speedprint -s** option if both are used.

Syntax

`-min`

-s (Speed Grade)

This option displays data for the specified speed grade. If the `-s` option is omitted, delay data for the default, which is the fastest speed grade, is displayed.

Syntax

`-s [speed_grade]`

Caution! Do not use leading dashes on speed grades. For example, the syntax `speedprint 5v1x30 -s 3` is proper; the syntax `speedprint 5v1x30 -s -3` is not.

-stepping (Stepping)

This option causes Speedprint to report delays for the specified stepping. For each part, there is a default stepping. If the `-stepping` command line option is omitted, Speedprint reports delays for the default stepping. Steppings do not necessarily affect delays, but may do so.

Syntax

`-stepping stepping_value`

Examples

```
speedprint -stepping 0
speedprint -stepping ES
```

-t (Specify Temperature)

This option specifies the operating die temperature in degrees Celsius. If this option is omitted, Speedprint uses the worst-case temperature.

Syntax

`-t temperature`

Examples

```
speedprint -t 85
speedprint -t -20
```

-v (Specify Voltage)

The `speedprint` (Specify Voltage) command line option specifies the operating voltage of the device in volts. If this option is omitted, Speedprint uses the worst-case voltage.

Syntax

`-v voltage`

Examples

```
speedprint -v 1.2
speedprint -v 5
```

BitGen

This chapter describes BitGen.

BitGen Overview

BitGen is a Xilinx® command line tool that generates a bitstream for Xilinx device configuration. After the design is completely routed, you configure the device using files generated by BitGen. BitGen takes a fully routed Native Circuit Description (NCD) file as input and produces a configuration bitstream (BIT) file as output. A BIT file is a binary file with a .bit extension.

The BIT file contains the configuration information from the NCD file. The NCD file defines the internal logic and interconnections of the FPGA device, together with device-specific information from other files associated with the target device. The binary data in the BIT file is then downloaded into the memory cells of the FPGA device, or used to create a PROM file. For more information, see the [PROMGen](#) chapter.

Note If you have a BMM file as an input to NGDBuild then BitGen will update this BMM file with the BRAM locations (assigned during PAR) and generate an updated back annotated `_bd.bmm` file.

BitGen creates `_bd.bmm` file when the NCD it is given has BMM information embedded in it and it is given an ELF/MEM file as input using the `-bd` switch.

Design Flow

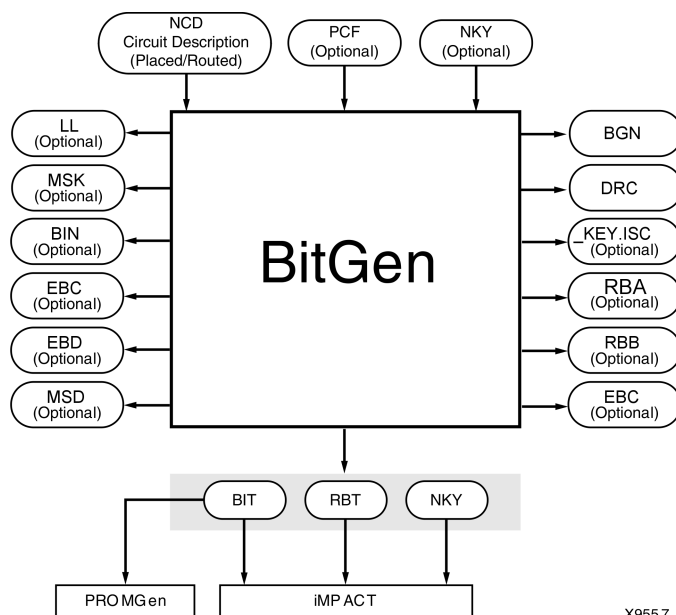

X9557

BitGen Device Support

This program is compatible with the following device families:

- 7 series
- Spartan®-3, Spartan-3A, Spartan-3E, and Spartan-6
- Virtex®-4, Virtex-5, and Virtex-6

BitGen Input Files

BitGen uses the input files shown below.

File	Type	Acronym	Devices	Extension	Description
Native Circuit Description	Input	NCD	FPGA	.ncd	A physical description of the design mapped, placed and routed in the target device. The NCD file must be fully routed.
Physical Constraints File	Input	PCF	FPGA	.pcf	An optional user-modifiable ASCII Physical Constraints File
Encryption Key	Encryption	NKY	FPGA	.nky	An optional encryption key file. For more information on encryption, see http://www.xilinx.com/products/ipcenter/DES.htm .

BitGen Output Files

BitGen generates the output files shown below.

File Type	Format	File Contents	Notes	Produced
.bgn	ASCII	Log information for the BitGen run, including command line options, errors, and warnings.		Always
.bin	Binary	Configuration data only	The BIN file has no header like the BIT file.	When bitgen -g Binary:Yes is specified.
.bit	Binary	Proprietary header information; configuration data.	Meant for input to other Xilinx tools, such as PROMGen and iMPACT.	Always, unless bitgen -j is specified.
.drc	ASCII	Log information or Design Rules Checker, including errors and warnings.		Always, unless bitgen -d is specified.
.ebc	ASCII	Configuration data as would be read back during SEU readback, including pad frames. The EBC file has no commands in it, and is not the same as the BIT file.		When bitgen -g EssentialBits:Yes is specified.

File Type	Format	File Contents	Notes	Produced
.ebd	ASCII	Contains mask data that indicates which bits of the EBC file are essential to the circuitry of the design. The EBD file is the same size as the EBC file; the bits have one-to-one correspondence.	If a mask bit is 0, BitGen is declaring that the corresponding configuration bit is non-essential to the circuitry of the design. BitGen classifies bits as non-essential only if it is certain the bits have no association with the circuitry of the design. If a mask bit is 1, BitGen is declaring that the corresponding configuration bit is essential to the circuitry of the design.	When bitgen -g EssentialBits:Yes is specified.
.isc	ASCII	Configuration data in IEEE 1532 format.	The IEEE1532 format is not supported for all architectures.	When bitgen -g IEEE1532:Yes is specified.
.ll	ASCII	Information on each of the nodes in the design that can be captured for readback. The file contains the absolute bit position in the readback stream, frame address, frame offset, logic resource used, and name of the component in the design.		When bitgen -l is specified.
.msd	ASCII	Mask information for verification only, including pad words and frames.	No commands are included.	When bitgen -g Readback is specified.
.msk	Binary	The same configuration commands as a BIT file, but which has mask data where the configuration data is.	If a mask bit is 0, that bit should be verified against the bitstream data. If a mask bit is 1, that bit should not be verified.	When bitgen -m is specified.
.nky	ASCII	Key information when encryption is desired.	This file is used as an input to iMPACT to program the keys. This data should NOT be used to configure the device.	When bitgen -g Encrypt:Yes is specified.
<outname>_key.isc	ASCII	Data for programming the encryption keys in IEEE 1532 format.	The IEEE1532 format is not supported for all architectures.	When bitgen -g IEEE1532:Yes and bitgen -g Encrypt:Yes are set.
.rba	ASCII	Readback commands, rather than configuration commands, and expected readback data where the configuration data would normally be.		To produce the .rba file, bitgen -b must be used when bitgen -g Readback is specified.
.rbb	Binary	Readback commands, rather than configuration commands, and expected readback data where the configuration data would normally be.	The same as the .rba file, but in binary format	When bitgen -g Readback is specified.

File Type	Format	File Contents	Notes	Produced
.rbd	ASCII	Expected readback data only, including pad words and frames. No commands are included.		When bitgen -g Readback is specified.
.rbt	ASCII	Same information as the BIT file.	The same as the BIT file, but in ASCII format.	When bitgen -b is specified.

For more information on encryption, see the Answers Database at <http://www.xilinx.com/support>.

BitGen Command Line Syntax

The BitGen command line syntax is:

```
bitgen [options] infile[.ncd] [outfile] [pcf_file.pcf]
```

- *options* are one or more of the options listed in [BitGen Command Line Options](#). Enter options in any order, preceded them with a dash (minus sign on the keyboard) and separate them with spaces.
- *infile* is the name of the Native Circuit Description (NCD) design for which you want to create the bitstream.
- *outfile* is the name of the output file.
 - If you do not specify an output file name, BitGen creates a Bitstream (BIT) file in your input file directory.
 - If you specify any of the options shown in BitGen Options and Output Files, BitGen creates the corresponding file in addition to BIT file.
 - If you do not specify an extension, BitGen appends the correct extension for the specified option.
 - A report file containing all BitGen output is automatically created under the same directory as the output file.
 - The report file has the same root name as the output file and a `.bgn` extension.
- *pcf_file* is the name of a Physical Constraints File (PCF). BitGen uses the PCF to interpret CONFIG constraints. CONFIG constraints do the following:
 - Control bitstream options
 - Override default behavior
 - Can be overridden by configuration options

BitGen automatically reads the PCF by default.

- If the PCF is the second file specified on the command line, it must have a `.pcf` extension.
- If the PCF is the third file specified, the extension is optional. In that case, `.pcf` is assumed.

If the PCF is specified, it must exist. Otherwise, the input design name with a `.pcf` extension is assumed.

BitGen Command Line Options

This section describes the BitGen command line options.

- `-b` (Create Rawbits File)
- `-bd` (Update Block Rams)
- `-d` (Do Not Run DRC)
- `-f` (Execute Commands File)
- `-g` (Set Configuration)
- `-intstyle` (Integration Style)
- `-j` (No BIT File)
- `-l` (Create a Logic Allocation File)
- `-m` (Generate a Mask File)
- `-r` (Create a Partial Bit File)
- `-w` (Overwrite Existing Output File)

-b (Create Rawbits File)

This option creates a rawbits (*file_name.rbt*) file.

Syntax

`-b`

Combining `bitgen -g Readback` with `bitgen -b` also generates an ASCII readback command file (*file_name.rba*).

The rawbits file consists of ASCII ones and zeros representing the data in the bitstream file. If you are using a microprocessor to configure a single FPGA device, you can include the rawbits file in the source code as a text file to represent the configuration data. The sequence of characters in the rawbits file is the same as the sequence of bits written into the FPGA device.

-bd (Update Block Rams)

This option updates the bitstream with the block ram content from the specified ELF or MEM file.

Syntax

`-bd file_name { .elf | .mem }`

-d (Do Not Run DRC)

This option instructs BitGen not to run a design rule check (DRC).

Syntax

-d

Without the **-d** option, BitGen runs a design rule check and saves the results in two output files:

- BitGen report file (`file_name.bgn`)
- DRC file (`file_name.drc`).

If you enter **bitgen -d**:

- No DRC information appears in the report file
- No DRC file is produced

Running DRC before a bitstream is produced detects any errors that could cause the FPGA device to malfunction. If DRC does not detect any errors, BitGen produces a bitstream file unless you use **bitgen -j** as described in [BitGen -j \(No BIT File\)](#).

-f (Execute Commands File)

This option executes the command line arguments in the specified *command_file*.

Syntax

-f *command_file*

For more information on the **-f** option, see [-f \(Execute Commands File\)](#) in the Introduction chapter.

-g (Set Configuration)

This option specifies the startup timing and other bitstream options for Xilinx® FPGA devices. The configuration is set using the sub-options defined below.

Syntax

```
-g sub-option:setting design.ncd design.bit design.pcf
```

For example, to enable Readback, use the following syntax:

```
bitgen -g readback
```

For a list of specific settings, use **bitgen -h [architecture]**. The default value may vary by architecture.

Note All sub-options for the **bitgen -g** option are case insensitive.

Sub-Options and Settings

The following sections describe the sub-options and settings for **bitgen -g** in alphabetic order.

• ActiveReconfig	• en_porb	• M0Pin	• RevisionSelect
• Binary	• en_sw_gsr	• M1Pin	• RevisionSelect_tristate
• BPI_1st_read_cycle	• Encrypt	• M2Pin	• Security
• BPI_page_size	• EncryptKeySelect	• Match_cycle	• SelectMapAbort
• bpi_sync_mode	• EssentialBits	• MultiBootMode	• StartCBC
• BusyPin	• ExtMasterCclk_divide	• multipin_wakeup	• StartupClk
• CclkPin	• ExtMasterCclk_en	• next_config_addr	• sw_clk
• Compress	• failsafe_user	• next_config_boot_mode	• sw_gts_cycle
• ConfigFallback	• Glutmask	• next_config_new_mode	• sw_gwe_cycle
• ConfigRate	• golden_config_addr	• next_config_reboot	• SPI_32bit_addr
• CRC	• GTS_cycle	• next_config_register_write	• SPI_buswidth
• CsPin	• GWE_cycle	• OverTempPowerDown	• SPI_Fall_Edge
• DCIUpdateMode	• HKey	• PartialGCLK	• TckPin
• DCMShutdown	• HswapenPin	• PartialLeft	• TdiPin
• DebugBitstream	• icap_select	• PartialMask0 ...	• TdoPin
• DinPin	• IEEE1532	• PartialRight	• TIMER_CFG
• DISABLE_JTAG	• InitPin	• Persist	• TIMER_USR
• DONE_cycle	• JTAG_SysMon	• PowerdownPin	• TmsPin
• DonePin	• JTAG_XADC	• ProgPin	• UnusedPin
• DonePipe	• Key0	• RdWrPin	• USR_ACCESS
• drive_awake	• KeyFile	• ReadBack	• UserID
• DriveDone	• LCK_cycle	• reset_on_error	• wakeup_mask

ActiveReconfig

Prevents the assertions of GHIGH and GSR during configuration. This is required for the active partial reconfiguration enhancement features.

Devices	Virtex®-4, Virtex-5, Virtex-6, Spartan®-3, Spartan-3A, Spartan-3E, Spartan-6, and 7 series devices
Settings	No, Yes
Default	No

Binary

Creates a binary file containing only programming data. Use **Binary** to extract and view programming data. Changes to the header do not affect the extraction process.

Devices	Virtex®-4, Virtex-5, Virtex-6, Spartan®-3, Spartan-3A, Spartan-3E, Spartan-6, and 7 series devices
Settings	No, Yes
Default	No

BPI_1st_read_cycle

Helps synchronize BPI configuration with the timing of page mode operations in Flash devices. It allows you to set the cycle number for a valid read of the first page. The BPI_page_size must be set to 4 or 8 for this option to be available

Devices	Virtex-5, Virtex-6, and 7 series devices
Settings	1, 2, 3, 4
Default	1

BPI_page_size

For BPI configuration, this sub-option lets you specify the page size which corresponds to number of reads required per page of Flash memory.

Devices	Virtex-5, Virtex-6, and 7 series devices
Settings	1, 4, 8
Default	1

bpi_sync_mode

Sets the BPI synchronous configuration mode for different types of BPI flash devices.

- **Disable** (the default) disables the synchronous configuration mode.
- **Type1** enables the synchronous configuration mode and settings to support the Micron G18(F) family.
- **Type2** enables the synchronous configuration mode and settings to support the Micron (Numonyx) P30 family.

Devices	7 series devices
Settings	Disable, Type1, Type2
Default	Disable

For more information, please consult the [7 Series FPGAs Configuration User Guide \(UG470\)](#)

BusyPin

Lets you add an internal resistor to either weakly pull up or pull down the pin. Selecting **Pullnone** does not add a resistor, and as a result the pin is not pulled in either direction.

Devices	Virtex-4, Virtex-5, and Virtex-6 devices
Settings	Pullup, Pulldown, Pullnone
Default	Pullup

CclkPin

Adds an internal pull-up to the Cclk pin. The **Pullnone** setting disables the pullup.

Devices	Virtex-4, Virtex-5, Virtex-6, 7 series, and Spartan-3 devices
Settings	Pullup, Pullnone
Default	Pullup

Compress

Uses the multiple frame write feature in the bitstream to reduce the size of the bitstream, not just the Bitstream (BIT) file. Using **Compress** does not guarantee that the size of the bitstream will shrink. Compression is enabled by setting **bitgen -g compress**. Compression is disabled by not setting it.

The partial BIT files generated with the **bitgen -r** option automatically use the multiple frame write feature, and are compressed bitstreams.

Devices	Virtex®-4, Virtex-5, Virtex-6, Spartan®-3, Spartan-3A, Spartan-3E, Spartan-6, and 7 series devices
Settings	None
Default	Off

ConfigFallback

Enables or disables the loading of a default bitstream when a configuration attempt fails.

Devices	Virtex-5, Virtex-6, and 7 series devices
Settings	Enable, Disable
Default	Enable for Virtex-5 and Virtex-6 devices Disable for 7 series devices

ConfigRate

BitGen uses an internal oscillator to generate the configuration clock, Cclk, when configuring in a master mode. Use this sub-option to select the rate for Cclk.

Devices	Settings	Default
Virtex-4 devices	4, 5, 7, 8, 9, 10, 13, 15, 20, 26, 30, 34, 41, 45, 51, 55, 60	4
Virtex-5 devices	2, 6, 9, 13, 17, 20, 24, 27, 31, 35, 38, 42, 46, 49, 53, 56, 60	2
Virtex-6 devices	2, 4, 6, 10, 12, 16, 22, 26, 33, 40, 50, 66	2
Spartan-3 devices	6, 3, 12, 25, 50	6
Spartan-3A devices	6, 1, 3, 7, 8, 10, 12, 13, 17, 22, 25, 27, 33, 44, 50, 100	6
Spartan-3E devices	1, 3, 6, 12, 25, 50	1
Spartan-6 devices	2, 4, 6, 10, 12, 16, 22, 26, 33, 40, 50, 66	2
7 series devices	3, 6, 9, 12, 16, 22, 26, 33, 40, 50, 66	3

CRC

Controls the generation of a Cyclic Redundancy Check (CRC) value in the bitstream. When enabled, a unique CRC value is calculated based on bitstream contents. If the calculated CRC value does not match the CRC value in the bitstream, the device will fail to configure. When CRC is disabled a constant value is inserted in the bitstream in place of the CRC, and the device does not calculate a CRC.

Devices	Virtex®-4, Virtex-5, Virtex-6, Spartan®-3, Spartan-3A, Spartan-3E, Spartan-6, and 7 series devices
Settings	Enable, Disable
Default	Enable

CsPin

Lets you add an internal resistor to either weakly pull up or pull down the pin. Selecting **Pullnone** does not add a resistor, and as a result the pin is not pulled in either direction.

Devices	Virtex-4, Virtex-5, and Virtex-6 devices
Settings	Pullup, Pulldown, Pullnone
Default	Pullup

DCIUpdateMode

Controls how often the Digitally Controlled Impedance circuit attempts to update the impedance match for DCI IOSTANDARDS.

Devices	Virtex-6, Virtex-4, Virtex-5, 7 series, and Spartan-3 devices
Settings	As required, Continuous, Quiet
Default	Quiet (Virtex-6 devices) As required (All other supported devices)

DCMShutdown

Specifies that the digital clock manager (DCM) should reset if the SHUTDOWN and AGHIGH commands are loaded into the configuration logic.

Devices	Spartan-3 and Spartan-3E devices
Settings	Disable, Enable
Default	Disable

DebugBitstream

Lets you create a debug bitstream. A debug bitstream is significantly larger than a standard bitstream. **DebugBitstream** can be used only for master and slave serial configurations. **DebugBitstream** is not valid for Boundary Scan or Slave Parallel/SelectMAP.

Devices	Virtex®-4, Virtex-5, Virtex-6, Spartan®-3, Spartan-3A, Spartan-3E, Spartan-6, and 7 series devices
Settings	No, Yes
Default	No

In addition to a standard bitstream, a debug bitstream offers the following features:

- Writes 32 0s to the LOUT register after the synchronization word
- Loads each frame individually
- Performs a Cyclic Redundancy Check (CRC) after each frame
- Writes the frame address to the LOUT register after each frame

DinPin

Lets you add an internal resistor to weakly pull up or pull down the pin. Selecting **Pullnone** does not add a resistor, and as a result the pin is not pulled in either direction.

Devices	Virtex-4, Virtex-5, and Virtex-6 devices
Settings	Pullup, Pulldown, Pullnone
Default	Pullup

DISABLE_JTAG

Disables communication to the Boundary Scan (BSCAN) block via JTAG after configuration.

Devices	Virtex-6 and 7 series devices
Settings	No, Yes
Default	No

DONE_cycle

Selects the Startup phase that activates the FPGA Done signal. Done is delayed when **DonePipe=Yes**.

Devices	Virtex®-4, Virtex-5, Virtex-6, Spartan®-3, Spartan-3A, Spartan-3E, Spartan-6, and 7 series devices
Settings	1, 2, 3, 4, 5, 6
Default	4

DonePin

Adds an internal pull-up to the DONE pin. The BitGen **Pullnone** setting disables the pullup. Use **DonePin** only if you intend to connect an external pull-up resistor to this pin. The internal pull-up resistor is automatically connected if you do not use **DonePin**.

Devices	Virtex®-4, Virtex-5, Virtex-6, Spartan®-3, Spartan-3A, Spartan-3E, Spartan-6, and 7 series devices
Settings	Pullup, Pullnone
Default	Pullup

DonePipe

Tells the FPGA device to wait on the CFG_DONE (DONE) pin to go High and then wait for the first clock edge before moving to the **Done** state.

Devices	Virtex®-4, Virtex-5, Virtex-6, Spartan®-3, Spartan-3A, Spartan-3E, Spartan-6, and 7 series devices
Settings (all devices)	No, Yes
Default (7 series)	Yes
Default (all other devices)	No

drive_aware

Specifies whether the AWAKE pin is actively driven or acts as an open drain, which requires an open resistor to pull it high. The AWAKE pin monitors whether or not the device is in SUSPEND mode.

Devices	Spartan-3A and Spartan-6 devices
Settings	No, Yes
Default	No

DriveDone

Actively drives the DONE Pin high as opposed to using a pullup.

Devices	Virtex®-4, Virtex-5, Virtex-6, Spartan®-3, Spartan-3A, Spartan-3E, and Spartan-6 , and monolithic 7 series devices (see note)
Settings	No, Yes
Default	No

Note DriveDone is not supported for 7 series multiple SLR devices.

en_porb

Specifies whether Power-On Reset (POR) detection is active for a SUSPEND state. By default **en_porb** is enabled (**Yes**), which means **por_b** detection is always active. When the voltage is too low, the FPGA device is reset.

If **en_porb** is set to **No**:

- **por_b** detection is enabled when the SUSPEND pin is low
- **por_b** detection is disabled when the SUSPEND pin is high.

Devices	Spartan-3A devices
Settings	Yes, No
Default	Yes

en_sw_gsr

Restores the value of the flip-flop from the memory cell value when the FPGA wakes up from suspend mode.

Devices	Spartan-3A and Spartan-6 devices
Settings	No, Yes
Default	No

Encrypt

Encrypts the bitstream.

Devices	Virtex-4, Virtex-5, Virtex-6, and 7 series devices, and Spartan-6 devices LX75/T and larger
Settings	No, Yes
Default	No

For more information on encryption, see <http://www.xilinx.com/products/ipcenter/DES.htm>.

EncryptKeySelect

Determines the location of the AES encryption key to be used, either from the battery-backed RAM (BBRAM) or the eFUSE register.

Note This property is only available when the Encrypt option is set to True.

Devices	Virtex-6 and 7 series devices, and Spartan-6 devices LX75/T and larger
Settings	bbram, efuse
Default	bbram

For more information on encryption, see <http://www.xilinx.com/products/ipcenter/DES.htm>.

EssentialBits

Generates essential bits data files in ASCII format (.ebc and .ebd extensions). The EBC file contains device configuration data. The EBD file contains mask data that indicates which bits of the EBC file are essential to the circuitry of the design. Mask bits assigned a value of 1 are essential to the design, and mask bits assigned a value of 0 are not. When Essential Bits is Yes, the following summary will appear in the BitGen log file as well on the console:

```
This design has 2553201 essential bits out of 10518304 total (24.27%).
```

Devices	Spartan-6, Virtex-5, and Virtex-6 devices
Settings	No, Yes
Default	No

Note The EssentialBits algorithm exhibits moderate false positives (bits marked essential but which do not affect the functionality of the design) with less than 100 PPM false negatives (bits classified as non-essential but which will affect the functionality).

ExtMasterCclk_divide

Determines if the external master configuration clock is divided internally.

Note This property is only available if the ExtMasterCclk_en property is set to Yes.

Devices	Spartan-6 devices
Settings	1, multiples of 2 from 2 to 1022
Default	1

ExtMasterCclk_en

Allows an external clock to be used as the configuration clock for all master modes. The external clock must be connected to the dual-purpose USERCCLK pin.

Devices	Spartan-6 and 7 series devices
Settings (Spartan-6 devices)	No, Yes
Settings (7 series devices)	Disable, div-8, div-4, div-2, div-1
Default (Spartan-6 devices)	No
Default (7 series devices)	Disable

Note For 7 series devices, enable the external clock and set the divider value with this option. For Spartan-6 devices, use this option to enable the clock, and use ExtMasterCclk_divide to set the divider value.

failsafe_user

Sets the address of the GENERAL5 register, which is a 16-bit register that allows users to store and access any extra information desired for the failsafe scheme.

Devices	Spartan-6 devices
Settings	<4-digit hex string>
Default	0x0000

Glutmask

Masks out the LUTRAM frame during configuration readback or SEU readback.

Devices	Spartan-3A and Spartan-6 devices
Settings	Yes, No
Default	Yes

golden_config_addr

Sets the address in GENERAL3,4 for the golden configuration image.

Devices	Spartan-6 devices
Settings	<8-digit hex string>
Default	0x00000000

GTS_cycle

Selects the Startup phase that releases the internal tristate control to the I/O buffers. The **Done** setting releases GTS when the **DoneIn** signal is High. The **DoneIn** setting is either the value of the Done pin or a delayed version if **DonePipe=Yes**.

Devices	Virtex®-4, Virtex-5, Virtex-6, Spartan®-3, Spartan-3A, Spartan-3E, Spartan-6, and 7 series devices
Settings	1, 2, 3, 4, 5, 6, Done, Keep
Default	5

GWE_cycle

Selects the Startup phase that asserts the internal write enable to flip-flops, LUT RAMs, and shift registers. GWE_cycle also enables the BRAMS. Before the Startup phase, both BRAM writing and reading are disabled. The **Done** setting asserts GWE when the **DoneIn** signal is High. **DoneIn** is either the value of the Done pin or a delayed version if **DonePipe=Yes**. The BitGen **Keep** setting is used to keep the current value of the GWE signal

Devices	Virtex®-4, Virtex-5, Virtex-6, Spartan®-3, Spartan-3A, Spartan-3E, Spartan-6, and 7 series devices
Settings	1, 2, 3, 4, 5, 6, Done, Keep
Default	6

HKey

HKey sets the HMAC authentication key for bitstream encryption. Virtex-6 and 7 series devices have an on-chip bitstream-keyed Hash Message Authentication Code (HMAC) algorithm implemented in hardware to provide additional security beyond AES decryption alone. These devices require both AES and HMAC keys to load, modify, intercept, or clone the bitstream.

The **pick** setting tells BitGen to select a random number for the value. To use this option, you must first set **-g Encrypt:Yes**.

Devices	Virtex-6 and 7 series devices
Settings	Pick, <hex string>
Default	Pick

For more information on encryption, see <http://www.xilinx.com/products/ipcenter/DES.htm>.

HswapenPin

Adds a pull-up, pull-down, or neither to the Hswapen pin. The BitGen **Pullnone** setting shows there is no connection to either the pull-up or the pull-down.

Devices	Virtex-4, Virtex-5, Virtex-6, and Spartan-3, devices
Settings	Pullup, Pulldown, Pullnone
Default	Pullup

icap_select

Selects between the top and bottom ICAP ports.

Devices	7 series
Settings	Top, Bottom
Default	Top

IEEE1532

Creates the IEEE 1532 Configuration File and requires that StartUpClk is set to JTAG Clock.

Devices	Virtex®-4, Virtex-5, Virtex-6, Spartan®-3, Spartan-3A, Spartan-3E, Spartan-6, and 7 series devices
Settings	No, Yes
Default	No

InitPin

Specifies whether you want to add a **Pullup** resistor to the INIT pin, or leave the INIT pin floating.

Devices	Virtex-4, Virtex-5, Virtex-6, and 7 series devices
Settings	Pullup, Pullnone
Default	Pullup

JTAG_SysMon

Enables or disables the JTAG connection to the System Monitor.

Devices	Virtex-5 and Virtex-6 devices
Settings	Enable, Disable
Default	Enable

For Virtex-5 devices, when this option is Disable, attribute bit `sysmon_test_a[1]` is set to 1. For Virtex-6 devices, when this option is Disable, attribute bits `sysmon_test_e[2:0]` are set to 3'b111.

JTAG_XADC

Enables or disables the JTAG connection to the XADC.

Devices	7 series devices
Settings	Enable, Disable, Status_Only
Default	Enable

When this option is Disable, attribute bits `sysmon_test_e[2:0]` are set to 3'b111. When this option is Status_Only, attribute bits `sysmon_test_e[3,6,7]` are set to 3'b111.

Key0

Key0 sets the AES encryption key for bitstream encryption. The **pick** setting tells BitGen to select a random number for the value. To use this option, you must first set **-g Encrypt:Yes**.

Note Virtex-6 devices require both AES and HMAC keys to load, modify, intercept, or clone the bitstream.

Devices	Virtex-4, Virtex-5, Virtex-6, and 7 series devices, and Spartan-6 devices LX75/T and larger
Settings	Pick, <hex string>
Default	Pick

For more information on encryption, see <http://www.xilinx.com/products/ipcenter/DES.htm>.

KeyFile

Specifies the name of the input encryption file (with a .nky file extension). To use this option, you must first set **-g Encrypt:Yes**.

Devices	Virtex-4, Virtex-5, Virtex-6, and 7 series devices, and Spartan-6 devices LX75/T and larger
Settings	<string>
Default	Not specified

For more information on encryption, see <http://www.xilinx.com/products/ipcenter/DES.htm>.

LCK_cycle

Selects the Startup phase to wait until DLLs/DCMs/PLLs lock. If you select **NoWait**, the Startup sequence does not wait for DLLs/DCMs/PLLs to lock.

Devices	Virtex®-4, Virtex-5, Virtex-6, Spartan®-3, Spartan-3A, Spartan-3E, Spartan-6, and 7 series devices
Settings (Virtex-6 and Spartan-6 devices)	NoWait, 0,1, 2, 3, 4, 5, 6, 7
Settings (All other devices)	NoWait, 0,1, 2, 3, 4, 5, 6
Default	NoWait

MOPin

Adds an internal pull-up, pull-down or neither to the M0 pin. Select **Pullnone** to disable both the pull-up resistor and the pull-down resistor on the M0 pin.

Devices	Virtex-4, Virtex-5, Virtex-6, 7 series, and Spartan-3 devices
Settings	Pullup, Pulldown, Pullnone
Default	Pullup

M1Pin

Adds an internal pull-up, pull-down or neither to the M1 pin. Select **Pullnone** to disable both the pull-up resistor and pull-down resistor on the M1 pin.

Devices	Virtex-4, Virtex-5, Virtex-6, 7 series, and Spartan-3 devices
Settings	Pullup, Pulldown, Pullnone
Default	Pullup

M2Pin

Adds an internal pull-up, pull-down or neither to the M2 pin. Select **Pullnone** to disable both the pull-up resistor and pull-down resistor on the M2 pin.

Devices	Virtex-4, Virtex-5, Virtex-6, 7 series, and Spartan-3 devices
Settings	Pullup, Pulldown, Pullnone
Default	Pullup

Match_cycle

Specifies a stall in the Startup cycle until digitally controlled impedance (DCI) match signals are asserted.

DCI matching does not begin on the Match_cycle that was set in BitGen. The Startup sequence simply waits in this cycle until DCI has matched. Given that there are a number of variables in determining how long it will take DCI to match, the number of CCLK cycles required to complete the Startup sequence may vary in any given system. Ideally, the configuration solution should continue driving CCLK until DONE goes high.

Devices	Virtex-4, Virtex-5, Virtex-6, 7 series, and Spartan-3 devices
Settings	Auto, 0, 1, 2, 3, 4, 5, 6, NoWait
Default	Auto

Note When the **Auto** setting is specified, BitGen searches the design for any DCI I/O standards. If DCI standards exist, BitGen uses **Match_cycle:2**. Otherwise, BitGen uses **Match_cycle:NoWait**.

MultiBootMode

Enables or disables MultiBoot operation of the Spartan-3E device. If disabled, the FPGA device ignores the value on the MBT pin of the startup block.

Devices	Spartan-3E devices
Settings	No, Yes
Default	No

multipin_wakeup

Enables the System Configuration Port (SCP) pins to return the FPGA from suspend mode.

Devices	Spartan-6 devices
Settings	No, Yes
Default	No

next_config_addr

Sets the starting address for the next configuration in a MultiBoot setup, which is stored in the General1 and General2 registers.

Devices	Spartan-3A, Spartan-6, Virtex-6, and 7 series devices
Settings	<8-digit hex string>
Default	none

next_config_boot_mode

Sets the configuration mode for the next configuration in a MultiBoot setup. For Spartan-6 the MSB must be 0, the next two bits represent Mode pins M[1:0].

Devices	Spartan-3A and Spartan-6 devices
Settings	<3-bit binary string>
Default	001

next_config_new_mode

Selects between the mode value on the mode pins or the mode value specified in the bitstream by the `next_config_boot_mode` sub-option. If **Yes** is chosen, the mode value specified by the `next_config_boot_mode` sub-option overrides the value on the mode pins during a subsequent MultiBoot configuration.

Devices	Spartan-3A and Spartan-6 devices
Settings	No, Yes
Default	No

next_config_reboot

Lets you remove the IPROG command from the bitstream in multiboot flows. Specifying `-g next_config-reboot:Disable` removes the IPROG command from the bitfile.

Devices	Spartan-6 and 7 series devices
Settings	Enable, Disable
Default	Enable

next_config_register_write

Enables the multi-boot header for a golden bitstream. This option is for use with the Golden Image and will contain the address of the Multi-Boot Image. When the device loads the Golden Image with this header attached it will jump to the address defined by `next_config_addr` and load the multi-boot image. If configuration of the multi-boot image does not successfully complete the device will reload the Golden Image, skipping this header.

Devices	Spartan-3A and Spartan-6 devices
Settings	Enable, Disable
Default	Enable

OverTempPowerDown

Enables the device to shut down when the system monitor detects a temperature beyond the acceptable operational maximum. An external circuitry setup for the System Monitor on is required in order to use this option.

Devices	Virtex-5, Virtex-6, and 7 series devices
Settings	Disable, Enable
Default	Disable

PartialGCLK

Adds the center global clock column frames into the list of frames to write out in a partial bitstream. `PartialGCLK` is equivalent to `PartialMask0:1`.

Devices	Spartan-3, Spartan-3A, and Spartan-3E devices
Settings	Not Specified
Default	Not Specified. No partial masks in use.

PartialLeft

Adds the left side frames of the device into the list of frames to write out in a partial bitstream. This includes CLB, IOB, and BRAM columns. It does not include the center global clock column.

Devices	Spartan-3, Spartan-3A, and Spartan-3E devices
Settings	None
Default	Not Specified. No partial masks in use.

PartialMask0 ...

The `PartialMask0`, `PartialMask1`, and `PartialMask2` settings generate a bitstream comprised of only the major addresses of block type `<0, 1, or 2>` that have enabled value in the mask. The block type is all non-block ram initialization data frames in the applicable device and its derivatives.

Devices	Spartan-3, Spartan-3A, and Spartan-3E devices
Settings	All columns enabled, major address mask
Default	Not Specified. No partial masks in use.

PartialRight

Adds the right side frames of the device into the list of frames to write out in a partial bitstream. This includes CLB, IOB, and BRAM columns. It does not include the center global clock column.

Devices	Spartan-3, Spartan-3A, and Spartan-3E devices
Settings	None
Default	Not Specified. No partial masks in use.

Persist

Prohibits use of the SelectMAP mode pins for use as user I/O. Refer to the data sheet for a description of SelectMAP mode and the associated pins.

Persist is needed for Readback and Partial Reconfiguration using the SelectMAP configuration pins, and should be used when either SelectMAP or Serial modes are used. Only the SelectMAP pins are affected, but this option should be used for access to config pins (other than JTAG) after configuration.

Devices	Virtex®-4, Virtex-5, Virtex-6, Spartan®-3, Spartan-3A, Spartan-3E, Spartan-6, and 7 series devices
Settings	No, Yes
Default	No

Note The pins affected by this command will differ depending on the mode selected by the CONFIG_MODE constraint (see the [Constraints Guide \(UG625\)](#)). If you do not set a CONFIG_MODE constraint, the first 8 SelectMAP pins will be reserved when Persist is set to Yes.

PowerdownPin

Puts the pin into sleep mode by specifying whether or not the internal pullup on the pin is enabled.

Devices	Virtex-4 devices
Settings	Pullup, Pullnone
Default	Pullup

ProgPin

Adds an internal pull-up to the ProgPin pin. The BitGen **Pullnone** setting disables the pullup. The pullup affects the pin after configuration.

Devices	Virtex®-4, Virtex-5, Virtex-6, Spartan®-3, Spartan-3A, Spartan-3E, Spartan-6, and 7 series devices
Settings	Pullup, Pullnone
Default	Pullup

RdWrPin

Lets you add an internal resistor to either weakly pull up or pull down the pin. Selecting **Pullnone** does not add a resistor, and as a result the pin is not pulled in either direction.

Devices	Virtex-4, Virtex-5, and Virtex-6 devices
Settings	Pullup, Pulldown, Pullnone
Default	Pullup

ReadBack

Lets you perform the Readback function by creating the necessary readback files. Specifying **bitgen -g Readback** creates the .rbb, .rbd, and .msd files.

Devices	Virtex®-4, Virtex-5, Virtex-6, Spartan®-3, Spartan-3A, Spartan-3E, Spartan-6, and 7 series devices
Settings	None
Default	Not Specified. The readback files are not created.

Note Using **bitgen -b** with **bitgen -g Readback** also generates an ASCII readback command file (`file_name.rba`).

reset_on_error

Automatically resets the FPGA device when a CRC error is detected. This applies to master mode configuration only.

Devices	Spartan-3A and Spartan-6 devices
Settings	No, Yes
Default	No

RevisionSelect

Specifies the internal value of the RS[1:0] settings in the Warm Boot Start Address (WBSTAR) register for the next warm boot.

Devices	7 series devices
Settings	00, 01, 10, 11
Default	00

RevisionSelect_tristate

Specifies the whether the RS[1:0] tristate is enabled by setting the option in the Warm Boot Start Address (WBSTAR).

Devices	7 series devices
Settings	Disable, Enable
Default	Disable

Security

Specifies whether to disable Readback and Reconfiguration.

Devices	Virtex®-4, Virtex-5, Virtex-6, Spartan®-3, Spartan-3A, Spartan-3E, Spartan-6, and 7 series devices
Settings (Spartan-3A and Spartan-6 devices)	None, Level1, Level2, Level3
Settings (all other devices)	None, Level1, Level2
Default (All devices)	None

Note Specifying **Security Level1** disables Readback. Specifying **Security Level2** disables Readback and Reconfiguration.

SelectMapAbort

Enables or disables the SelectMAP mode Abort sequence. If disabled, an Abort sequence on the device pins is ignored.

Devices	Virtex-5 devices
Settings	Enable, Disable
Default	Enable

SPI_32bit_addr

Enables SPI 32-bit address style, which is required for SPI devices with storage of 256 Mb and larger.

Devices	7 series devices
Settings	No, Yes
Default	No

SPI_buswidth

Sets the SPI bus to Dual (x2) or Quad (x4) mode for Master SPI configuration from third party SPI Flash devices.

Devices	Spartan-6 and 7 series devices
Settings	1, 2, 4
Default	1

SPI_Fall_Edge

Sets the FPGA to use a falling edge clock for SPI data capture. This improves timing margins and may allow faster clock rates for configuration.

Devices	7 series devices
Settings	No, Yes
Default	No

StartCBC

Sets the starting cipher block chaining (CBC) value. The BitGen **pick** setting enables BitGen to select a random number for the value.

Devices	Virtex-4, Virtex-5, Virtex-6, and 7 series devices, and Spartan-6 devices LX75/T and larger
Settings	Pick, <32-bit hex string>
Default	Pick

StartupClk

The BitGen **StartupClk** sequence following the configuration of a device can be synchronized to either **Cclk**, a **User Clock**, or the **JTAG Clock**. The default is **Cclk**.

- **Cclk** lets you synchronize to an internal clock provided in the FPGA device.
- **UserClk** lets you synchronize to a user-defined signal connected to the CLK pin of the STARTUP symbol.
- **JtagClk** lets you synchronize to the clock provided by JTAG. This clock sequences the TAP controller which provides the control logic for JTAG.

Devices	Virtex®-4, Virtex-5, Virtex-6, Spartan®-3, Spartan-3A, Spartan-3E, Spartan-6, and 7 series devices
Settings	Cclk (pin see Note), UserClk (user-supplied), JtagClk
Default	Cclk

Note In modes where Cclk is an output, the pin is driven by an internal oscillator.

sw_clk

Specifies which startup clock is used when the device wakes up from suspend mode.

Devices	Spartan-3A and Spartan-6 devices
Settings	Startupclk, Internalclk
Default	Startupclk

sw_gts_cycle

Applies when the device wakes up from suspend mode. Possible values are between 1 and 1024.

Devices	Spartan-3A and Spartan-6 devices
Settings	4, <string>
Default	4

sw_gwe_cycle

Applies when the device wakes up from suspend mode. Possible values are between 1 and 1024.

Devices	Spartan-3A and Spartan-6 devices
Settings	5, <string>
Default	5

TckPin

Adds a pull-up, a pull-down or neither to the TCK pin, the JTAG test clock. Selecting one setting enables it and disables the others. The BitGen **Pullnone** setting shows that there is no connection to either the pull-up or the pull-down.

Devices	Virtex®-4, Virtex-5, Virtex-6, Spartan®-3, Spartan-3A, Spartan-3E, Spartan-6, and 7 series devices
Settings	Pullup, Pulldown, Pullnone
Default	Pullup

TdiPin

Adds a pull-up, a pull-down, or neither to the TDI pin, the serial data input to all JTAG instructions and JTAG registers. Selecting one setting enables it and disables the others. The BitGen **Pullnone** setting shows that there is no connection to either the pull-up or the pull-down.

Devices	Virtex®-4, Virtex-5, Virtex-6, Spartan®-3, Spartan-3A, Spartan-3E, Spartan-6, and 7 series devices
Settings	Pullup, Pulldown, Pullnone
Default	Pullup

TdoPin

Adds a pull-up, a pull-down, or neither to the TdoPin pin, the serial data output for all JTAG instruction and data registers. Selecting one setting enables it and disables the others. The BitGen **Pullnone** setting shows that there is no connection to either the pull-up or the pull-down.

Devices	Virtex®-4, Virtex-5, Virtex-6, Spartan®-3, Spartan-3A, Spartan-3E, Spartan-6, and 7 series devices
Settings	Pullup, Pulldown, Pullnone
Default	Pullup

TIMER_CFG

Sets the value of the Watchdog Timer in Configuration mode. This option cannot be used at the same time as TIMER_USR.

Devices	Virtex-5, Virtex-6, Spartan-6, and 7 series devices
Settings (Spartan-6 devices)	<4-digit hex string>
Settings (Virtex-5 and Virtex-6 devices)	<6-digit hex string>
Settings (7 series devices)	<8-digit hex string>
Default for all devices	None

TIMER_USR

Sets the value of the Watchdog Timer in User mode. This option cannot be used at the same time as TIMER_CFG.

Devices	Virtex-5, Virtex-6, and 7 series devices
Settings (Virtex-5 and Virtex-6 devices)	<6-digit hex string>
Settings (7 series devices)	<8-digit hex string>
Default (Virtex-5 and Virtex-6 devices)	0x000000
Default (7 series devices)	0x00000000

TmsPin

Adds a pull-up, pull-down, or neither to the TMS pin, the mode input signal to the TAP controller. The TAP controller provides the control logic for JTAG. Selecting one setting enables it and disables the others. The BitGen **Pullnone** setting shows that there is no connection to either the pull-up or the pull-down.

Devices	Virtex®-4, Virtex-5, Virtex-6, Spartan®-3, Spartan-3A, Spartan-3E, Spartan-6, and 7 series devices
Settings	Pullup, Pulldown, Pullnone
Default	Pullup

UnusedPin

Adds a pull-up, a pull-down, or neither to the unused device pins and the serial data output (TDO) for all JTAG instruction and data registers. Selecting one setting enables it and disables the others. The BitGen **Pullnone** setting shows that there is no connection to either the pull-up or the pull-down.

Devices	Virtex®-4, Virtex-5, Virtex-6, Spartan®-3, Spartan-3A, Spartan-3E, Spartan-6, and 7 series devices
Settings	Pulldown, Pullup, Pullnone
Default	Pulldown

USR_ACCESS

Writes an 8-digit hexadecimal string, or a timestamp into the AXSS configuration register.

The format of the timestamp value is dddd MM yy hh mm ss : day, month, year (year 2000 = 00000), hour, minute, seconds. The contents of this register may be directly accessed by the FPGA fabric via the USR_ACCESS primitive.

Devices	Virtex-5, Virtex-6, and 7 series devices
Settings	none, <8-digit hex string>, TIMESTAMP
Default	none

UserID

Used to identify implementation revisions. You can enter up to an 8-digit hexadecimal string in the **User ID** register.

Devices	Virtex®-4, Virtex-5, Virtex-6, Spartan®-3, Spartan-3A, Spartan-3E, Spartan-6, and 7 series devices
Settings	<8-digit hex string>
Default	0xFFFFFFFF

wakeup_mask

Determines which of the eight SCP pins are enabled for wake-up from suspend mode.

Note This option is only available if `multipin_wakeup` is set to True.

Devices	Spartan-6 devices
Settings	<2-digit hex string>
Default	0x00

-intstyle (Integration Style)

This option limits screen output, based on the integration style that you are running, to warning and error messages only.

Syntax

```
-intstyle ise|xflow|silent
```

When using **-intstyle**, one of three modes must be specified:

- **-intstyle ise** indicates the program is being run as part of an integrated design environment.
- **-intstyle xflow** indicates the program is being run as part of an integrated batch flow.
- **-intstyle silent** limits screen output to warning and error messages only.

Note **-intstyle** is automatically invoked when running in an integrated environment such as Project Navigator or XFLOW.

-j (No BIT File)

This option tells BitGen not to create a Bitstream (BIT) file. Use **bitgen -j** when you want to generate a report without producing a bitstream. For example, use **bitgen -j** to run DRC without producing a bitstream file. However, the `.msk` or `.rbt` files may still be created.

Syntax

`-j`

-l (Create a Logic Allocation File)

This option creates an ASCII logic allocation file (`design.ll`) for the selected design. The logic allocation file shows the bitstream position of latches, flip-flops, IOB inputs and outputs, and the bitstream position of LUT programming and Block RAMs.

Syntax

`-l`

In some applications, you may want to observe the contents of the FPGA internal registers at different times. The file created by **bitgen -l** helps you identify which bits in the current bitstream represent outputs of flip-flops and latches. Bits are referenced by frame and bit number within the frame.

The iMPACT tool uses the `design.ll` file to locate signal values inside a readback bitstream.

-m (Generate a Mask File)

This option creates a mask file. This file determines which bits in the bitstream should be compared to readback data for verification purposes.

Syntax

`-m`

-r (Create a Partial Bit File)

This option is used to create a partial Bitstream (BIT) file.

It compares that BIT file to the Native Circuit Description (NCD) file given to BitGen. Instead of writing out a full BIT file, it writes out only the part of the BIT file that is different from the original BIT file.

Syntax

`-r bit_file`

-w (Overwrite Existing Output File)

This option lets you overwrite an existing BitGen output file.

Syntax

`-w`

For more information on BitGen output files, see the [BitGen Overview](#).

BSDLANno

This chapter describes the BSDLANno utility.

BSDLANno Overview

BSDLANno is a Xilinx® command line tool that automatically modifies a Boundary Scan Description Language (BSDL) file for post-configuration interconnect testing. BSDLANno:

- Obtains the necessary design information from the routed Native Circuit Description (NCD) file (for FPGA devices) or the PNX file (for CPLD devices)
- Generates a BSDL file that reflects the post-configuration boundary scan architecture of the device

The boundary scan architecture is changed when the device is configured because certain connections between the boundary scan registers and pad may change. These changes must be communicated to the boundary scan tester through a post-configuration BSDL file. If the changes to the boundary scan architecture are not reflected in the BSDL file, boundary scan tests may fail.

The Boundary Scan Description Language (BSDL) is defined by IEEE specification 1149.1 as a common way of defining device boundary scan architecture. Xilinx provides both 1149.1 and 1532 BSDL files that describe pre-configuration boundary scan architecture.

For most Xilinx device families, the boundary scan architecture changes after the device is configured because the boundary scan registers sit behind the output buffer and the input sense amplifier:

BSCAN Register -> output buffer/input sense amp -> PAD

The hardware is arranged in this manner so that the boundary scan logic operates at the I/O standard specified by the design. This allows boundary scan testing across the entire range of available I/O standards.

BSDLANno Device Support

This program is compatible with the following device families:

- 7 series
- Spartan®-3, Spartan-3A, Spartan-3E, and Spartan-6
- Virtex®-4, Virtex-5, and Virtex-6
- CoolRunner™ XPLA3 and CoolRunner-II
- XC9500 and XC9500XL

Input Files

BSDLANno requires two input files to generate a post-configuration Boundary Scan Description Language (BSDL) file:

- A pre-configuration BSDL file that is automatically read from the Xilinx installation area.
- The routed Native Circuit Description (NCD) file for FPGA devices, or the PNX file for CPLD devices specified as the input file.

File	Acronym	Extension	Description/Notes
Native Circuit Description	NCD	.ncd	A physical description of the design mapped, placed and routed in the target device. For FPGA devices.
Boundary Scan Description Language	BSDL	.bsd	The length of the BSDL output file name, including the .bsd extension, cannot exceed 24 characters.
External Pin Description in XDM Format	PNX	.pnx	For CPLD devices.

Output Files

The output from BSDLANno is an ASCII (text) formatted Boundary Scan Description Language (BSDL) file that has been modified to reflect:

- Signal direction (input/output/bidirectional)
- Unused I/Os
- Other design-specific boundary scan behavior.

BSDLANno Command Line Syntax

The BSDLANno command line syntax is:

```
bsdlanno [options] infile outfile[.bsd]
```

options is one or more of the options listed in [BSDLANno Command Line Options](#).

Enter options in any order, preceded them with a dash (minus sign on the keyboard) and separate them with spaces.

infile is the design source file for the specified design.

- For FPGA devices, *infile* is a routed (post-PAR) Native Circuit Description (NCD) file.
- For CPLD devices, *infile* is the `design.pnx` file.

outfile is the destination for the design-specific BSDL file with an optional `.bsd` extension.

BSDLANno Command Line Options

This section provides information on the BSDLANno command line options.

- `-intstyle` ([Integration Style](#))
- `-s` ([Specify BSDL file](#))

`-intstyle` (Integration Style)

This option limits screen output, based on the integration style that you are running, to warning and error messages only.

Syntax

```
-intstyle ise|xflow|silent
```

When using **-intstyle**, one of three modes must be specified:

- **-intstyle ise** indicates the program is being run as part of an integrated design environment.
- **-intstyle xflow** indicates the program is being run as part of an integrated batch flow.
- **-intstyle silent** limits screen output to warning and error messages only.

Note **-intstyle** is automatically invoked when running in an integrated environment such as Project Navigator or XFLOW.

BSDLANno -s (Specify BSDL file)

This option specifies the pre-configuration Boundary Scan Description Language (BSDL) file to be annotated.

Syntax

```
-s [IEEE1149|IEEE1532]
```

IEEE1149 and IEEE1532 versions of the pre-configuration BSDL file are currently available. Most users require the IEEE1149 version.

BSDLANno File Composition

Manufacturers of JTAG-compliant devices must provide Boundary Scan Description Language (BSDL) files for those devices. BSDL files describe the boundary scan architecture of a JTAG-compliant device, and are written in a subset language of VHDL. The main parts of an IEEE1149 BSDL file follow, along with an explanation of how BSDLANno modifies each section.

- [BSDLANno Entity Declaration](#)
- [BSDLANno Generic Parameter](#)
- [BSDLANno Logical Port Description](#)
- [BSDLANno Package Pin-Mapping](#)
- [BSDLANno USE Statement](#)
- [BSDLANno Scan Port Identification](#)
- [BSDLANno TAP Description](#)
- [BSDLANno Boundary Register Description](#)
- [Boundary Scan Description Language \(BSDL\) File Modifications for Single-Ended Pins](#)
- [Boundary Scan Description Language \(BSDL\) File Modifications for Differential Pins](#)
- [BSDLANno Modifications to the DESIGN_WARNING Section](#)
- [BSDLANno Header Comments](#)

BSDLANno Entity Declaration

The BSDLANno entity declaration is a VHDL construct that identifies the name of the device is described by the Boundary Scan Description Language (BSDL) file.

BSDLANno Generic Parameter

The BSDLANno generic parameter specifies which package is described by the Boundary Scan Description Language (BSDL) file.

Generic Parameter Example (xc5vlx30_ff324)

```
generic (PHYSICAL_PIN_MAP : string := "FF324" );
```

BSDLANno does not modify the generic parameter.

BSDLANno Logical Port Description

The BSDLANno logical port description:

- Lists all I/Os on a device
- States whether the pin is input, output, bidirectional, or unavailable for boundary scan

Pins configured as outputs are described as “inout” because the input boundary scan cell remains connected, even when the pin is used only as an output. Describing the output as “inout” reflects the actual boundary scan capability of the device and allows for greater test coverage.

Not all I/Os on the die are available (or bonded) in all packages. Unbonded I/Os are defined in the pre-configuration Boundary Scan Description Language (BSDL) file as “linkage” bits.

BSDLANno Logical Port Description Example

```
port (
AVDD_H10: linkage bit;
AVSS_H9: linkage bit;
CCLK_N8: inout bit;
CS_B_R16: in bit;
DONE_P8: inout bit;
DOUT_BUSY_T6: out bit;
D_IN_R7: in bit;
GND: linkage bit_vector (1 to 44);
HSWAP_EN_T17: in bit;
INIT_B_M8: inout bit;
```

BSDLANno modifies the logical port description to match the capabilities of the boundary scan circuitry after configuration. Modifications are made as follows:

- Dedicated pins (such as JTAG, mode, and done) are not modified. They are left as “inout bit.”
- Pins defined as bidirectional are left as “inout bit.”
- Pins defined as inputs are changed to “inout bit.”
- Pins defined as outputs are left as “inout bit.”
- Unused pins are not modified.
- The N-side of differential pairs is changed to “inout bit.”

Package Pin-Mapping

BSDLANno package pin-mapping shows how the pads on the device die are wired to the pins on the device package.

BSDLANno Package Pin-Mapping Example

```
"AVDD_H10:H10," &  
"AVSS_H9:H9," &  
"CCLK_N8:N8," &  
"CS_B_R16:R16," &  
"DONE_P8:P8," &  
"DOUT_BUSY_T6:T6," &  
"D_IN_R7:R7," &
```

BSDLANno does not modify the package pin-mapping.

BSDLANno USE Statement

The BSDLANno USE statement calls VHDL packages that contain attributes, types, and constants that are referenced in the Boundary Scan Description Language (BSDL) file.

Syntax

```
use vhdl_package ;
```

Example

```
use STD_1149_1_1994.all;
```

BSDLANno does not modify USE statements.

BSDLANno Scan Port Identification

The BSDLANno scan port identification identifies the following JTAG pins:

- TDI
- TDO
- TMS
- TCK
- TRST

TRST is an optional JTAG pin. TRST is not used by Xilinx® devices.

BSDLANno does not modify the Scan Port Identification.

BSDLANno Scan Port Identification Example

```
attribute TAP_SCAN_IN of TDI : signal is true;  
attribute TAP_SCAN_MODE of TMS : signal is true;  
attribute TAP_SCAN_OUT of TDO : signal is true;  
attribute TAP_SCAN_CLOCK of TCK : signal is (33.0e6, BOTH);
```

BSDLANno TAP Description

The BSDLANno TAP description provides additional information on the JTAG logic of a device. The TAP description includes:

- Instruction register length
- Instruction opcodes
- device IDCODE

These characteristics are device-specific, and may vary widely from device to device.

BSDLANno does not modify the TAP Description.

BSDLAnno TAP Description Example

```
-- Compliance-Enable Description

attribute COMPLIANCE_PATTERNS of test : entity is
    "(PROG_B) (1)";

-- Instruction Register Description

attribute INSTRUCTION_LENGTH of test : entity is 10;
```

BSDLAnno Boundary Register Description

The BSDLAnno boundary register description gives the structure of the boundary scan cells on the device. Each pin on a device may have up to three boundary scan cells, with each cell consisting of a register and a latch. Boundary scan test vectors are loaded into or scanned from these registers.

BSDLAnno Boundary Register Description Example

```
attribute BOUNDARY_REGISTER of test : entity is
-- cellnum (type, port, function, safel[, ccell, disval, disrslt])
" 0 (BC_1, *, internal, X)," &
" 1 (BC_1, *, internal, X)," &
" 2 (BC_1, *, internal, X)," &
" 3 (BC_1, *, internal, X)," &
" 4 (BC_1, *, internal, X)," &
" 5 (BC_1, *, internal, X)," &
" 6 (BC_1, *, internal, X)," &
```

Every IOB has three boundary scan registers associated with it:

- Control
- Output
- Input

BSDLAnno modifies the boundary register description as described in the [Boundary Scan Description Language \(BSDL\) File Modifications for Single-Ended Pins](#) and [Boundary Scan Description Language \(BSDL\) File Modifications for Differential Pins](#).

Boundary Scan Description Language (BSDL) File Modifications for Single-Ended Pins

This section discusses Boundary Scan Description Language (BSDL) file modifications for single-ended pins:

- [About Boundary Scan Description Language \(BSDL\) File Modifications for Single-Ended Pins](#)
- [BSDL File Single-Ended Tristate Output Pin Example](#)
- [BSDL File Single-Ended Input Pin Example](#)
- [BSDL File Single-Ended Output Pin Example](#)
- [BSDL File Unconfigured or Not Used Pin Example](#)

About Boundary Scan Description Language (BSDL) File Modifications for Single-Ended Pins

The only modification made to single-ended pins occurs when the pin is configured as an input. In this case, the boundary scan logic is disconnected from the output driver, and is unable to drive out on the pin. When a pin is configured as an output, the boundary scan input register remains connected to that pin. As a result, the boundary scan logic has the same capabilities as if the pin were configured as a bidirectional pin.

BSDL File Single-Ended Tristate Output Pin Example

If pin 57 has been configured as a single-ended tristate output pin, no code modifications are required.

```
-- TRISTATE OUTPUT PIN (three state output with an input component)
" 9 (BC_1, *, controlr, 1)," &
" 10 (BC_1, PAD57, output3, X, 9, 1, Z)," &
" 11 (BC_1, PAD57, input, X)," &
```

BSDL File Single-Ended Input Pin Example

If pin 57 is configured as a single-ended input, modify as follows:

```
-- PIN CONFIGURED AS AN INPUT
" 9 (BC_1, *, internal, 1)," &
" 10 (BC_1, *, internal, X)," &
" 11 (BC_1, PAD57, input, X)," &
```

BSDL File Single-Ended Output Pin Example

If pin 57 is configured as a single-ended output, it is treated as a single-ended bidirectional pin.

```
-- PIN CONFIGURED AS AN OUTPUT
" 9 (BC_1, *, controlr, 1)," &
" 10 (BC_1, PAD57, output3, X, 9, 1, Z)," &
" 11 (BC_1, PAD57, input, X)," &
```

BSDL File Unconfigured or Not Used Pin Example

If pin 57 is unconfigured or not used in the design, do not modify.

```
-- PIN CONFIGURED AS "UNUSED"
" 9 (BC_1, *, controlr, 1)," &
" 10 (BC_1, PAD57, output3, X, 9, 1, PULL0)," &
" 11 (BC_1, PAD57, input, X)," &
```

Boundary Scan Description Language (BSDL) File Modifications for Differential Pins

This section discusses Boundary Scan Description Language (BSDL) file modifications for differential pins:

- Boundary Scan Description Language (BSDL) File Modifications for Differential Pins
- BSDL File Differential Output, Differential Tristate Output, or Differential Bidirectional Pin Example
- BSDL File Differential P-Side Differential Input Pin Example
- BSDL File Differential N-Side Differential Input Pin Example

About Boundary Scan Description Language (BSDL) File Modifications for Differential Pins

All interactions with differential pin pairs are handled by the boundary scan cells connected to the P-side pin. To capture the value on a differential pair, scan the P-side input register. To drive a value on a differential pair, shift the value into the P-side output register. The values in the N-side scan registers have no effect on that pin.

Most boundary scan devices use only three boundary scan registers for each differential pair. Most devices do not offer direct boundary scan control over each individual pin, but rather over the two-pin pair. Since the two pins are transmitting only one bit of information, only one input, output, and control register is needed.

There are three boundary scan cells for each pin, or six registers for the differential pair. The N-side registers remain in the boundary scan register, but are not connected to the pin in any way. Because of this, the N-side registers are listed as *internal* registers in the post-configuration Boundary Scan Description Language (BSDL) file. The behavior of the N-side pin is controlled by the P-side boundary scan registers. For example, when a value is placed in the P-side output scan register, and the output is enabled, the inverse value is driven onto the N-side pin by the output driver. This is independent of the Boundary Scan logic.

BSDL File Differential Output, Differential Tristate Output, or Differential Bidirectional Pin Example

If pin 57 is configured as a differential output, differential tristate output, or differential bidirectional pin, modify as follows:

```
" 9 (BC_1, *, controlr, 1)," &
" 10 (BC_1, PAD57, output3, X, 9, 1, Z)," &
" 11 (BC_1, PAD57, input, X)," &
```

BSDL File Differential P-Side Differential Input Pin Example

If pin 57 is configured as a p-side differential input pin, modify as follows:

```
" 9 (BC_1, *, internal, 1)," &
" 10 (BC_1, *, internal, X)," &
" 11 (BC_1, PAD57, input, X)," &
```

BSDL File Differential N-Side Differential Input Pin Example

If pin 57 is configured as an n-side differential pin (all types: input, output, tristate output, and bidirectional), modify as follows:

```
" 9 (BC_1, *, internal, 1)," &
" 10 (BC_1, *, internal, X)," &
" 11 (BC_1, *, internal, X)," &
```

BSDLANno Modifications to the DESIGN_WARNING Section

BSDLANno adds the following DESIGN_WARNING to the Boundary Scan Description Language (BSDL) file:

```
This BSDL file has been modified to reflect post-configuration"&
behavior by BSDLANno. BSDLANno does not modify the USER1,"&
USER2, or USERCODE registers. For details on the features and"&
limitations of BSDLANno, please consult the Xilinx Development"&
System Reference Guide." ;
```

BSDLAAnno Header Comments

BSDLAAnno adds the following comments to the Boundary Scan Description Language (BSDL) file header:

- BSDLAAnno Post-Configuration File for design [*entity name*]
- BSDLAAnno [*BSDLAAnno version number*]

Boundary Scan Behavior in Xilinx Devices

Xilinx® Boundary Scan Description Language (BSDL) reflect the boundary scan behavior of an unconfigured device. After configuration, the boundary scan behavior of a device may change. I/O pins that were bidirectional before configuration may now be input-only. Since Boundary Scan test vectors are typically derived from BSDL files, if boundary scan tests are to be performed on a configured Xilinx device, modify the BSDL file to reflect the configured boundary scan behavior of the device.

Whenever possible, perform boundary scan tests on an unconfigured Xilinx device. Unconfigured devices allow for better test coverage, because all I/Os are available for bidirectional scan vectors.

In most cases, boundary scan tests with Xilinx devices must be performed after FPGA configuration only:

- When configuration cannot be prevented
- When differential signaling standards are used, unless the differential signals are located between Xilinx devices. In that case, both devices can be tested before configuration. Each side of the differential pair behaves as a single-ended signal.

PROMGen

This chapter describes PROMGen.

PROMGen Overview

PROMGen formats a BitGen-generated configuration bitstream (BIT) file into a PROM format file. The PROM file contains configuration data for the FPGA device. PROMGen converts a BIT file into one of several PROM or microprocessor-compatible formats (see [-p \(PROM Format\)](#) for details). The following diagram shows the inputs and the possible outputs of the PROMGen program:

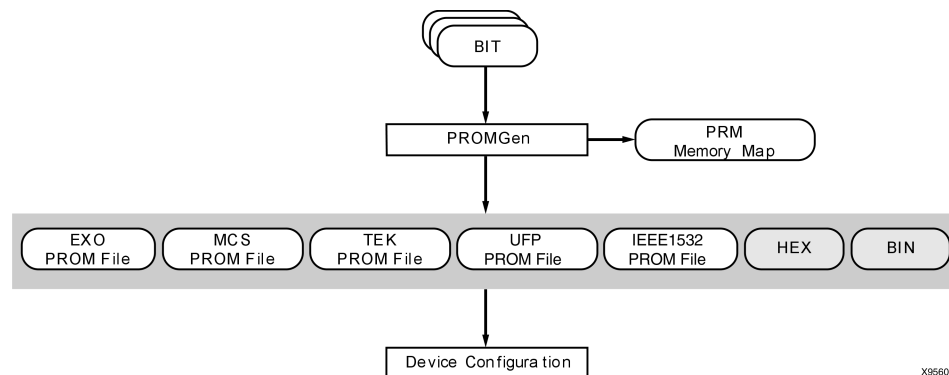

There are two functionally equivalent versions of PROMGen. There is a stand-alone version that you can access from an operating system prompt. There is also an interactive version, called the PROM formatting wizard that you can access from inside Project Navigator (see the iMPACT Help).

You can also use PROMGen to concatenate bitstream files to daisy-chain FPGAs.

Note If the destination PROM is one of the Xilinx Serial PROMs, you are using a Xilinx® PROM Programmer, and the FPGAs are not being daisy-chained, it is not necessary to make a PROM file.

PROMGen Device Support

This program is compatible with the following device families:

- 7 series
- Spartan®-3, Spartan-3A, Spartan-3E, and Spartan-6
- Virtex®-4, Virtex-5, and Virtex-6

PROMGen Input Files

The input to PROMGen consists of one or more of the following file types:

- **BIT** - Contains configuration data for an FPGA design.
- **ELF (MEM)** - Populates the Block RAMs specified in the .bmm file. This file is optional.
- **RBT (rawbits)** - Contains ASCII ones and zeros that represent the data in the bitstream file.

PROMGen Output Files

Output from PROMGen consists of the following files:

- **PROM files** - The file or files containing the PROM configuration information. See [-p \(PROM Format\)](#) for details.
- **PRM file** - The PRM file is a PROM image file. It contains a memory map of the output PROM file. The file has a .prm extension.
- **CFI file** - The CFI file is for use with xcfp prom.
- **SIG file** - The SIG file is for storage of the device signature for automatic signature programming.

PROMGen Syntax

To start PROMGen from the operating system prompt, use the following syntax:

```
promgen [ options ]
```

options can be any number of the options listed in [PROMGen Options](#). Enter options in any order, preceded them with a dash (minus sign on the keyboard) and separate them with spaces.

Note At least one of **-r**, **-u**, **-d**, or **-ver** must appear in the command.

PROMGen Options

This section describes the options that are available for the PROMGen command.

- **-b** (Disable Bit Swapping HEX Format Only)
- **-bd** (Specify Data File)
- **-bm** (Specify BMM File)
- **-bpi_dc** (Serial or Parallel Daisy Chaining)
- **-c** (Checksum)
- **-config_mode** (Configuration Mode)
- **-d** (Load Downward)
- **-data_file** (Add Data Files)
- **-data_width** (Specify PROM Data Width)
- **-f** (Execute Commands File)
- **-i** (Select Initial Version)
- **-intstyle** (Integration Style)
- **-l** (Disable Length Count)
- **-n** (Add BIT Files)
- **-o** (Output File Name)
- **-p** (PROM Format)
- **-r** (Load PROM File)
- **-s** (PROM Size)
- **-spi** (Disable Bit Swapping)
- **-t** (Template File)
- **-u** (Load Upward)
- **-ver** (Version)
- **-w** (Overwrite Existing Output File)
- **-x** (Specify Xilinx PROM)
- **-z** (Enable Compression)

-b (Disable Bit Swapping)

Disables bit swapping in all supported file types (MCS, EXO, TEK, UFP, IEEE1532, HEX, and BIN).

By default (no **-b** option), bits in the output files are swapped compared to bits in the input BIT files. If you use **-b**, the bits are not swapped. Bit swapping is described in [Bit Swapping in PROM Files](#).

Syntax

-b

-bd (Specify Data File)

This option specifies data files to be included in the output PROM file. Supported data file types are ELF and MEM. If no file type is specified, ELF is assumed.

Syntax

-bd *filename* [.elf|.mem] [*start hexaddress*]

Each data file may or may not have a start address. If a start address is specified, the data file is loaded starting at that address. If a start address is not specified, the data file is loaded at the end of the previous data file.

Note Data files are loaded up and not down. All memory size checks that apply to bit files also apply to data files. PROMGen checks to see if a given data file fits the specified location, just as it does for BIT files.

-bm (Specify BMM File)

This option specifies memory map (.bmm) files that supply particular bit/byte ordering for data files specified with the **-bd** option.

Syntax

```
-bm filename
```

-bpi_dc (Serial or Parallel Daisy Chaining)

This option selects serial or parallel daisy-chain output from the first FPGA connected in either BPI or SelectMAP modes.

Note Serial daisy-chain is not available for use with Spartan®-3 and Virtex®-4 devices.

Syntax

```
-bpi_dc serial|parallel
```

-c (Checksum)

This option generates a checksum value appearing in the .prm file. This value should match the checksum in the prom programmer. Use this option to verify that correct data was programmed into the prom.

Syntax

```
-c
```

-config_mode (Configuration Mode)

This option defines the size of the SelectMAP configuration data bus interface as 8, 16 or 32 bits.

Syntax

```
-config_mode selectmap8|selectmap16|selectmap32
```

-d (Load Downward)

This option loads one or more BIT files from the starting address in a downward direction. Specifying several files after this option causes the files to be concatenated in a daisy chain. You can specify multiple **-d** options to load files at different addresses. You must specify this option immediately before the input bitstream file.

Syntax

```
-d hexaddress0 filename filename
```

Here is the multiple file syntax:

```
promgen -d hexaddress0 filename filename
```

Here is the multiple `-d` options syntax:

```
promgen -d hexaddress1 filename -d hexaddress2 filename...
```

-data_file (Add Data Files)

This option specifies the direction, starting address, and data file names to add into the PROM file. These files will be added to the PROM as is, with no additional formatting.

Syntax

```
-data_file up|down hex_address file [ file ... ]
```

`up` specifies that the file should be loaded up from the specified address.

`down` specifies that the file should be loaded down from the specified address.

`hex_address` the hexadecimal starting address for loading the listed files.

`file` is a file to load. You can list more than one file. Separate files names by spaces. Files will be loaded in the order listed.

-data_width (Specify PROM Data Width)

This option specifies the data width of the PROM for which the output PROM file is being created. For example, `-data_width 8` specifies a byte-wide PROM.

Syntax

```
-data_width 8|16|32
```

Specifying a data width of 16 or 32 affects the output PROM file in two ways:

- Instructs PROMGen to expand the address space of the PROM by a factor of 2 or 4, based on a specified data width of 16 or 32.
- Instructs PROMGen to change the bit and byte order in the bitstreams to a pre-determined order for bitstreams belonging to Virtex®-4, Virtex-5, Virtex-6, Spartan®-6, and 7 series device families.

The default setting for the `-data_width` option is 8.

Note The expanded address space applies to bit files and data files. The reordering of bits and bytes applies only to certain bit files and does not apply to any data files.

The option values are available for architectures as shown below:

- `-data_width 8` is available for all supported FPGA architectures
- `-data_width 16` is available for Virtex-5, Virtex-6, Spartan-6, and 7 series devices
- `-data_width 32` is available for Virtex-4, Virtex-5, Virtex-6, Spartan-6, and 7 series devices

-f (Execute Commands File)

This option executes the command line arguments in the specified `command_file`.

Syntax

```
-f command_file
```

For more information on the **-f** option, see [-f \(Execute Commands File\)](#) in the Introduction chapter.

-i (Select Initial Version)

This option is used to specify the initial version for a Xilinx® multi-bank PROM.

Syntax

```
-i version
```

-intstyle (Integration Style)

This option limits screen output, based on the integration style that you are running, to warning and error messages only.

Syntax

```
-intstyle ise|xflow
```

When using **-intstyle**, one of three modes must be specified:

- **-intstyle ise** indicates the program is being run as part of an integrated design environment.
- **-intstyle xflow** indicates the program is being run as part of an integrated batch flow.

Note **-intstyle** is automatically invoked when running in an integrated environment such as Project Navigator or XFLOW.

-l (Disable Length Count)

This option disables the length counter in the FPGA bitstream. Use this option when chaining together bitstreams exceeding the 24 bit limit imposed by the length counter.

Syntax

```
-l
```

-n (Add BIT Files)

This option loads one or more BIT files up or down from the next available address following the previous load. The first **-n** option must follow a **-u** or **-d** option because **-n** does not establish a direction. Files specified with this option are not daisy-chained to previous files. Files are loaded in the direction established by the nearest prior **-d**, **-u**, or **-n** option.

Syntax

```
-n file1[.bit] file2[.bit]...
```

The following syntax shows how to specify multiple files. When you specify multiple files, PROMGen daisy-chains the files.

```
promgen -d hexaddress file0 -n file1 file2...
```

The syntax for using multiple **-n** options follows. Using this method prevents the files from being daisy-chained.

```
promgen -d hexaddress file0 -n file1 -n file2...
```

-o (Output File Name)

This option specifies the output file name of a PROM if it is different from the default. If you do not specify an output file name, the PROM file has the same name as the first BIT file loaded.

Syntax

```
-o file1[.ext] file2[.ext]
```

ext is the extension for the applicable PROM format.

Multiple file names may be specified to split the information into multiple files. If only one name is supplied for split PROM files (by you or by default), the output PROM files are named *file_#.ext*, where *file* is the base name, # is 0, 1, etc., and *ext* is the extension for the applicable PROM format.

```
promgen -d hexaddress file0 -o filename
```

-p (PROM Format)

This option sets the PROM format to MCS (Intel MCS86), EXO (Motorola EXORMAX), TEK (Tektronix TEKHEX), UFP (User Format PROM), or IEEE1532.

This option can also produce a HEX file (a hexadecimal representation of the configuration bitstream) or a BIN file (a binary representation of the configuration bitstream), which are used for microprocessor downloads.

Syntax

```
-p mcs|exo|tek|ufp|ieee1532|hex|bin
```

The default format is MCS.

IEEE1532 is a in-system programmability standard. The IEEE1532 compliant files that PROMGen produces have header and data formatted according to that standard.

For UFP (User Format PROM), you can define several parameters in the PROM File Template (PFT) file. Xilinx® provides a `default.pft` file in the `$XILINX/data` directory. You can control many parameters including byte order, bytes per word, the data separating character, etc.

-r (Load PROM File)

This option reads an existing PROM file as input instead of a BIT file. All of the PROMGen output options may be used, so the `-r` option can be used for splitting an existing PROM file into multiple PROM files or for converting an existing PROM file to another format.

Syntax

```
-r promfile
```

Note You cannot use `-d`, `-u`, or `-n` if you use `-r`.

-s (PROM Size)

This option sets the PROM size in kilobytes. The PROM size must be a power of 2. The default value is 64 kilobytes. The `-s` option must precede any `-u`, `-d`, or `-n` options.

Syntax

```
-s promsize1 [ promsize2 ... ]
```

Multiple *promsize* entries for the **-s** option indicates the PROM will be split into multiple PROM files.

Note Use the software tools to set all PROMs of the chain, create the PROM file, and check how these options are used by opening the PRM report generated.

-spi (Disable Bit Swapping)

This option disables bit swapping for compatibility with SPI flash devices.

Syntax

```
-spi
```

-t (Template File)

This option specifies a template file for the user format PROM (UFP). If unspecified, the default file `$XILINX/data/default.pft` is used. If the UFP format is selected, the **-t** option is used to specify a control file.

Syntax

```
-t templatefile.pft
```

-u (Load Upward)

This option loads one or more BIT files from the starting address in an upward direction. When you specify several files after this option, PROMGen concatenates the files in a daisy chain. You can load files at different addresses by specifying multiple **-u** options.

Syntax

```
-u hexaddress0 filename1 filename2...
```

This option must be specified immediately before the input bitstream file.

-ver (Version)

This option loads `.bit` files from the specified hexaddress. Multiple `.bit` files daisychain to form a single PROM load. The daisychain is assigned to the specified version within the PROM.

Note This option is only valid for Xilinx® multibank PROMs.

Syntax

```
-ver [version] hexaddress filename1.bit filename2.bit...
```

-w (Overwrite Existing Output File)

This option overwrites an existing output file, and must be used if an output file exists. If this option is not used, PROMGen issues an error.

Syntax

```
-w
```

-x (Specify Xilinx PROM)

This option specifies one or more Xilinx® serial PROMs for which the PROM files are targeted. Use this option instead of the **-s** option if you know the Xilinx PROMs to use.

Syntax

```
-x xilinx_prom1 [ xilinx_prom2 ... ]
```

Multiple *xilinx_prom* entries for the **-x** option indicates the PROM will be split into multiple PROM files.

Note Use the software tools to set all PROMs of the chain, create the PROM file, and check how these options are used by opening the PRM report generated.

-z (Enable Compression)

This option enables compression for a Xilinx® multi-bank PROM. All PROM versions will be compressed if *version* is not specified.

Syntax

```
-z version
```

Bit Swapping in PROM Files

PROMGen produces a PROM file in which the bits within a byte are swapped compared to the bits in the input BIT file. Bit swapping (also called bit mirroring) reverses the bits within each byte, as shown in the following diagram:

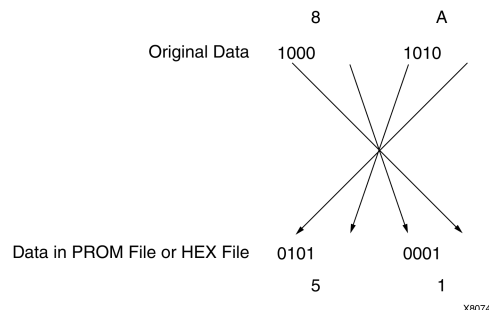

In a bitstream contained in a BIT file, the Least Significant Bit (LSB) is always on the left side of a byte. But when a PROM programmer or a microprocessor reads a data byte, it identifies the LSB on the right side of the byte. In order for the PROM programmer or microprocessor to read the bitstream correctly, the bits in each byte must first be swapped so they are read in the correct order.

In this release of the ISE® Design Suite, the bits are swapped for all of the output formats: MCS, EXO, TEK, UFP, IEEE1532, HEX, and BIN. Bit swapping is on by default but can be turned off for any output format by using the **-b (Disable Bit Swapping)** PROMGen option.

PROMGen Examples

Loading a File Up

To load the file `test.bit` up from address `0x0000` in MCS format, enter the following information at the command line:

```
promgen -u 0 test
```

Daisy-chaining Files

To daisy-chain the files `test1.bit` and `test2.bit` up from address `0x0000` and the files `test3.bit` and `test4.bit` from address `0x4000` while using a 32K PROM and the Motorola EXORmax format, enter the following information at the command line:

```
promgen -s 32 -p exo -u 00 test1 test2 -u 4000 test3 test4
```

Loading a File in a Downward Direction

To load the file `test.bit` into the PROM programmer in a downward direction starting at address `0x400`, using a Xilinx® XC1718D PROM, enter the following information at the command line:

```
promgen -x xc1718d -u 0 test
```

Specifying a Non-default File Name

To specify a PROM file name that is different from the default file name enter the following information at the command line:

```
promgen options filename -o newfilename
```

IBISWriter

This chapter describes the IBISWriter program.

IBISWriter Overview

The Input/Output Buffer Information Specification (IBIS) is a device modeling standard. IBIS allows for the development of behavioral models used to describe the signal behavior of device interconnects. These models preserve proprietary circuit information, unlike structural models such as those generated from SPICE (Simulation Program with Integrated Circuit Emphasis) simulations. IBIS buffer models are based on V/I curve data produced either by measurement or by circuit simulation.

IBIS models are constructed for each IOB standard, and an IBIS file is a collection of IBIS models for all I/O standards in the device. An IBIS file also contains a list of the used pins on a device that are bonded to IOBs configured to support a particular I/O standard (which associates the pins with a particular IBIS buffer model).

IBISWriter supports the use of digitally controlled impedance (DCI) with reference resistance that is selected by the user. Although it is not feasible to have IBIS models available for every possible user input, IBIS models are available for I/O Standards LVCMOS15 through LVCMOS33 for impedances of 40, 50, and 65 ohms. If not specified, the default impedance value is 50 ohms.

The IBIS standard specifies the format of the output information file, which contains a file header section and a component description section. The Golden Parser has been developed by the IBIS Open Forum Group (<http://www.eda.org/ibis/>) to validate the resulting IBIS model file by verifying that the syntax conforms to the IBIS data format.

The IBISWriter tool requires a design source file as input. For FPGA designs, this is a physical description of the design in the form of a Native Circuit Description (NCD) file with a .ncd file extension. For CPLD designs, the input is produced by CPLDFit and has a .pnx file extension.

IBISWriter outputs a .ibs file. This file comprises a list of pins used by your design; the signals internal to the device that connect to those pins; and the IBIS buffer models for the IOBs connected to the pins.

IBISWriter Flow

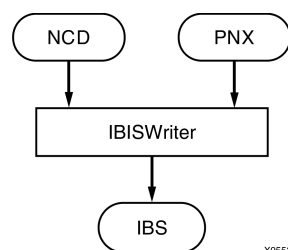

IBISWriter Device Support

This program is compatible with the following device families:

- 7 series
- Spartan®-3, Spartan-3A, Spartan-3E, and Spartan-6
- Virtex®-4, Virtex-5, and Virtex-6
- CoolRunner™ XPLA3 and CoolRunner-II
- XC9500 and XC9500XL

IBISWriter Input Files

IBISWriter requires a design source file as input.

- FPGA Designs
Requires a physical description of the design in the form of an NCD file with a .ncd file extension.
- CPLD Designs
The input is produced by CPLDFit and has a .pnx file extension.

IBISWriter Output Files

IBISWriter outputs a .ibs ASCII file. This file comprises a list of package pins used by your design, the signals internal to the device that connect to those pins, and the IBIS buffer models for the IOBs connected to the pins. The format of the IBIS output file is determined by the IBIS standard. IBISWriter conforms to either version 3.2 or 4.2 of this specification. In the event that an IBISWriter error occurs, in most cases it continues through the entire design, listing any other errors encountered, then exits without creating the .ibs output file. This error reporting helps you identify problems and make corrections before running the program again.

Note IBISWriter gives an error message if a pin with an I/O Standard for which no buffer is available is encountered, or if a DCI value property is found for which no buffer model is available. This happens when the I/O standard model is not yet available in the installed ISE® Design Suite version. The design signals are still listed in the output file and assigned to NC (Not Connected). You can update to the latest version of ISE Design Suite then rerun IBISWriter. Expert users can modify the output file and assign these signals to an existing or new model.

IBISWriter Syntax

Use the following syntax to run IBISWriter from the command line:

```
ibiswriter [options] infile outfile[.ibs]
```

- *options* is one or more of the options listed in [IBISWriter Options](#). Enter options in any order, preceded them with a dash (minus sign on the keyboard) and separate them with spaces.
- *infile* is the design source file for the specified design. For FPGA designs, *infile* must have a .ncd extension. For CPLD designs, *infile* is produced by the CPLDFit and must have a .pnx extension.
- *outfile* is the destination for the design specific IBIS file. The .ibs extension is optional. The length of the IBIS file name, including the .ibs extension, cannot exceed 24 characters.

IBISWriter Options

This section provides information on IBISWriter command line options.

- [-allmodels](#) (Include all available buffer models for this architecture)
- [-g](#) (Set Reference Voltage)
- [-intstyle](#) (Integration Style)
- [-pin](#) (Generate Detailed Per-Pin Package Parasitics) – Obsolete (now the default)
- [-nopin](#) (Disable Inclusion of Per-pin Modeling of the Package)
- [-truncate](#) (Specify Maximum Length for Signal Names in Output File)
- [-vccaux](#) (Set vccaux Voltage)

-allmodels (Include all available buffer models for this architecture)

To reduce the size of the output `.ibs` file, IBISWriter produces an output file that contains only design-specific buffer models, as determined from the active pin list. To access all available buffer models, use the `-allmodels` option.

Syntax

```
-allmodels
```

-g (Set Reference Voltage)

Supported architectures and option values are shown below.

Architecture	Option	Value	Description
XC9500	VCCIO	LVTTL, TTL	Use this option to configure I/Os for 3.3V (LVTTL) or 5V (TTL) VCCIO reference voltage. The <code>-g</code> option is required.
XC9500XL	VCCIO	LVC MOS2, LVTTL	Use this option to configure outputs for 3.3V (LVTTL) or 2.5V (LVC MOS2) VCCIO reference voltage. Each user pin is compatible with 5V, 3.3V, and 2.5V inputs. The <code>-g</code> option is required.

Syntax

```
-g option_value_pair
```

Example using the VCCIO:LVTTL option value pair

```
-g VCCIO:LVTTL design.ncd design.ibs
```

-intstyle (Integration Style)

This option limits screen output, based on the integration style that you are running, to warning and error messages only.

Syntax

```
-intstyle ise|xflow|silent
```

When using `-intstyle`, one of three modes must be specified:

- `-intstyle ise` indicates the program is being run as part of an integrated design environment.
- `-intstyle xflow` indicates the program is being run as part of an integrated batch flow.
- `-intstyle silent` limits screen output to warning and error messages only.

Note `-intstyle` is automatically invoked when running in an integrated environment such as Project Navigator or XFLOW.

-nopin (Disable Inclusion of Per-pin Modeling of the Package)

When you use this option, the package is reduced to a single RLC transmission line model applied to all pins and defined in the [Package] section. By default, IBISWriter includes per-pin modeling of the package as RLC matrices in the [Define Package Model] section if this data is available.

Syntax

`-nopin`

By default, this option is not set (per-pin modeling is included).

-truncate (Specify Maximum Length for Signal Names in Output File)

This option specifies the maximum length for signal names in the generated models.

From an initial limit of 20 characters, the IBIS specification has evolved over time to now accept 40 characters. Adjust this setting depending on the version supported by the signal integrity simulator. By default IBISWriter will truncate signals to 20 characters in accordance with the IBIS version 3.2 specification. IBISWriter will ensure uniqueness of signal names. For instance it preserves indexes for each element of a bus.

Syntax

`-truncate [20 | 40 | no]`

20 (the default) limits signal names to 20 characters.

40 limits signal names to 40 characters.

no allows unlimited signal name length.

-vccaux (Specify VCCAUX Voltage Level)

This option specifies the voltage applied to the VCCAUX voltage supply for families which accept multiple voltages.

Note This option is supported only by Spartan®-3A, Spartan-3A DSP, and Spartan-6 devices.

Syntax

`-vccaux [2.5 | 3.3 | 25 | 33]`

The default value is 2.5

CPLDFit

This chapter describes CPLDFit.

CPLDFit Overview

The CPLDFit program is a command line executable that takes a Native Generic Database (NGD) file, produced by NGDBuild, as input and fits the design into a CPLD device.

CPLDFit Design Flow

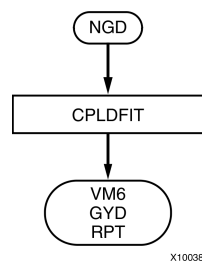

CPLDFit Device Support

This program is compatible with the following device families:

- CoolRunner™ XPLA3 and CoolRunner-II
- XC9500 and XC9500XL

CPLDFit Input Files

CPLDFit takes the following file as input:

NGD file - Native Generic Database (NGD) file output by NGDBuild. This file contains a logical description of the design expressed both in terms of the hierarchy used when the design was first created and in terms of lower-level Xilinx® primitives to which the hierarchy resolves.

CPLDFit Output Files

CPLDFit outputs the following files:

- **VM6 file** - This file is the default output file from CPLDFit and the input file to the Hprep6 and TAEngine programs. See the [Hprep6 chapter](#) and [TAEngine chapter](#) for more information.
- **GYD file** - This file is the optional guide file generated by CPLDFit, which contains pin freeze information as well as the placement of internal equations from the last successful fit.
- **RPT file** - This file is the CPLDFit report file, which contains a resource summary, implemented equations, device pinout as well as the compiler options used by CPLDFit.
- **XML file** - This file is used to generate an HTML report.
- **PNX file** - This file is used by the [IBISWriter program](#) to generate an IBIS model for the implemented design.
- **CXT file** - This file is used by the XPWR program to calculate and display power consumption.
- **MFD file** - This file is used by HTML Reports to generate a graphical representation of the design implementation.

CPLDFit Syntax

Following is the command line syntax for running the CPLDFit program:

```
cpldfit infile .ngd [options]
```

infile.ngd is the name of the input NGD file.

options can be any number of the CPLDFit options listed in [CPLDFit Options](#). Enter options in any order, preceded them with a dash (minus sign on the keyboard) and separate them with spaces.

CPLDFit Options

CPLDFit uses the following options:

- `-blkfanin` (Specify Maximum Fanin for Function Blocks)
- `-exhaust` (Enable Exhaustive Fitting)
- `-ignoredatagate` (Ignore DATA_GATE Attributes)
- `-ignoretspec` (Ignore Timing Specifications)
- `-init` (Set Power Up Value)
- `-inputs` (Number of Inputs to Use During Optimization)
- `-iostd` (Specify I/O Standard)
- `-keepio` (Prevent Optimization of Unused Inputs)
- `-loc` (Keep Specified Location Constraints)
- `-localfbk` (Use Local Feedback)
- `-log` (Specify Log File)
- `-nofbnand` (Disable Use of Foldback NANDS)
- `-nogckopt` (Disable Global Clock Optimization)
- `-nogsropt` (Disable Global Set/Reset Optimization)
- `-nogtsopt` (Disable Global Output-Enable Optimization)
- `-noisp` (Turn Off Reserving ISP Pin)
- `-nomlopt` (Disable Multi-level Logic Optimization)
- `-nouim` (Disable FASTConnect/UIM Optimization)
- `-ofmt` (Specify Output Format)
- `-optimize` (Optimize Logic for Density or Speed)
- `-p` (Specify Xilinx Part)
- `-pinfbk` (Use Pin Feedback)
- `-power` (Set Power Mode)
- `-pterm`s (Number of Pterms to Use During Optimization)
- `-slew` (Set Slew Rate)
- `-terminate` (Set to Termination Mode)
- `-unused` (Set Termination Mode of Unused I/Os)
- `-wysiwyg` (Do Not Perform Optimization)

Note Options apply to all CPLD families except where specified.

-blkfanin (Specify Maximum Fanin for Function Blocks)

This option specifies the maximum number of function block inputs to use when fitting a device. If the value is near the maximum, this option reduces the possibility that design revisions will be able to fit without changing the pinout.

Syntax

```
-blkfanin [ limit:4,40 ]
```

The maximum values vary with each supported CPLD architecture (default in parentheses).

- CoolRunner™ XPLA3 = 40 (38)
- CoolRunner-II = 40 (36)

-exhaust (Enable Exhaustive Fitting)

The values for inputs and pterms have an impact on design fitting. Occasionally different values must be tried before a design is optimally fit. This option automates this process by iterating through all combinations of input and pterm limits until a fit is found. This process can take several hours depending on the size of the design. This option is off by default.

Architecture Support: CoolRunner™ XPLA3 and CoolRunner-II

Syntax

```
-exhaust
```

-ignoredatagate (Ignore DATA_GATE Attributes)

This option directs CPLDFit to ignore the DATA_GATE attribute when fitting a CoolRunner™-II device. This option is off by default.

Architecture Support: CoolRunner-II

Syntax

```
-ignoredatagate
```

-ignoretspec (Ignore Timing Specifications)

CPLDFit optimizes paths to meet timing constraints. This option directs CPLDFit to *not* perform this prioritized optimization. This option is off by default.

Syntax

```
-ignoretspec
```

-init (Set Power Up Value)

This option specifies the default power up state of all registers. This option is overridden if an INIT attribute is explicitly placed on a register. Low and high are self-explanatory. The FPGA setting causes all registers with an asynchronous reset to power up low, all registers with an asynchronous preset to power up high, and remaining registers to power up low. The default setting is low.

Syntax

```
-init [low|high|fpga]
```

-inputs (Number of Inputs to Use During Optimization)

This option specifies the maximum number of inputs for a single equation. The higher this value, the more resources a single equation may use, possibly limiting the number of equations allowed in a single function block.

Syntax

```
-inputs [limit]
```

The maximum limit varies with each CPLD architecture. The limits are as follows (default in parentheses):

- XC9500 = 2,36 (36)
- XC9500XL = 2,54 (54)
- CoolRunner™ XPLA3 = 2,40 (36)
- CoolRunner-II = 2,40 (36)

-iostd (Specify I/O Standard)

This option sets the default voltage standard for all I/Os. The default is overridden by explicit assignments.

Note This option applies only to CoolRunner™-II devices.

Syntax

`-iostd voltage_standard`

voltage_standard is the name of the voltage standard to assign to I/Os. Valid values are LVTTL, LVCMOS18, LVCMOS18_ALL, LVCMOS25, LVCMOS33, SSTL2_I, SSTL3_I, HSTL_I, and LVCMOS15. The default is LVCMOS18.

-keepio (Prevent Optimization of Unused Inputs)

This option prevents unused inputs from being optimized. By default, CPLDFit trims unconnected input pins.

Note Other devices support multiple I/O standards, but do not require special software settings.

Syntax

`-keepio`

-loc (Keep Specified Location Constraints)

This option specifies how CPLDFit uses the design location constraints.

Syntax

`-loc [on|off|try]`

on (the default) directs CPLDFit to obey location constraints.

off directs CPLDFit to ignore location constraints.

try directs CPLDFit to use location constraints unless doing so would result in a fitting failure.

-localfbk (Use Local Feedback)

The XC9500 macrocell contains a local feedback path. This option turns this feedback path on. This option is off by default.

Architecture Support: XC9500

Syntax

`-localfbk`

-log (Specify Log File)

This option generates a log file that contains all error, warning, and informational messages.

Syntax

```
-log logfile
```

-nofbnd (Disable Use of Foldback NANDs)

This option disables the use of the foldback NAND when fitting the design. This option is off by default.

Architecture Support: CoolRunner™ XPLA3

Syntax

```
-nofbnd
```

-nogclkopt (Disable Global Clock Optimization)

This option turns off automatic global clock inferring, and is off by default.

Syntax

```
-nogclkopt
```

-nogsropt (Disable Global Set/Reset Optimization)

This option turns off automatic global set/reset inferring. If this option is off, global buffers must be declared in the UCF or by direct instantiation in the HDL or schematic.

Syntax

```
-nogsropt
```

-nogtsopt (Disable Global Output-Enable Optimization)

This option turns off automatic global tristate inferring. If this option is off, global buffers must be declared in the UCF or by direct instantiation in the HDL or schematic.

Syntax

```
-nogtsopt
```

-noisp (Turn Off Reserving ISP Pin)

This option disables the JTAG pins, allowing them to be used as I/O pins. This option is off by default.

Architecture Support: CoolRunner™ XPLA3

Syntax

```
-noisp
```

-nomlopt (Disable Multi-level Logic Optimization)

This option disables multi-level logic optimization when fitting a design. This option is off by default.

Syntax

```
-nomlopt
```

-nouim (Disable FASTConnect/UIM Optimization)

The XC9500 interconnect matrix allows multiple signals to be joined together to form a wired AND functionality. This option turns this functionality off. This option is off by default.

Architecture Support: XC9500

Syntax

```
-nouim
```

-ofmt (Specify Output Format)

This option sets the language used in the fitter report when describing implemented equations.

Syntax

```
-ofmt [vhdl|verilog]
```

-optimize (Optimize Logic for Density or Speed)

This option directs CPLDFit to optimize the design for density or speed. Optimizing for density may result in slower operating frequency but uses resource sharing to allow more logic to fit into a device. Optimizing for speed uses less resource sharing but flattens the logic, which results in fewer levels of logic (higher operating frequency). Density is the default argument for this option.

Syntax

```
-optimize density|speed
```

-p (Part Number)

This option specifies the part into which your design is implemented.

Syntax

```
-p part_number
```

part_number is in the form of device-speedgrade-package (for example, XC2C512-10-FT256). If a device is a lead-free package, it will have a G suffix in the package name. For Example: XC2C512-10-FTG256. From a software perspective, lead-free versus regular packages are identical so when specifying the package type, omit the G suffix.

If only a product family is entered (for example, XPLA3), CPLDFit iterates through all densities in that family until a fit is found.

-pinfbk (Use Pin Feedback)

The XC9500 architecture allows feedback into the device through the I/O pin. This option turns this feedback functionality on. This option is on by default.

Architecture Support: XC9500

Syntax

```
-pinfbk
```

-power (Set Power Mode)

This option sets the default power mode of macrocells. This option can be overridden if a macrocell is explicitly assigned a power setting.

Note This option is available for XC9500/XL/XV devices.

Syntax

```
-power [std|low|auto]
```

std (the default) is used for standard high speed mode.

low is used for low power mode (at the expense of speed).

auto allows CPLDFit to choose the std or low setting based on the timing constraints.

-pters (Number of Pterms to Use During Optimization)

This option specifies the maximum number of product terms for a single equation. The higher this value, the more product term resources a single equation may use, possibly limiting the number of equations allowed in a single function block. The maximum limit varies with each CPLD architecture.

Syntax

```
-pters [limit:1,90]
```

The limits are as follows (default in parenthesis):

- XC9500 = 90 (25)
- XC9500XL = 90 (25)
- CoolRunner™ XPLA3 = 48 (36)
- CoolRunner-II = 56 (36)

-slew (Set Slew Rate)

This option specifies the default slew rate for output pins. Fast and slow are self-explanatory. The auto setting allows CPLDFit to choose which slew rate to use based on the timing constraints. The default setting is fast.

Syntax

```
-slew [fast|slow|auto]
```

-terminate (Set to Termination Mode)

This option globally sets all inputs and tristate outputs to the specified form of termination. Not all termination modes exist for each architecture.

Syntax

-terminate [pullup|keeper|float]

The available modes for each architecture follow (default in parentheses):

- XC9500XL devices: Float, Keeper (keeper)
- CoolRunner™ XPLA3 devices: Float, Pullup (pullup)
- CoolRunner-II devices: Float, Pullup, Keeper, Pulldown (float)

-unused (Set Termination Mode of Unused I/Os)

This option specifies how unused pins are terminated. Not all options are available for all architectures.

Syntax

-unused [ground|pulldown|pullup|keeper|float]

The allowable options follow (default in parentheses):

- XC9500XL devices: Float, Ground (float)
- CoolRunner™ XPLA3 devices: Float, Pullup (pullup)
- CoolRunner-II devices: Float, Ground, Pullup, Keeper, Pulldown (ground)

-wysiwyg (Do Not Perform Optimization)

This option directs CPLDFit to not perform any optimization on the design provided to it. This option is off by default.

Syntax

-wysiwyg

TSIM

This chapter describes the TSIM program.

TSIM Overview

The TSIM program is a command line executable that takes an implemented CPLD design file (VM6) as input and outputs an annotated NGA file used by the NetGen program. The NetGen Timing Simulation flow produces a back-annotated timing netlist for timing simulation. See the CPLD Timing Simulation section in the NetGen chapter for more information.

TSIM Device Support

This program is compatible with the following device families:

- CoolRunner™ XPLA3 and CoolRunner-II
- XC9500 and XC9500XL

TSIM Input Files

TSIM uses a VM6 file as input. This is a database file, output by CPLDFit, that contains the mapping of the user design into the target CPLD architecture.

TSIM Output Files

TSIM outputs an NGA file. This back-annotated logical design file is used as an input file for the NetGen Timing Simulation flow.

TSIM Syntax

Following is the syntax for the TSIM command line program:

```
tsim design.vm6 output.nga
```

design.vm6 is the name of the input design file (VM6) output by the CPLDFit program. See the CPLDFit chapter for more information.

output.nga is the name of the output file for use with the NetGen Timing Simulation flow to create a back-annotated netlist for timing simulation. If an output file name is not specified, TSIM uses the root name of the input design file with a .nga extension.

TAEngine

This chapter describes the Timing Analysis Engine (TAEngine) program. TAEngine is a command line executable that performs static timing analysis on implemented Xilinx® CPLD designs.

TAEngine Overview

TAEngine takes an implemented CPLD design file (VM6) from CPLDFit and performs a static timing analysis of the timing components. The results of the static timing analysis are written to a TAEngine report file (TIM) in summary or detail format.

The default output for TAEngine is a TIM report in summary format, which lists all timing paths and their delays. A detailed TIM report, specified with the `-detail` ([Detail Report](#)) option, lists all timing paths and a summary of all individual timing components in each path. Both the summary TIM report and the detailed TIM report show the performance of all timing constraints contained in the design.

TAEngine Design Flow

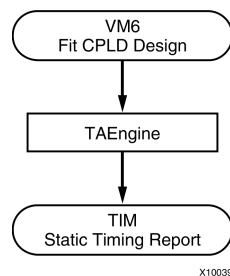

TAEngine Device Support

This program is compatible with the following device families:

- CoolRunner™ XPLA3 and CoolRunner-II
- XC9500 and XC9500XL

TAEngine Input File

TAEngine takes the following file as input:

VM6 -An implemented CPLD design produced by the CPLDFit program.

TAEngine Output File

TAEngine outputs the following file:

TIM file - An ASCII (text) timing report file with a `.tim` extension that lists the timing paths and performance to timing constraints contained in the design. This report file can be produced in summary (default) or detail format.

TAEngine Syntax

Following is the command line syntax for running TAEngine:

```
taengine -f design_name.vm6 [options]
```

-f *design_name*.vm6 specifies the name of the VM6 design file

options can be any number of the TAEngine options listed in [TAEngine Options](#). Enter options in any order, preceded them with a dash (minus sign on the keyboard) and separate them with spaces.

TAEngine Options

This section describes the TAEngine command line options.

- [-detail \(Detail Report\)](#)
- [-iopath \(Trace Paths\)](#)
- [-l \(Specify Output Filename\)](#)

-detail (Detail Report)

This option is used to produce a detail formatted TAEngine report (TIM) that shows static timing analysis for all paths in the design, as well as details for the delays in each path.

Syntax

```
-detail
```

-iopath (Trace Paths)

This option instructs TAEngine to trace paths through bi-directional pins.

Syntax

```
-iopath
```

-l (Specify Output Filename)

The **-l** option specifies the name of the output report file. By default, TAEngine takes the root name of the input design file and adds a `.tim` extension (*design_name.tim*).

Syntax

```
-l output_file.tim
```

Hprep6

This chapter describes the Hprep6 program. Hprep6 is a command line executable that takes an implemented CPLD design file (VM6) as input and generates a programming file for configuring a Xilinx® CPLD device.

Hprep6 Overview

Hprep6 takes an implemented CPLD design file (VM6) from the CPLDFit program and generates a programming file for downloading to a CPLD device. Program files are generated in JEDEC (JED) format and optionally ISC format based on options specified on the command line.

Hprep6 Design Flow

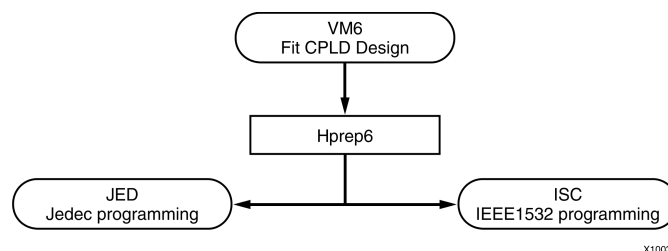

Hprep6 Device Support

This program is compatible with the following device families:

- CoolRunner™ XPLA3 and CoolRunner-II
- XC9500 and XC9500XL

Hprep6 Syntax

Following is the command line syntax for running the Hprep6 program:

```
hprep6 -i design_name .vm6 [options]
```

-i design_name.vm6 specifies the name of the input design file, and is required.

options can be any number of the Hprep6 options listed in the [Hprep6 Options](#) section of this chapter. Enter options in any order, preceded them with a dash (minus sign on the keyboard) and separate them with spaces.

Hprep6 Input Files

Hprep6 uses the following file as input:

VM6 - An implemented CPLD design file from the CPLDFit utility. See the CPLDFit chapter for additional information.

Hprep6 Output Files

Hprep6 outputs the following files:

- **JED file** - A JEDEC file used for CPLD programming
- **ISC file** - A IEEE1532 file used for CPLD programming

Hprep6 Options

This section describes the Hprep6 command line options.

- **-autosig** (Automatically Generate Signature)
- **-intstyle** (Integration Style)
- **-n** (Specify Signature Value for Readback)
- **-nopullup** (Disable Pullups)
- **-s** (Produce ISC File)
- **-tmv** (Specify Test Vector File)

-autosig (Automatically Generate Signature)

This option inserts an automatically generated pattern-specific signature in the JEDEC file. This signature can be automatically programmed into the target devices USERCODE register by the iMPACT configuration software. **-autosig** is ignored if you use **-n signature**.

Syntax

```
-autosig
```

-intstyle (Integration Style)

This option limits screen output, based on the integration style that you are running, to warning and error messages only.

Syntax

```
-intstyle ise|xflow|silent
```

When using **-intstyle**, one of three modes must be specified:

- **-intstyle ise** indicates the program is being run as part of an integrated design environment.
- **-intstyle xflow** indicates the program is being run as part of an integrated batch flow.
- **-intstyle silent** limits screen output to warning and error messages only.

Note **-intstyle** is automatically invoked when running in an integrated environment such as Project Navigator or XFLOW.

-n (Specify Signature Value for Readback)

This option is applicable to the XC9500/XL devices only. The value entered in the signature field programs a set of bits in the CPLD that may be read-back via JTAG after programming. This is often used as to identify the version of a design programmed into a device.

Note The CoolRunner™ family also allows for a signature value, but it must be entered by the programming tool (for instance, iMPACT or third party programmer).

Syntax

```
-n [signature]
```

-nopullup (Disable Pullups)

This option instructs Hprep6 to disable the pullups on empty function blocks. By default, pullups are enabled to minimize leakage current and prevent floating I/Os.

Note The `-nopullup` option applies to XC9500/XL devices only.

Syntax

```
-nopullup
```

-s (Produce ISC File)

This option instructs Hprep6 to output an additional programming file in IEEE1532 format (ISC). This file will be named `design_name.isc`.

Note ISC IEEE532 output is not available for the CoolRunner™ XPLA3 family.

Syntax

```
-s IEEE1532
```

-tmv (Specify Test Vector File)

This option is used to specify a test vector file for use with the iMPACT tool functional test operation. The TMV file is in ABEL format and embeds test vectors into the end for the JEDEC programming file.

Note This option is available for XC9500/XL devices only.

Syntax

```
-tmv filename
```

XFLOW

This chapter describes the XFLOW program, a scripting tool that lets you automate implementation, simulation, and synthesis flows using Xilinx® programs.

XFLOW Overview

XFLOW is a Xilinx® command line program that automates Xilinx synthesis, implementation, and simulation flows. XFLOW reads a design file as input as well as a flow file and an option file. Xilinx provides a default set of flow files that automate which Xilinx programs are run to achieve a specific design flow. For example, a flow file can specify that NGDDBuild, MAP, PAR, and TRACE are run to achieve an implementation flow for an FPGA. You can use the default set of flow files as is, or you can customize them. See [XFLOW Flow Types](#) and [Flow Files](#) for more information. Option files specify which command line options are run for each of the programs listed in the flow file. You can use the default set of option files provided by Xilinx, or you can create your own option files. See [XFLOW Options](#) for more information.

The following figure shows the inputs and the possible outputs of the XFLOW program. The output files depend on the flow you run.

XFLOW Design Flow

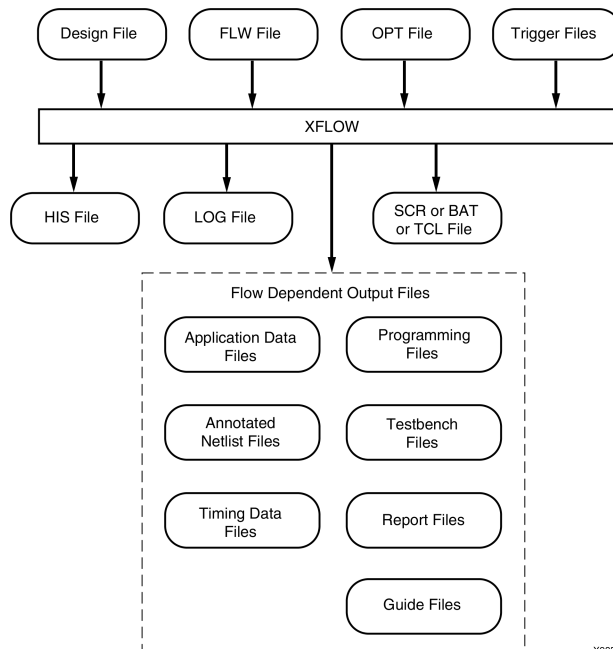

X9859

XFLOW Device Support

This program is compatible with the following device families:

- 7 series
- Spartan®-3, Spartan-3A, Spartan-3E, and Spartan-6
- Virtex®-4, Virtex-5, and Virtex-6
- CoolRunner™ XPLA3 and CoolRunner-II
- XC9500 and XC9500XL

XFLOW Input Files

XFLOW uses the following files as input:

Design File (for non-synthesis flows) - For all flow types except **-synth**, the input design can be an EDIF 2 0 0, or NGC (XST output) netlist file. You can also specify an NGD, NGO, or NCD file if you want to start at an intermediate point in the flow. XFLOW recognizes and processes files with the extensions shown in the following table.

File Type	Recognized Extensions
EDIF	.sedif, .edn, .edf, .edif
NCD	.ncd
NGC	.ngc
NGD	.ngd
NGO	.ngo

Design File (for synthesis flows) - For the **-synth** flow type, the input design can be a Verilog or VHDL file. If you have multiple VHDL or Verilog files, you can use a PRJ or V file that references these files as input to XFLOW. For information on creating a PRJ or V file, see the *XST User Guide for Virtex-4, Virtex-5, Spartan-3, and Newer CPLD Devices (UG627)* or the *XST User Guide for Virtex-6, Spartan-6, and 7 Series Devices (UG687)*. You can also use existing PRJ files generated while using Project Navigator. XFLOW recognizes and processes files with the extensions shown in the following table.

File Type	Recognized Extensions
PRJ	.prj
Verilog	.v
VHDL	.vhd

Note You must use the **-g** option for multiple file synthesis with Synplify synthesis products. See **-synth** for details.

- **FLW File** - The flow file is an ASCII file that contains the information necessary for XFLOW to run an implementation or simulation flow. When you specify a flow type (described in [XFLOW Flow Types](#)), XFLOW calls a particular flow file. The flow file contains a program block for each program invoked in the flow. It also specifies the directories in which to copy the output files. You can use the default set of flow files as is, or you can modify them. See [Flow Files](#) for more information.
- **OPT Files** - Option files are ASCII files that contain options for each program included in a flow file. You can create your own option files or use the ones provided by Xilinx. See [XFLOW Option Files](#) for more information.
- **Trigger Files** - Trigger files are any additional files that a command line program reads as input, for example, UCF, NCF, PCF, and MFP files. Instead of specifying these files on the command line, these files must be listed in the Triggers line of the flow file. See [XFLOW Flow Types](#) for more information.

XFLOW Output Files

XFLOW always outputs the following files and writes them to your working directory.

- **HIS file** - The `xflow.his` file is an ASCII file that contains the XFLOW command you entered to execute the flow, the flow and option files used, the command line commands of programs that were run, and a list of input files for each program in the flow.
- **LOG file** - The `xflow.log` file is an ASCII file that contains all the messages generated during the execution of XFLOW.
- **SCR, BAT, or TCL file** - This script file contains the command line commands of all the programs run in a flow. This file is created for your convenience, in case you want to review all the commands run, or if you want to execute the script file at a later time. The file extension varies depending on your platform. The default outputs are SCR for Linux and BAT for PC, although you can specify which script file to output by using the `$scripts_to_generate` variable.

In addition, XFLOW outputs one or more of the files shown in the following tables. The output files generated depend on the programs included in the flow files and the commands included in the option files.

Note Report files are written to the working directory by default. You can specify a different directory by using the XFLOW `-rd` option, described in [-rd \(Copy Report Files\)](#), or by using the Report Directory option in the flow file, described in [Flow Files](#). All report files are in ASCII format.

The following table lists files that can be generated for both FPGA and CPLD designs.

XFLOW Output Files (FPGAs and CPLDs)

File Name	Description	To Generate this File...
<code>design_name.bld</code>	This report file contains information about the NGDBuild run, in which the input netlist is translated to an NGD file.	Flow file must include ngdbuild (Use the -implement or -fit flow type)
<code>time_sim.sdf</code> <code>func_sim.sdf</code>	This Standard Delay Format file contains the timing data for a design.	Flow file must include netgen (Use the -tsim or -fsim flow type) Input must be an NGA file, which includes timing information
<code>time_sim.tv</code> <code>func_sim.tv</code>	This is an optional Verilog test fixture file.	Flow file must include netgen (Use the -tsim or -fsim flow type)
<code>time_sim.tvhd</code> <code>func_sim.tvhd</code>	This is an optional VHDL testbench file.	Flow file must include netgen (Use the -tsim or -fsim flow type)
<code>time_sim.v</code> <code>func_sim.v</code>	This Verilog netlist is a simulation netlist expressed in terms of Xilinx simulation primitives. It differs from the Verilog input netlist and should only be used for simulation, not implementation.	Flow file must include netgen (Use the -tsim or -fsim flow type)

File Name	Description	To Generate this File...
<i>time_sim.vhd</i> <i>func_sim.vhd</i>	This VHDL netlist is a simulation netlist expressed in terms of Xilinx simulation primitives. It differs from the VHDL input netlist and should only be used for simulation, not implementation.	Flow file must include netgen (Use the -tsim or -fsim flow type)

The following table lists the output files that can be generated for FPGAs.

XFLOW Output Files (FPGAs)

File Name	Description	To Generate this File...
<i>design_name.bgn</i>	This report file contains information about the BitGen run, in which a bitstream is generated for Xilinx device configuration.	Flow file must include bitgen (Use the -config flow type)
<i>design_name.bit</i>	This bitstream file contains configuration data that can be downloaded to an FPGA using PROMGen, or iMPACT.	Flow file must include bitgen (Use the -config flow type)
<i>design_name.dly</i>	This report file lists delay information for each net in a design.	Flow file must include par (Use the -implement flow type)
<i>design_name.ll</i>	This optional ASCII file describes the position of latches, flip-flops, and IOB inputs and outputs in the BIT file.	Flow file must include bitgen (Use the -config flow type) Option file must include the bitgen -l option
<i>design_name.mrp</i>	This report file contains information about the MAP run, in which a logical design is mapped to a Xilinx FPGA.	Flow file must include map (Use the -implement flow type)
<i>design_name.ncd</i> (by PAR phase) <i>design_name_map.ncd</i> (by MAP phase)	This Native Circuit Description (NCD) file can be used as a guide file. It is a physical description of the design in terms of the components in the target Xilinx device. This file can be a mapped NCD file or a placed and routed NCD file.	Flow file must include map or par (Use the -implement flow type)
<i>design_name.par</i>	This report file contains summary information of all placement and routing iterations.	Flow file must include par (Use the -implement flow type)
<i>design_name.pad</i>	This report file lists all I/O components used in the design and their associated primary pins.	Flow file must include par (Use the -implement flow type)

File Name	Description	To Generate this File...
<i>design_name</i> .rbt	This optional ASCII rawbits file contains ones and zeros representing the data in the bitstream file.	Flow file must include bitgen (Use the -config flow type) Option file must include bitgen -b option
<i>design_name</i> .twr	This report file contains timing data calculated from the NCD file.	Flow file must include trce (Use the -implement flow type)
<i>design_name</i> .xpi	This report file contains information on whether the design routed and timing specifications were met.	Flow file must include par (Use the -implement flow type)

The following table lists the output files that can be generated for CPLDs.

XFLOW Output Files (CPLDs)

File Name	Description	To Generate this File...
<i>design_name</i> .gyd	This ASCII file is a CPLD guide file.	Flow file must include cpldfit (Use the -fit flow type)
<i>design_name</i> .jed	This ASCII file contains configuration data that can be downloaded to a CPLD using iMPACT.	Flow file must include hprep6 (Use the -fit flow type)
<i>design_name</i> .rpt	This report file contains information about the CPLDFit run, in which a logical design is fit to a CPLD.	Flow file must include cpldfit (Use the -fit flow type)
<i>design_name</i> .tim	This report file contains timing data.	Flow file must include taengine (Use the -fit flow type)

XFLOW Syntax

Following is the command line syntax for XFLOW:

```
xflow [-p partname] [flow type] [option file [.opt]] [xflow options] design_name
```

flow type can be any of the flow types listed in [XFLOW Flow Types](#). Specifying a flow type prompts XFLOW to read a certain flow file. You can combine multiple flow types on one command line, but each flow type must have its own option file.

option file can be any of the option files that are valid for the specified flow type. See [XFLOW Option Files](#) for more information. In addition, option files are described in the applicable flow type section.

xflow options can be any of the options described in [XFLOW Options](#). Enter options in any order, preceded them with a dash (minus sign on the keyboard) and separate them with spaces.

design_name is the name of the top-level design file you want to process. See [XFLOW Input Files](#) in the Overview section for a description of input design file formats.

Note If you specify a design name only and do not specify a flow type or option file, XFLOW defaults to the **-implement** flow type and `fast_runtime.opt` option file for FPGAs and the **-fit** flow type and `balanced.opt` option file for CPLDs.

You do not need to specify the complete path for option files. By default, XFLOW uses the option files in your working directory. If the option files are not in your working directory, XFLOW searches for them in the following locations and copies them to your working directory. If XFLOW cannot find the option files in any of these locations, it issues an error message.

- Directories specified using `XIL_XFLOW_PATH`
- Installed area specified with the XILINX environment variable

Note By default, the directory from which you invoked XFLOW is your working directory. If you want to specify a different directory, use the **-wd** option described in [-wd \(Specify a Working Directory\)](#).

XFLOW Flow Types

A flow is a sequence of programs invoked to synthesize, implement, simulate, and configure a design. For example, to implement an FPGA design the design is run through the `NGDBuild`, `MAP`, and `PAR` programs.

Flow types instruct XFLOW to execute a particular flow as specified in the relative flow file (see [Flow Files](#)). You can enter multiple flow types on the command line to achieve a desired flow. This section describes the flow types you can use.

Note All flow types require that an option file be specified. If you do not specify an option file, XFLOW issues an error.

-config (Create a BIT File for FPGAs)

This flow type creates a bitstream for FPGA device configuration using a routed design. It invokes the `fpga.flw` flow file and runs the BitGen program.

Syntax

```
-config option_file
```

Xilinx® provides the `bitgen.opt` option file for use with this flow type.

To use a netlist file as input, you must use the **-implement** flow type with the **-config** flow type.

Example

The following example shows how to use multiple flow types to implement and configure an FPGA:

```
xflow -p xc5vlx30ff324-2 -implement balanced.opt -config  
bitgen.opt testclk.edf
```

To use this flow type without the **-implement** flow type, you must use a placed and routed NCD file as input.

-ecn (Create a File for Equivalence Checking)

This flow type generates a file that can be used for formal verification of an FPGA design. It invokes the `fpga.flw` flow file and runs `NGDBuild` and `NetGen` to create a `netgen.ecn` file. This file contains a Verilog netlist description of your design for equivalence checking.

Syntax

`-ecn option_file`

Xilinx® provides the following option files for use with this flow type.

Option Files for -ecn Flow Type

Option Files	Description
conformal_verilog.opt	Option file for equivalence checking for conformal
formality_verilog.opt	Option file for equivalence checking for formality

-fit (Fit a CPLD)

This flow type incorporates logic from your design into physical macrocell locations in a CPLD. It invokes the `cpld.flw` flow file and runs NGDBuild and CPLDFit to create a JED file.

Syntax

`-fit option_file`

Xilinx® provides the following option files for use with this flow type. These files allow you to optimize your design based on different parameters.

Option Files for -fit Flow Type

Option Files	Description
balanced.opt	Optimized for a balance between speed and density
speed.opt	Optimized for speed
density.opt	Optimized for density

Example

```
xflow -p xc2c64-4-cp56 -fit balanced.opt -tsim generic_vhdl.opt
main_pcb.edn
```

This example shows how to use a combination of flow types to fit a design and generate a VHDL timing simulation netlist for a CPLD.

-fsim (Create a File for Functional Simulation)

This flow type generates a file that can be used for functional simulation of an FPGA or CPLD design. It invokes the `fsim.flw` flow file and runs NGDBuild and NetGen to create a `func_sim.edn`, `func_sim.v`, or `func_sim.vhdl` file. This file contains a netlist description of your design in terms of Xilinx® simulation primitives. You can use the functional simulation file to perform a back-end simulation with a simulator.

Note This flow type can be used alone or with the `-synth` flow type. It cannot be combined with the `-implement`, `-tsim`, `-fit`, or `-config` flow types.

Syntax

`-fsim option_file`

Xilinx provides the following option files, which are targeted to specific vendors, for use with this flow type.

Option Files for -fsim Flow Type

Option File	Description
<code>generic_vhdl.opt</code>	Generic VHDL
<code>modelsim_vhdl.opt</code>	ModelSim VHDL
<code>generic_verilog.opt</code>	Generic Verilog
<code>modelsim_verilog.opt</code>	ModelSim Verilog
<code>nc_verilog.opt</code>	NC-Verilog
<code>vcs_verilog.opt</code>	VCS Verilog
<code>nc_vhdl.opt</code>	NC-VHDL

Example

The following example shows how to generate a Verilog functional simulation netlist for an FPGA design.

```
xflow -p xc5vlx30ff324-2 -fsim generic_verilog.opt testclk.v
```

-implement (Implement an FPGA)

This flow type implements your design. It invokes the `fpga.flw` flow file and runs NGDBuild, MAP, PAR, and then TRACE. It outputs a placed and routed NCD file.

Syntax

```
-implement option_file
```

Xilinx® provides the following option files for use with this flow type. These files allow you to optimize your design based on different parameters.

Option Files for -implement Flow Type

Option Files	Description
<code>fast_runtime.opt</code>	Optimized for fastest runtimes at the expense of design performance Recommended for medium to slow speed designs
<code>balanced.opt</code>	Optimized for a balance between speed and high effort
<code>high_effort.opt</code>	Optimized for high effort at the expense of longer runtimes Recommended for creating designs that operate at high speeds

Example

The following example shows how to use the `-implement` flow type:

```
xflow -p xc5vlx30ff324-2 -implement balanced.opt testclk.edf
```

-sta (Create a File for Static Timing Analysis)

This flow type generates a file that can be used to perform static timing analysis of an FPGA design. It invokes the `fpga.flw` flow file and runs NGDBuild and NetGen to generate a Verilog netlist compatible with supported static timing analysis tools.

This command is available only for Spartan®-3, Spartan-3A, Spartan-3E devices.

Syntax

`-sta option_file`

Xilinx® provides the `theprimetime_verilog.opt` option file for use with this flow type.

-synth

This flow type allows you to synthesize your design for implementation in an FPGA, for fitting in a CPLD, or for compiling for functional simulation. The input design file can be a Verilog or VHDL file.

You can use the `-synth` flow type alone or combine it with the `-implement`, `-fit`, or `-fsim` flow type. If you use the `-synth` flow type alone, XFLOW invokes either the `fpga.flw` or `cpld.flw` file and runs XST to synthesize your design. If you combine the `-synth` flow type with the `-implement`, `-fit`, or `-fsim` flow type, XFLOW invokes the appropriate flow file, runs XST to synthesize your design, and processes your design as described in one of the following sections:

- [-implement \(Implement an FPGA\)](#)
- [-fit \(Fit a CPLD\)](#)
- [-fsim \(Create a File for Functional Simulation\)](#)

Syntax

`-synth option_file`

Note When using the `-synth` flow type, you must specify the `-p` option.

You can use the `-synth` command to synthesize using either XST or Synplify synthesis products. The synthesis tool invoked depends on the option file that you use.

Xilinx® provides the following option files for use with the `-synth` flow type. These files allow you to optimize your design based on different parameters.

Option File	Description
<code>xst_vhdl.opt</code> <code>synplicity_vhdl.opt</code>	Optimizes a VHDL source file for speed, which reduces the number of logic levels and increases the speed of the design
<code>xst_verilog.opt</code> <code>synplicity_verilog.opt</code>	Optimizes a Verilog source file for speed, which reduces the number of logic levels and increases the speed of the design
<code>xst_mixed.opt</code>	Optimizes a mixed level VHDL and Verilog source file for speed, which reduces the number of logic levels and increases the speed of the design.

Synthesize a File Using XST

```
xflow -p xc5vlx30ff324-2 -synth xst_verilog.opt mydesign.v
```

This example uses XST to synthesize the Verilog design in `mydesign.v`.

Synthesize Multiple Files Using XST

If you have multiple VHDL or Verilog files, you can use a PRJ file that references these files as input.

```
xflow -p xc5v1x30ff324-2 -synth xst_vhdl.opt mydesign.prj
```

This example uses XST to synthesize all of the VHDL files specified in `mydesign.prj`.

Synthesize a File Using Synplify synthesis products

```
xflow -p xc5v1x30ff324-2 -synth synplicity_vhdl.opt mycdesign.vhd
```

This example uses Synplify synthesis products to synthesize the VHDL design in `mycdesign.vhd`.

Synthesize Multiple Files Using Synplify synthesis products

If you have multiple VHDL files, you must list all the source files in a text file, one per line and pass that information to XFLOW using the `-g` option.

```
xflow -p xc5v1x30ff324-2 -g srclist:filelist.txt -synth  
synplicity_vhdl.opt mydesign.vhd
```

This example uses Synplify synthesis products to synthesize the VHDL files listed in `filelist.txt`. `mydesign.vhd` is the top level design file for this project.

Synthesize and Implement using XST

```
xflow -p xc5v1x30ff324-2 -synth xst_vhdl.opt -implement  
balanced.opt testclk.prj
```

The following example shows how to use a combination of flow types to synthesize and implement a design:

-tsim (Create a File for Timing Simulation)

This flow type generates a file that can be used for timing simulation of an FPGA or CPLD design. It invokes the `fpga.flw` or `cpld.flw` flow file, depending on your target device. For FPGAs, it runs NetGen. For CPLDs, it runs TSim and NetGen. This creates a `time_sim.v` or `time_sim.vhdl` file that contains a netlist description of your design in terms of Xilinx® simulation primitives. You can use the output timing simulation file to perform a back-end simulation with a simulator.

Syntax

```
-tsim option_file
```

Xilinx provides the following option files, which are targeted to specific vendors, for use with this flow type.

Option Files for -tsim Flow Type

Option File	Description
generic_vhdl.opt	Generic VHDL
modelsim_vhdl.opt	ModelSim VHDL
generic_verilog.opt	Generic Verilog
modelsim_verilog.opt	ModelSim Verilog
nc_verilog.opt	NC-Verilog
vcs_verilog.opt	VCS Verilog
nc_vhdl.opt	NC-VHDL

Example

The following example shows how to use a combination of flow types to fit and perform a VHDL timing simulation on a CPLD:

```
xflow -p xc2c64-4-cp56 -fit balanced.opt -tsim generic_vhdl.opt
main_pcb.vhd
```

Flow Files

When you specify a flow type on the command line, XFLOW invokes the appropriate flow file and executes some or all of the programs listed in the flow file. These files have a .flw extension. Programs are run in the order specified in the flow file.

Xilinx Flow Files

Xilinx® provides three flow files. You can edit these flow files, to add a new program, modify the default settings, and add your own commands between Xilinx programs. However, you cannot create new flow files of your own.

The following table lists the flow files invoked for each flow type.

Flow Type	Flow File	Devices	Flow Phase	Programs Run
-synth	fpga.flw	FPGA	Synthesis	XST Synplify synthesis products
-implement	fpga.flw	FPGA	Implementation	NGDBuild, MAP, PAR, TRACE
-tsim	fpga.flw	FPGA	Timing Simulation	NGDBuild, NetGen
-ecn	fpga.flw	FPGA	Equivalence Checking	NGDBuild, NetGen
-sta	fpga.flw	FPGA	Static Timing Analysis	NGDBuild, NetGen
-config	fpga.flw	FPGA	Configuration	BitGen
-synth	cpld.flw	CPLD	Synthesis	XST Synplify synthesis products
-fit	cpld.flw	CPLD	Fit	NGDBuild, CPLDFit, TAEngine, Hprep6
-tsim	cpld.flw	CPLD	Timing Simulation	TSim, NetGen

Flow Type	Flow File	Devices	Flow Phase	Programs Run
-synth	fsim.flw	FPGA CPLD	Synthesis	XST Synplify synthesis products
-fsim	fsim.flw	FPGA CPLD	Functional Simulation	NGDBuild, NetGen

Flow File Format

The flow file is an ASCII file that contains the following information:

Note You can use variables for the file names listed on the Input, Triggers, Export, and Report lines. For example, if you specify **Input: <design>.vhd** on the Input line, XFLOW automatically reads the VHDL file in your working directory as the input file.

- **ExportDir** - This section specifies the directory in which to copy the output files of the programs in the flow. The default directory is your working directory.

Note You can also specify the export directory using the **-ed** command line option. The command line option overrides the ExportDir specified in the flow file.
- **ReportDir** - This section specifies the directory in which to copy the report files generated by the programs in the flow. The default directory is your working directory.

Note You can also specify the report directory using the **-rd** command line option. The command line option overrides the ReportDir specified in the flow file.
- **Global user-defined variables** - This section allows you to specify a value for a global variable, as shown in the following example:

```
Variables
$simulation_output = time_sim;
End variables
```

The flow file contains a program block for each program in the flow. Each program block includes the following information:

- **Program** *program_name*
This line identifies the name of the program block. It also identifies the command line executable if you use an executable name as the *program_name*, for example, **ngdbuild**. This is the first line of the program block.
- **Flag:** **ENABLED** | **DISABLED**
 - **ENABLED:** This option instructs XFLOW to run the program if there are options in the options file.
 - **DISABLED:** This option instructs XFLOW to *not* run the program even if there are corresponding options in the options file.
- **Input:** *filename*
This line lists the name of the input file for the program. For example, the NGDBuild program block might list *design.edn*.
- **Triggers:**
This line lists any additional files that should be read by the program. For example, the NGDBuild program block might list *design.ucf*.
- **Exports:**
This line lists the name of the file to export. For example, the NGDBuild program block might list *design.ngd*.
- **Reports:**

This line lists the report files generated. For example, the NGDBuild program block might list `design.bld`.

- **Executable:** *executable_name*

This line is optional. It allows you to create multiple program blocks for the same program. When creating multiple program blocks for the same program, you must enter a name other than the program name in the Program line (for example, enter **post_map_trace**, not **trce**). In the Executable line, you enter the name of the program as you would enter it on the command line (for example, **trce**).

For example, if you want to run TRACE after MAP and again after PAR, the program blocks for post-MAP TRACE and post-PAR TRACE appear as follows:

```
Program post_map_trce
Flag: ENABLED;
Executable: trce;
Input: <design>_map.ncd;
Exports: <design>.twr, <design>.tsi;
End Program post_map_trce

Program post_par_trce
Flag: ENABLED;
Executable: trce;
Input: <design>.ncd;
Reports: <design>.twr, <design>.tsi;
End Program post_par_trce
```

Note If your option file includes a corresponding program block, its Program line must match the Program line in the flow file (for example, `post_map_trace`).

End Program *program_name*

This line identifies the end of a program block. The *program_name* should be consistent with the *program_name* specified on the line that started the program block.

User Command Blocks

To run your own programs in the flow, you can add a user command block to the Flow File. The syntax for a user command block is the following:

```
UserCommand
  Cmdline: <user_cmdline>;
End UserCommand
```

Following is an example:

```
UserCommand
  Cmdline: myscript.csh;
End UserCommand
```

Note You cannot use the asterisk (*) dollar sign (\$) and parentheses () characters as part of your command line command.

XFLOW Option Files

Option files contain the options for all programs run in a flow. These files have a `.opt` extension. Xilinx® provides option files for each flow type, as described in the different sections of [XFLOW Flow Types](#). You can also create your own option files.

Note If you want to create your own option files, it is both easier and safer to make a copy of an existing file, rename it, and then modify it.

XFLOW Option File Format

Option files are in ASCII format. They contain program blocks that correspond to the programs listed in the flow files. Option file program blocks list the options to run for each program. Program options can be command line options or parameter files.

- Command Line Options

For information on the different command line options for each program, see the program-specific chapters of this guide, or from the command line type the program name followed by `-h` on the command line. Some options require that you specify a particular file or value.

- Parameter files

Parameter files specify parameters for a program. Parameters are written into the specified file. For example, Xilinx Synthesis Technology (XST) uses a script file to execute its command line options:

```
Program xst
  -ifn <design>_xst.scr;
  -ofn <design>_xst.log;
  ParamFile: <design>_xst.scr
    "run";
    "-ifn <synthdesign>";
    "-ofn <design>.ngc";
  .
  .
  .
  End ParamFile
End Program xst
```

Note You can use variables for the file names listed in the option files. For example, if you specify `design_name.vhd` as an input file, XFLOW automatically reads the VHDL file in your working directory as the input file.

XFLOW Options

This section describes the XFLOW command line options. These options can be used with any of the flow types described in the preceding section.

- `-config` (Create a BIT File for FPGAs)
- `-ecn` (Create a File for Equivalence Checking)
- `-ed` (Copy Files to Export Directory)
- `-f` (Execute Commands File)
- `-fit` (Fit a CPLD)
- `-fsim` (Create a File for Functional Simulation)
- `-g` (Specify a Global Variable)
- `-implement` (Implement an FPGA)
- `-log` (Specify Log File)
- `-norun` (Creates a Script File Only)
- `-o` (Change Output File Name)
- `-p` (Part Number)
- `-rd` (Copy Report Files)
- `-sta` (Create a File for Static Timing Analysis)
- `-synth`
- `-tsim` (Create a File for Timing Simulation)
- `-wd` (Specify a Working Directory)

-ed (Copy Files to Export Directory)

This option copies files listed in the Export line of the flow file to the directory you specify. If you do not use the `-ed` option, the files are copied to the working directory. See [Flow Files](#) for a description of the Export line of the flow file.

Syntax

```
-ed export_directory
```

If you use the `-ed` option with the `-wd` option and do not specify an absolute path name for the export directory, the export directory is placed underneath the working directory.

Examples

In the following example, the `export3` directory is created underneath the `sub3` directory:

```
xflow -implement balanced.opt -wd sub3 -ed export3 testclk.vhd
```

If you do not want the export directory to be a subdirectory of the working directory, enter an absolute path name as in the following example:

```
xflow -implement balanced.opt -wd sub3 -ed /usr/export3  
testclk.vhd
```

-f (Execute Commands File)

This option executes the command line arguments in the specified *command_file*.

Syntax

```
-f command_file
```

For more information on the `-f` option, see [-f \(Execute Commands File\)](#) in the Introduction chapter.

-g (Specify a Global Variable)

This option allows you to assign a value to a variable in a flow or option file. This value is applied globally.

Syntax

```
-g variable:value
```

Example

The following example shows how to specify a global variable at the command line:

```
xflow -implement balanced -g $simulation_output:time_sim calc
```

Note If a global variable is specified both on the command line and in a flow file, the command line takes precedence over the flow file.

-log (Specify Log File)

This option allows you to specify a log filename at the command line. XFLOW writes the log file to the working directory after each run. By default, the log filename is `xflow.log`.

Syntax

```
-log
```

-norun (Creates a Script File Only)

By default, XFLOW runs the programs enabled in the flow file. Use this option if you do not want to run the programs but instead want to create a script file (SCR, BAT, or TCL). XFLOW copies the appropriate flow and option files to your working directory and creates a script file based on these files. This is useful if you want to check the programs and options listed in the script file before executing them.

Syntax

```
-norun
```

Example

Following is an example:

```
xflow -implement balanced.opt -norun testclk.edf
```

In this example, XFLOW copies the `balanced.opt` and `fpga.flw` files to the current directory and creates the following script file:

```
#####
# Script file to run the flow
#
#####
# Command line for ngdbuild
#
ngdbuild -p xc5vlx30ff324-2 -nt timestamp /home/
xflow_test/testclk.edf testclk.ngd
#
# Command line for map
#
map -o testclk_map.ncd testclk.ngd testclk.pcf
#
# Command line for par
#
par -w -ol high testclk_map.ncd testclk.ncd
testclk.pcf
#
# Command line for post_par_trce
#
trce -e 3 -o testclk.twr testclk.ncd testclk.pcf
```

-o (Change Output File Name)

This option allows you to change the output file base name. If you do not specify this option, the output file name has the base name as the input file in most cases.

Syntax

```
-o output_filename
```

Example

The following example shows how to use the `-o` option to change the base name of output files from `testclk` to `newname`:

```
xflow -implement balanced.opt -o newname testclk.edf
```

-p (Part Number)

This option specifies the part into which your design is implemented.

Syntax

```
-p part_number
```

Note For syntax details and examples, see [-p \(Part Number\)](#) in the Introduction chapter.

By default (without the `-p` option), XFLOW searches for the part name in the input design file. If XFLOW finds a part number, it uses that number as the target device for the design. If XFLOW does not find a part number in the design input file, it prints an error message indicating that a part number is missing.

For FPGA part types, you must designate a part name with a package name. If you do not, XFLOW halts at MAP and reports that a package needs to be specified. You can use the `partgen -i` option to obtain package names for installed devices. See [-i \(Output List of Devices, Packages, and Speeds\)](#) in the PARTGen chapter for information.

For CPLD part types, either the part number or the family name can be specified.

Example

The following example show how to use the `-p` option for a Virtex®-5 design:

```
xflow -p xc5v1x30ff324-2 -implement high_effort.opt testclk.edf
```

-rd (Copy Report Files)

This option copies the report files output during the XFLOW run from the working directory to the specified directory. The original report files are kept intact in the working directory.

Syntax

```
-rd report_directory
```

You can create the report directory prior to using this option, or specify the name of the report directory and let XFLOW create it for you. If you do not specify an absolute path name for the report directory, XFLOW creates the specified report directory in your working directory.

Examples

Following is an example in which the report directory (reportdir) is created in the working directory (workdir):

```
xflow -implement balanced.opt -wd workdir -rd reportdir  
testclk.edf
```

If you do not want the report directory to be a subdirectory of the working directory, enter an absolute path name, as shown in the following example:

```
xflow -implement balanced.opt -wd workdir -rd /usr/reportdir  
testclk.edf
```

-wd (Specify a Working Directory)

The default behavior of XFLOW (without the `-wd` option) is to use the directory from which you invoked XFLOW as the working directory. The `-wd` option allows you to specify a different directory as the working directory. XFLOW searches for all flow files, option files, and input files in the working directory. It also runs all subprograms and outputs files in this directory.

Syntax

```
-wd working_directory
```

Note If you use the `-wd` option and want to use a UCF file as one of your input files, you must copy the UCF file into the working directory.

Unless you specify a directory path, the working directory is created in the current directory.

Examples

For example, if you enter the following command, the directory sub1 is created in the current directory:

```
xflow -fsim generic_verilog.opt -wd sub1 testclk.v
```

You can also enter an absolute path for a working directory as in the following example. You can specify an existing directory or specify a path for XFLOW to create.

```
xflow -fsim generic_verilog.opt -wd /usr/project1 testclk.v
```

Running XFLOW

The following sections describe common ways to use XFLOW.

Using XFLOW Flow Types in Combination

You can combine flow types on the XFLOW command line to run different flows.

The following example shows how to use a combination of flow types to implement a design, create a bitstream for FPGA device configuration, and generate an EDIF timing simulation netlist for an FPGA design named testclk:

```
xflow -p xc5vlx30ff324-2 -implement balanced -tsim  
generic_verilog -config bitgen testclk
```

The following example shows how to use a combination of flow types to fit a CPLD design and generate a VHDL timing simulation netlist for a CPLD design named main_pcb:

```
xflow -p xc5vlx30ff324-2 -fit balanced -tsim generic_vhdl  
main_pcb
```

Running Smart Flow

Smart Flow automatically detects changes to your input files and runs the flow from the appropriate point. XFLOW detects changes made to design files, flow files, option files, and trigger files. It also detects and reruns aborted flows. To run Smart Flow, type the XFLOW syntax without specifying an extension for your input design. XFLOW automatically detects which input file to read and starts the flow at the appropriate point.

For example, if you enter the following command and XFLOW detects changes to the calc.edf file, XFLOW runs all of the programs in the flow and option files.

```
xflow -implement balanced.opt calc
```

Using the SCR, BAT, or TCL File

Every time you run XFLOW, it creates a script file that includes the command line commands of all the programs run. You can use this file for the following:

- Review this file to check which commands were run
- Execute this file instead of running XFLOW

By default, this file is named `xflow_script.bat` (PC) or `xflow_script.scr` (Linux), although you can specify the output script file type by using the `$scripts_to_generate` option. To execute the script file, type `xflow_script.bat`, `xflow_script.scr`, or `xflow_script.tcl` at the command line.

If you choose to execute the script file instead of using XFLOW, the features of Smart XFLOW are not enabled. For example, XFLOW starts the flow at an appropriate point based on which files have changed, while the script file simply runs every command listed in the file. In addition, the script file does not provide error detection. For example, if an error is encountered during NGDDBuild, XFLOW detects the error and terminates the flow, while the script file continues and runs MAP.

Using the XIL_XFLOW_PATH Environment Variable

This environment variable is useful for team-based design. By default, XFLOW looks for all flow and option files in your working directory. However, this variable allows you to store flow and option files in a central location and copy them to your team members local directories, ensuring consistency.

To use this variable, do the following:

1. Modify the flow and option files as necessary.
2. Copy the flow and option files to the central directory, and provide your team members with the directory location.
3. Instruct your team members to type the following from their working directory:

```
set XIL_XFLOW_PATH=name_of_central_directory
```

When a team member runs XFLOW, it copies all flow and option files from the central directory to his or her local directory.

If you alter the files in the central directory and want to repopulate the users local directories, they must delete their local copies of the flow and option files, set the XIL_XFLOW_PATH environment variable, and rerun XFLOW to copy in the updated files.

NGCBuild

This chapter describes the NGCBuild utility.

NGCBuild Overview

The NGCBuild utility:

- Compiles multiple source netlists (EDIF and NGC files) into a single NGC file that can be delivered as an atomic entity (also known as “incremental linkage”).
- Annotates a User Constraints File (UCF) onto an existing netlist or collection of netlists.

Most NGCBuild features are a subset of NGDBuild features. NGCBuild:

1. Opens the top level EDIF or NGC netlist.
2. Recursively traverses (top-down) the design hierarchy of the top level netlist, checking for references to other netlists that are present in the same directory, or in directories specified by the `-sd` command line option.
3. Annotates a UCF file to the resulting, linked design hierarchy (optional).
4. Writes the resulting design hierarchy to a new NGC file, as specified on the command line.

NGCBuild Device Support

This program is compatible with the following device families:

- 7 series
- Spartan®-3, Spartan-3A, Spartan-3E, and Spartan-6
- Virtex®-4, Virtex-5, and Virtex-6
- CoolRunner™ XPLA3 and CoolRunner-II
- XC9500 and XC9500XL

Using NGCBuild in Flows

You can use NGCBuild as a standalone utility, or in a number of different flows:

- Use NGCBuild to:
 - Consolidate several design sources into one so that the IP (partial design) can be distributed in one file, or
 - Add new constraints to an existing piece of IP.
- When running NGC simulation, use NGCBuild to consolidate the different pieces of the design (EDIF and NGC files) into a single unit. The whole design can then be simulated using the UNISIM library.

Other flows also use NGCBuild, but the two examples above illustrate the main NGCBuild use cases.

NGCBuild Input File (<infile[.ext]>)

The input file is named <infile[.ext]>. This is the root name of a top level EDIF, NGC, or NGO input file. The input file can have an explicit extension such as:

- .edn
- .edf
- .ngc

If no extension is given, NGCBuild searches for an applicable input file, running EDIF2NGD if necessary.

NGCBuild Output File <outfile[.ngc]>

The output file is named <outfile[.ngc]>. The .ngc extension is optional.

The output file must be specified.

In order to avoid overwriting the input file (where the input file is also an .ngc), <infile[.ext]> and <outfile[.ngc]> must refer to different files. The file names can be the same only if the paths differ.

Validating the NGC File in NGCBuild

NGCBuild does not perform a design rules check (DRC), since few or no significant checks can be made in the absence of library expansion. Successfully running NGCBuild does not mean that the generated NGC file will pass NGDBuild successfully. To validate the resulting NGC file, you must process it (either alone or in a test bench) through the standard flow, starting with NGDBuild.

NGCBuild Messages and Reports

NGCBuild creates a BLC file similar to the BLD file created by NGDBuild. The BLC file:

- Reports on each netlist that was compiled or read into the design hierarchy.
- Contains a design results summary section similar to NGDBuild.
- Contains few or no warnings or errors since no DRC was performed.

NGCBuild Syntax

To start NGCBuild, run the following command:

```
ngcbuild [options] infile[.ext]outfile[.ngc]
```

This command:

1. Opens NGCBuild.
2. Reads the design.
3. Converts the design to an NGC file.

NGCBuild Options

NGCBuild options are a subset of the NGDBuild options, and have the same functionality. NGCBuild supports the following options:

- `-aul` (Allow Unmatched LOCs)
- `-dd` (Destination Directory)
- `-f` (Execute Commands File)
- `-i` (Ignore UCF File)
- `-insert_keep_hierarchy` (Insert KEEP_HIERARCHY constraint)
- `-intstyle` (Integration Style)
- `-filter` (Filter File)
- `-nt` (Netlist Translation Type)
- `-p` (Part Number)
- `-quiet` (Quiet)
- `-r` (Ignore LOC Constraints)
- `-sd` (Search Specified Directory)
- `-uc` (User Constraints File)
- `-ur` (Read User Rules File)
- `-verbose` (Report All Messages)

-aul (Allow Unmatched LOCs)

By default the program generates an error if the constraints specified for pin, net, or instance names in the UCF or NCF file cannot be found in the design, and an NGD file is not written. Use this option to generate a warning instead of an error for LOC constraints and make sure an NGD file is written.

Syntax

`-aul`

You may want to run this program with the `-aul` option if your constraints file includes location constraints for pin, net, or instance names that have not yet been defined in the HDL or schematic. This allows you to maintain one version of your constraints files for both partially complete and final designs.

Note When using this option, make sure you do not have misspelled net or instance names in your design. Misspelled names may cause inaccurate placing and routing.

-dd (Destination Directory)

This option specifies the directory for intermediate files (design NGO files and netlist files). If the `-dd` option is not specified, files are placed in the current directory.

Syntax

`-dd` *NGOoutput_directory*

-f (Execute Commands File)

This option executes the command line arguments in the specified *command_file*.

Syntax

`-f` *command_file*

For more information on the `-f` option, see [-f \(Execute Commands File\)](#) in the Introduction chapter.

-i (Ignore UCF File)

This option tells NGCBuild to ignore the UCF file. Without this option NGCBuild reads the constraints in the UCF file automatically if the UCF file in the top-level design netlist directory has the same base name as the input design file and a `.ucf` extension.

Syntax

`-i`

Note If you use this option, do not use the `-uc` option.

-insert_keep_hierarchy (Insert KEEP_HIERARCHY constraint)

This option automatically attaches the `KEEP_HIERARCHY` constraint to each input netlist. It should only be used when performing a bottom-up synthesis flow, where separate netlists are created for each piece of hierarchy. When using this option you should use good design practices as described in the [Synthesis and Simulation Design Guide \(UG626\)](#).

Syntax

`-insert_keep_hierarchy`

Note Care should be taken when trying to use this option with Cores, as they may not be coded for maintaining hierarchy.

-intstyle (Integration Style)

This option limits screen output, based on the integration style that you are running, to warning and error messages only.

Syntax

`-intstyle` *ise|xflow|silent*

When using `-intstyle`, one of three modes must be specified:

- `-intstyle ise` indicates the program is being run as part of an integrated design environment.
- `-intstyle xflow` indicates the program is being run as part of an integrated batch flow.
- `-intstyle silent` limits screen output to warning and error messages only.

Note `-intstyle` is automatically invoked when running in an integrated environment such as Project Navigator or XFLOW.

-filter (Filter File)

This option specifies a filter file, which contains settings to capture and filter messages produced by the program during execution.

Syntax

`-filter [filter_file]`

By default, the filter file name is `filter.filter`.

-nt (Netlist Translation Type)

This option determines how timestamps are treated by the Netlist Launcher when it is invoked by NGCBuild. A timestamp is information in a file that indicates the date and time the file was created.

Syntax

`-nt timestamp|on|off`

`timestamp` (the default) instructs the Netlist Launcher to perform the normal timestamp check and update NGO files according to their timestamps.

`on` translates netlists regardless of timestamps (rebuilding all NGO files).

`off` does not rebuild an existing NGO file, regardless of its timestamp.

-p (Part Number)

This option specifies the part into which your design is implemented.

Syntax

`-p part_number`

Note For syntax details and examples, see [-p \(Part Number\)](#) in the Introduction chapter.

-quiet (Quiet)

This option tells the program to only report error and warning messages.

Syntax

`-quiet`

-r (Ignore LOC Constraints)

This option eliminates all location constraints (LOC=) found in the input netlist or UCF file. Use this option when you migrate to a different device or architecture, because locations in one architecture may not match locations in another.

Syntax

`-r`

-sd (Search Specified Directory)

This option adds the specified `search_path` to the list of directories to search when resolving file references (that is, files specified in the schematic with a `FILE=filename` property) and when searching for netlist, NGO, NGC, NMC, and MEM files. You do not have to specify a search path for the top-level design netlist directory, because it is automatically searched by NGCBuild.

Syntax

```
-sd {search_path}
```

The *search_path* must be separated from the `-sd` option by spaces or tabs (for example, `-sd designs` is correct, `-sddesigns` is not). You can specify multiple search paths on the command line. Each must be preceded with the `-sd` option; you cannot specify more than one *search_path* with a single `-sd` option. For example, the following syntax is acceptable for specifying two search paths:

```
-sd /home/macros/counter -sd /home/designs/pal2
```

The following syntax is *not* acceptable:

```
-sd /home/macros/counter /home/designs/pal2
```

-uc (User Constraints File)

This option specifies a User Constraints File (UCF) for the Netlist Launcher to read. The UCF file contains timing and layout constraints that affect the way the logical design is implemented in the target device.

Syntax

```
-uc ucf_file [.ucf]
```

The User Constraints File (UCF) must have a `.ucf` extension. If you specify a UCF without an extension, NGCBuild appends the `.ucf` extension to the file name. If you specify a file name with an extension other than `.ucf`, you get an error message and NGCBuild does not run.

If you do not enter a `-uc` option and a UCF file exists with the same base name as the input design file and a `.ucf` extension, NGCBuild automatically reads the constraints in this UCF file.

See the [Constraints Guide \(UG625\)](#) for more information on the UCF file.

Note NGCBuild only allows one UCF file as input. Therefore, you cannot specify multiple `-uc` options on the command line.

Note If you use this option, do not use the `-i` option.

-ur (Read User Rules File)

This option specifies a user rules file for the Netlist Launcher to access. This file determines the acceptable netlist input files, the netlist readers that read these files, and the default netlist reader options. This file also allows you to specify third-party tool commands for processing designs.

Syntax

```
-ur rules_file [.urf]
```

The user rules file must have a `.urf` extension. If you specify a user rules file with no extension, NGCBuild appends the `.urf` extension to the file name. If you specify a file name with an extension other than `.urf`, you get an error message and NGCBuild does not run.

See [User Rules File \(URF\)](#) in Appendix B for more information.

-verbose (Report All Messages)

This option enhances screen output to include all messages output by the tools run: NGCBuild, the netlist launcher, and the netlist reader. This option is useful if you want to review details about the tools run.

Syntax

`-verbose`

Compplib

This chapter describes the Compplib, which is a program used to compile Xilinx® simulation libraries.

Compplib Overview

Compplib is a tool for compiling the Xilinx® HDL-based simulation libraries with the tools provided by simulator vendors. Libraries are generally compiled or recompiled anytime a new version of a simulator is installed, a new ISE version is installed, a new service pack is installed.

Before starting the functional simulation of your design, you must compile the Xilinx simulation libraries for the target vendor simulator. For this purpose, Xilinx provides Compplib.

Note Do NOT use Compplib with ISim. This simulator comes with the Xilinx libraries pre-compiled.

Design Flow

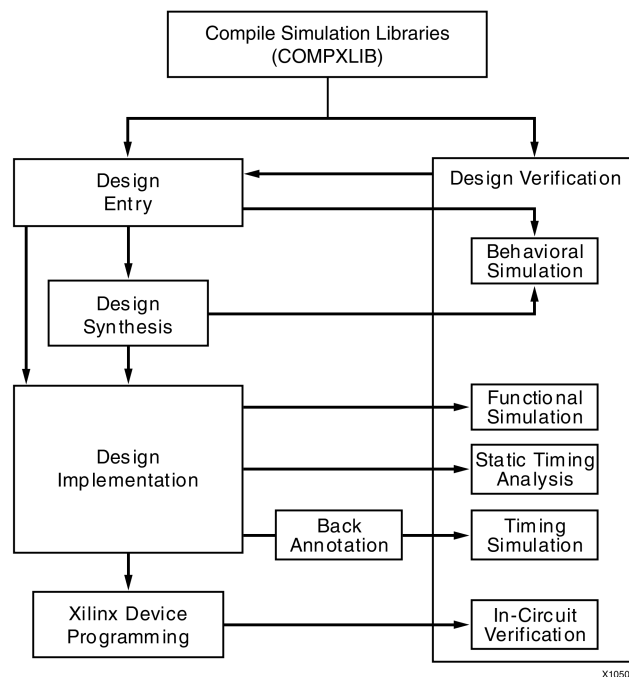

Note Compplib should be rerun when a new simulator, a new ISE® Design Suite version, or a new ISE Design Suite update is installed during a design cycle.

Complib Device Support

This program is compatible with the following device families:

- 7 series
- Spartan®-3, Spartan-3A, Spartan-3E, and Spartan-6
- Virtex®-4, Virtex-5, and Virtex-6
- CoolRunner™ XPLA3 and CoolRunner-II
- XC9500 and XC9500XL

Complib Syntax

To compile simulation libraries from the command line, type:

```
complib [options]
```

options can be any number of the Complib command line options listed in [Complib Options](#). Enter options in any order, preceded them with a dash (minus sign on the keyboard) and separate them with spaces.

For example, the following command compiles all Xilinx® Verilog libraries for the Virtex®-6 device family on the ModelSim SE simulator:

```
complib -s mti_se -arch virtex6 -l verilog
```

For a list of Complib options and syntax details, see [Complib Options](#) in this chapter.

To view Complib help, type **complib -help <value>**

You can specify the value of a specific Complib option or device family to get help information on. See the [Complib Command Line Examples](#) section of this chapter for details.

Note For information on compiling a simulation library in Project Navigator, see the ISE® Help, especially Compiling HDL Simulation Libraries. Various options are available from the Process Properties dialog box in Project Navigator. Project Navigator shows only the options that apply to your specific design flow. For example, for a Virtex-6 project, it shows only the list of libraries required to simulate a Virtex-6 design. To see the compilation results after the libraries are compiled, double-click **View Compilation Log** in Project Navigator to open the `complib.log` file.

Complib Options

This section describes the Complib command line options.

- `-64bit`(perform 64-bit compilation)
- `-arch` (Device Family)
- `-cfg` (Create Configuration File)
- `-dir` (Output Directory)
- `-e` (Existing Directory)
- `-exclude_deprecated` (Exclude Deprecated EDK Libraries)
- `-exclude_sublib` (Exclude EDK Sub-Libraries)
- `-f` (Execute Commands File)
- `-info` (Print Precompiled Library Info)
- `-l` (Language)
- `-lib` (Specify Name of Library to Compile)
- `-log` (Log File)
- `-p` (Simulator Path)
- `-s` (Target Simulator)
- `-source_lib` (Source Libraries)
- `-verbose` (List Detailed Messages)
- `-w` (Overwrite Compiled Library)

-64bit (perform 64-bit compilation)

Use this option to run the Simulator Compilation in 64-bit mode.

Syntax

```
-64bit yes
```

-arch (Device Family)

Use this option to compile selected libraries to the specified device family.

Syntax

```
-arch {device_family | all}
```

If `-arch` is not specified, Complib exits with an error message without compiling the libraries. Specifying “all” rather than a specific device family generates libraries for all device families.

Allowed values for *device_family* are:

- acr2 (for Automotive CoolRunner™-II)
- aspartan3 (for Automotive Spartan®-3)
- aspartan3a (for Automotive Spartan-3A)
- aspartan3adsp (for Automotive Spartan-3A DSP)
- aspartan3e (for Automotive Spartan-3E)
- aspartan6 (for Automotive Spartan-6)
- kintex7 (for Kintex™-7)
- kintex7l (for Kintex-7 Lower Power)
- qvirtex4 (for QPro™ Virtex®-4 Rad Tolerant)
- qvirtex4 (for QPro Virtex-4 Hi-Rel)
- qvirtex5 (for QPro Virtex-5 Hi-Rel)
- qspartan6 (for QPro Spartan-6 Hi-Rel)
- qvirtex6 (for QPro Virtex-6 Hi-Rel)
- spartan3 (for Spartan-3)
- spartan3a (for Spartan-3A)
- spartan3adsp (for Spartan-3A DSP)
- spartan3e (for Spartan-3E)
- spartan6 (for Spartan-6)
- virtex4 (for Virtex-4)
- virtex5 (for Virtex-5)
- virtex6 (for Virtex-6)
- virtex6l (for Virtex-6 Lower Power)
- virtex7 (for Virtex-7)
- virtex7l (for Virtex-7 Lower Power)
- xa9500xl (for Automotive XC9500XL)
- xbr (for CoolRunner-II)
- xc9500 (for XC9500)
- xc9500xl (for XC9500XL)
- xpla3 (for CoolRunner XPLA3)

-cfg (Create Configuration File)

Use this option to create a configuration file with default settings. By default, Complib creates the `complib.cfg` file or optional `<cfg_file>` if it is not present in the current directory.

Use the configuration file to pass runtime options to Complib while compiling the libraries. For more information on the configuration file, see [Specifying Run Time Options](#) in this chapter.

Syntax

```
-cfg [cfg_file]
```

-dir (Output Directory)

Use this option to specify the directory path where you want to compile the libraries. By default, Compplib compiles the libraries as shown in the following table.

Default Compplib Output Directories

Operating System	Default Output Directory
Linux	<code>\$XILINX/language/target_simulator/version/{lin lin64}</code>
Windows	<code>%XILINX%\language\target_simulator\version\{nt nt64}</code>

Syntax

`-dir dir_path`

-e (Existing Directory)

Specifies the directory that contains libraries previously compiled by Compplib.

Syntax

`-e existing_directory`

existing_directory is the directory containing the libraries previously compiled by Compplib.

-exclude_deprecated (Exclude Deprecated EDK Libraries)

Tells Compplib to exclude the deprecated EDK libraries from compilation (for EDK libraries only). Please see the *Embedded System Tools Reference Guide (UG111)* for more information on deprecated libraries.

Syntax

`-exclude_deprecated`

-exclude_sublib (Exclude EDK Sub-Libraries)

Tells Compplib to exclude the sub-libraries defined in the EDK `.pao` file from compilation (for EDK libraries only). Please see the *Embedded System Tools Reference Guide (UG111)* for more information on which libraries are sub-libraries.

Syntax

`-exclude_sublib`

-f (Execute Commands File)

This option executes the command line arguments in the specified *command_file*.

Syntax

`-f command_file`

For more information on the `-f` option, see [-f \(Execute Commands File\)](#) in the Introduction chapter.

-info (Print Precompiled Library Info)

Use this option to print the precompiled information of the libraries. Specify a directory path with **-info** to print the information for that directory.

Syntax

```
-info dir_path
```

-l (Language)

Use this option to specify the language from which the libraries will be compiled.

Syntax

```
-l {all|verilog|vhdl}
```

By default, Compxlib detects the language type from the **-s** (Target Simulator) option. If the simulator supports both Verilog and VHDL, Compxlib:

- Sets the **-l** option to all.
- Compiles both Verilog and VHDL libraries.

If the simulator does not support both Verilog and VHDL, Compxlib:

- Detects the language type supported by the simulator
- Sets the **-l** value accordingly

If you specify **-l**, Compxlib compiles only the libraries for the language that you specify.

Note When the XILINX_EDK environment variable is set and EDK compilation is selected, Compxlib ignores this option and compiles both VHDL and Verilog libraries.

-lib (Specify Name of Library to Compile)

Use this option to specify the name of the library to compile. If the **-lib** option is not specified, or if you specify "all", all of the libraries are compiled.

Syntax

```
-lib [library|all]
```

Valid values for *library* are:

- **unisim** (alias **u**)
- **simprim** (alias **s**)
- **uni9000** (alias **n**)
- **xilinxcorelib** (alias **c**)
- **coolrunner** (alias **r**)
- **edk** (alias **e**)

For multiple libraries, separate **-lib** options with spaces. For example:

```
.. -lib unisim -lib simprim ..
```

Note If you select EDK libraries (**-lib edk**), all ISE® libraries will be compiled because EDK libraries are dependent on UNISIM and SIMPRIM.

-log (Log File)

Specifies the log file for this command.

Syntax

`-log log_file`

log_file is the name of the log file.

-p (Simulator Path)

Use this option to specify the directory path where the simulator executables reside. By default, Complib automatically searches for the path from the \$PATH or %PATH% environment variable. This option is required if the target simulator is not specified in the \$PATH or %PATH% environment variable or to override the path from the \$PATH or %Path% environment variable.

Syntax

`-p dir_path`

-s (Target Simulator)

Use this option to specify the simulator for which the libraries will be compiled.

If you do not specify `-s`, Complib exits without compiling the libraries.

Syntax

`-s simulator`

Valid *simulator* values are:

- `mti_se`
- `mti_pe`
- `mti_de`
- `questa`
- `vcs_mx` (Linux only)
- `ncsim` (Linux only)
- `riviera`
- `active_hdl` (Windows only)

-source_lib (Source Libraries)

Tells Complib to search the specified directory for library source files before searching the default paths found in environment variable XILINX (for ISE® Design Suite) or XILINX_EDK (for EDK).

Note You should not use this option unless explicitly instructed by Xilinx® Technical Support

Syntax

`-source_lib dir_path`

dir_path is the name of the directory in which to start searching for library source files.

-verbose (List Detailed Messages)

Use this option for Complib to list detailed program execution messages in the log file.

Syntax

`-verbose`

-w (Overwrite Compiled Library)

Use this option to overwrite precompiled libraries. By default, Compplib does not overwrite precompiled libraries.

Syntax

`-w`

Compplib Command Line Examples

This section shows command line examples for Compplib.

Compiling Libraries as a System Administrator

System administrators compiling libraries using Compplib should compile the libraries in a default location that is accessible to all users.

The following example shows how to compile the libraries for ModelSim SE for all devices, libraries, and languages:

```
compplib -s mti_se -arch all
```

In this example, Compplib compiles the libraries needed for simulation using ModelSim SE 6.4b. For the location to which the libraries are compiled, see the following table.

ModelSim SE Libraries Locations

	VHDL	Verilog
Linux	<code>\$XILINX/vhdl/mti_se/6.6d/lin</code>	<code>\$XILINX/verilog/mti_se/6.6d/lin</code>
Windows	<code>%XILINX%\vhdl\mti_se\6.6d\nt</code> or <code>%XILINX%\vhdl\mti_se\6.6d\nt64</code>	<code>%XILINX%\verilog\mti_se\6.6d\nt</code> or <code>%XILINX%\verilog\mti_se\6.6d\nt64</code>

Compiling Libraries as a User

When you run Compplib as a user, you should compile the libraries on a per project basis. If your project targets a single device, compile the libraries for that specific device only.

The following example shows how to compile UNISIM and SIMPRIM libraries for NCSim (VHDL) for a design using a Virtex®-5 device:

```
compplib -s ncsim -arch virtex5 -lib unisim -lib simprim -lang  
vhdl -dir ./
```

In this example, Compplib compiles the libraries to the current working directory.

If the system administrator has compiled all of the libraries to the default location, each individual user can map to these libraries as needed. Each user should map to the libraries on a per project basis to minimize the need for unnecessary library mappings in the project location.

The example below shows how to map to the pre-compiled UNISIM and XilinxCoreLib libraries for ModelSim PE for a design using a Virtex-5 device:

```
compplib -s mti_pe -arch virtex5 -lib unisim -lib xilinxcorelib
```

When mapping to a pre-compiled location, do not specify the `-w` option. If there are no pre-compiled libraries in the default location, Compxlib starts to compile the libraries.

Additional Compxlib Examples

Task	Command
Display the Compxlib help on the screen	<code>compxlib -h</code>
Obtain help for a specific option	<code>compxlib -h <option></code>
Obtain help for all the available architectures	<code>compxlib -h arch</code>
Compile all of the Verilog libraries for a Virtex-5 device (UNISIM, SIMPRIM and XilinxCoreLib) on the ModelSim SE simulator and overwrite the results in <code>\$XILINX/verilog/mti_se</code>	<code>compxlib -s mti_se -arch virtex5 -l verilog -w</code>
Compile the Verilog UNISIM, Uni9000 and SIMPRIM libraries for the ModelSim PE simulator and save the results in the <code>\$MYAREA</code> directory	<code>compxlib -s mti_pe -arch all -lib uni9000 -lib simprim -l verilog -dir \$MYAREA</code>
Compile the Verilog Virtex-5 device XilinxCoreLib library for the Synopsys VCS and VCS MX simulators and save the results in the default directory, <code>\$XILINX/verilog/vcs</code>	<code>compxlib -s vcs_mx -arch virtex5 -lib xilinxcorelib</code>
Compile the Verilog CoolRunner™ device library for the Synopsys VCS and VCS MX simulators and save the results in the current directory	<code>compxlib -s vcs_mx -arch coolrunner -lib -dir ./</code>
Print the precompiled library information for the libraries compiled in <code>%XILINX%\xilinxlibs</code>	<code>compxlib -info %XILINX%\xilinxlibs</code>
Print the precompiled library information for the libraries compiled in the <code>\$XILINX</code> directory for the ModelSim SE simulator	<code>compxlib -info \$XILINX/mti_se/</code>
Create <code>compxlib.cfg</code> with default options	<code>compxlib -cfg</code>

Specifying Runtime Options

Use the `compxlib.cfg` file to specify runtime options for Compxlib. By default, Compxlib creates this file in the current directory. To automatically create this file with its default settings, use the `-cfg` option. See [-cfg \(Create Configuration File\)](#) for more information.

You can specify the following runtime options in the configuration file.

EXECUTE

EXECUTE: on|off

By default, the value is on.

If the value is on, Compxlib compiles the libraries.

If the value is off, Compxlib generates only the list of compilation commands in the `compxlib.log` file, without executing them.

EXTRACT_LIB_FROM_ARCH

EXTRACT_LIB_FROM_ARCH: on|off

This option supports Early Access devices. Do not change this option.

LOCK_PRECOMPILED

LOCK_PRECOMPILED: on|off

By default, the value is off.

If the value is off, Complib compiles the dependent libraries automatically if they are not precompiled.

If the value is on, Complib does not compile the precompiled libraries.

For example, if you want to compile the XilinxCoreLib Library, Complib looks for this value to see if the dependent UNISIM libraries should be compiled.

LOG_CMD_TEMPLATE

LOG_CMD_TEMPLATE: on|off

By default, the value is off.

If the value is off, Complib does not print the compilation command line in the `complib.log` file.

If the value is on, Complib prints the compilation commands in the `complib.log` file.

HIER_OUT_DIR

HIER_OUT_DIR: on|off

By default, the value is off.

If the value is off, Complib places all of the libraries in the directory that is specified with the `-dir` switch.

If the value is on, Complib creates hierarchical output directories for the libraries for each of the simulators.

PRECOMPILED_INFO

PRECOMPILED_INFO: on|off

By default, the value is on.

If the value is on, Complib prints the precompiled library information including the date the library was compiled.

If the value is off, Complib does not print the precompiled library information.

BACKUP_SETUP_FILES

BACKUP_SETUP_FILES: on|off

By default, the value is on.

If the value is on, Complib creates a backup of the all the simulator specific setup files (`modelsim.ini` for MTI, `cds.lib` and `hdl.var` for NCSim, and `synopsys_sim.setup` for Synopsys VCS and VCS MX) that it wrote out in the previous run.

If the value is off, Complib does not create a backup of the setup files.

FAST_COMPILE

FAST_COMPILE: on|off

By default, the value is on.

If the value is on, Complib uses advanced compilation techniques for faster library compilation for select libraries.

If the value is off, Complib does not use the advanced compilation methods and reverts to traditional methods for compilation.

ABORT_ON_ERROR

ABORT_ON_ERROR: on|off

By default, the value is off.

If the value is off, Complib does not error out if a compilation error occurs.

If the value is on, Complib errors out if a compilation error occurs.

ADD_COMPILATION_RESULTS_TO_LOG

ADD_COMPILATION_RESULTS_TO_LOG: on|off

By default, the value is on.

If the value is on, Complib writes to the log file with the name specified by **-log**.

If the value is off, Complib ignores **-log**.

USE_OUTPUT_DIR_ENV

USE_OUTPUT_DIR_ENV: empty|<NAME_OF_ENVIRONMENT_VARIABLE>

By default, the value is empty.

If the value is empty, Complib does not look for an environment variable for the output directory. Instead, it uses the directory specified by **-o**.

If the value is <NAME_OF_ENV_VAR>, Complib looks on the system for an environment variable with the name listed in this option, and compiles the libraries to that folder. See the following example.

cfg file	USE_OUTPUT_DIR_ENV:MY_LIBS
system setting	setenv MY_LIBS /my_compiled_libs
compiles the libraries to the folder	/my_compiled_libs

OPTION

OPTION

Simulator language command line options.

OPTION:Target_Simulator:Language:Command_Line_Options

By default, Complib picks the simulator compilation commands specified in the Command_Line_Options.

You can add or remove the options from `Command_Line_Options` depending on the compilation requirements.

Sample Configuration File (Windows Version)

The following is a sample `compplib.cfg` file generated with default settings:

```

*****
# /build/xfndry/0.40/rtf/bin/lin/unwrapped/compplib configuration file - compplib.cfg
# Fri Jan 7 14:04:06 2011
#
# Important :-
# All options/variables must start from first column
#
*****

#
RELEASE_VERSION:13.1
#
RELEASE_BUILD:0.40
#
# set current simulator name
SIMULATOR_NAME:
#
# set current language name
LANGUAGE_NAME:all
#
# set compilation execution mode
EXECUTE:on
#
# print compilation command template in log file
LOG_CMD_TEMPLATE:off
#
# Hierarchical Output Directories
HIER_OUT_DIR:off
#
# print Pre-Compiled library info
PRECOMPILED_INFO:on
#
# create backup copy of setup files
BACKUP_SETUP_FILES:on
#
# use enhanced compilation techniques for faster library compilation
# (applicable to selected libraries only)
FAST_COMPILE:on
#
# save compilation results to log file with the name specified with -log option
ADD_COMPILATION_RESULTS_TO_LOG:on
#
# abort compilation process if errors are detected in the library
ABORT_ON_ERROR:off
#
# compile library in the directory specified by the environment variable if the
# -dir option is not specified
OUTPUT_DIR_ENV:
#
#////////////////////////////////////
# Setup file name: ModelSim SE
SET:mti_se:MODELSIM=modelsim.ini
#
# ModelSim SE options for VHDL Libraries
# Syntax:-
# OPTION:<simulator_name>:<language>:<library>:<options>
# <library> :- u (unisim) s (simprim) c (xilinxcorelib)
#           r (coolrunner) i (secureip) e (edk)
# vcom -work <library> <OPTION> <file_name>
#
OPTION:mti_se:vhdl:u:-source -93 -novopt -explicit
OPTION:mti_se:vhdl:s:-source -93 -novopt -explicit
OPTION:mti_se:vhdl:c:-source -93 -novopt -explicit
OPTION:mti_se:vhdl:r:-source -93 -novopt -explicit

```

```

OPTION:mti_se:vhdl:i:-source -93 -novopt -explicit
OPTION:mti_se:vhdl:e:-93 -novopt -quiet -explicit
#
# ModelSim SE options for VERILOG Libraries
# Syntax:-
# OPTION:<simulator_name>:<language>:<library>:<options>
# <library> :- u (unisim) s (simprim) c (xilinxcorelib)
#             r (coolrunner) i (secureip) e (edk)
# vlog -work <library> <OPTION> <file_name>
#
OPTION:mti_se:verilog:u:-source -novopt
OPTION:mti_se:verilog:s:-source -novopt
OPTION:mti_se:verilog:n:-source -novopt
OPTION:mti_se:verilog:c:-source -novopt
OPTION:mti_se:verilog:r:-source -novopt
OPTION:mti_se:verilog:i:-source -novopt
OPTION:mti_se:verilog:e:-novopt -quiet
#
#////////////////////////////////////
# Setup file name: ModelSim PE
SET:mti_pe:MODELSIM=modelsim.ini
#
# ModelSim PE options for VHDL Libraries
# Syntax:-
# OPTION:<simulator_name>:<language>:<library>:<options>
# <library> :- u (unisim) s (simprim) c (xilinxcorelib)
#             r (coolrunner) i (secureip) e (edk)
# vcom -work <library> <OPTION> <file_name>
#
OPTION:mti_pe:vhdl:u:-source -93 -explicit
OPTION:mti_pe:vhdl:s:-source -93 -explicit
OPTION:mti_pe:vhdl:c:-source -93 -explicit
OPTION:mti_pe:vhdl:r:-source -93 -explicit
OPTION:mti_pe:vhdl:i:-source -93 -explicit
OPTION:mti_pe:vhdl:e:-93 -novopt -quiet -explicit
#
# ModelSim PE options for VERILOG Libraries
# Syntax:-
# OPTION:<simulator_name>:<language>:<library>:<options>
# <library> :- u (unisim) s (simprim) c (xilinxcorelib)
#             r (coolrunner) i (secureip) e (edk)
# vlog -work <library> <OPTION> <file_name>
#
OPTION:mti_pe:verilog:u:-source
OPTION:mti_pe:verilog:s:-source
OPTION:mti_pe:verilog:n:-source
OPTION:mti_pe:verilog:c:-source
OPTION:mti_pe:verilog:r:-source
OPTION:mti_pe:verilog:i:-source
OPTION:mti_pe:verilog:e:-novopt -quiet
#
#////////////////////////////////////
# Setup file name: ModelSim DE
SET:mti_de:MODELSIM=modelsim.ini
#
# ModelSim DE options for VHDL Libraries
# Syntax:-
# OPTION:<simulator_name>:<language>:<library>:<options>
# <library> :- u (unisim) s (simprim) c (xilinxcorelib)
#             r (coolrunner) i (secureip) e (edk)
# vcom -work <library> <OPTION> <file_name>
#
OPTION:mti_de:vhdl:u:-source -93 -novopt -explicit
OPTION:mti_de:vhdl:s:-source -93 -novopt -explicit
OPTION:mti_de:vhdl:c:-source -93 -novopt -explicit
OPTION:mti_de:vhdl:r:-source -93 -novopt -explicit
OPTION:mti_de:vhdl:i:-source -93 -novopt -explicit
OPTION:mti_de:vhdl:e:-93 -novopt -quiet -explicit
#
# ModelSim DE options for VERILOG Libraries
# Syntax:-
# OPTION:<simulator_name>:<language>:<library>:<options>
# <library> :- u (unisim) s (simprim) c (xilinxcorelib)

```

```

#           r (coolrunner) i (secureip) e (edk)
# vlog -work <library> <OPTION> <file_name>
#
OPTION:mti_de:verilog:u:-source -novopt
OPTION:mti_de:verilog:s:-source -novopt
OPTION:mti_de:verilog:n:-source -novopt
OPTION:mti_de:verilog:c:-source -novopt
OPTION:mti_de:verilog:r:-source -novopt
OPTION:mti_de:verilog:i:-source -novopt
OPTION:mti_de:verilog:e:-novopt -quiet
#
#////////////////////////////////////
# Setup file name: QuestaSim
SET:questa:MODELSIM=modelsim.ini
#
# QuestaSim options for VHDL Libraries
# Syntax:-
# OPTION:<simulator_name>:<language>:<library>:<options>
# <library> :- u (unisim) s (simprim) c (xilinxcorelib)
#           r (coolrunner) i (secureip) e (edk)
# vcom -work <library> <OPTION> <file_name>
#
OPTION:questa:vhdl:u:-source -93 -novopt -explicit
OPTION:questa:vhdl:s:-source -93 -novopt -explicit
OPTION:questa:vhdl:c:-source -93 -novopt -explicit
OPTION:questa:vhdl:r:-source -93 -novopt -explicit
OPTION:questa:vhdl:i:-source -93 -novopt -explicit
OPTION:questa:vhdl:e:-93 -novopt -quiet -explicit
#
# QuestaSim options for VERILOG Libraries
# Syntax:-
# OPTION:<simulator_name>:<language>:<library>:<options>
# <library> :- u (unisim) s (simprim) c (xilinxcorelib)
#           r (coolrunner) i (secureip) e (edk)
# vlog -work <library> <OPTION> <file_name>
#
OPTION:questa:verilog:u:-source -novopt
OPTION:questa:verilog:s:-source -novopt
OPTION:questa:verilog:n:-source -novopt
OPTION:questa:verilog:c:-source -novopt
OPTION:questa:verilog:r:-source -novopt
OPTION:questa:verilog:i:-source -novopt
OPTION:questa:verilog:e:-novopt -quiet
#
#////////////////////////////////////
# Setup file name: ncvhdl
SET:ncsim:CDS=cds.lib
SET:ncsim:HDL=hdl.var
#
# ncvhdl options for VHDL Libraries
# Syntax:-
# OPTION:<simulator_name>:<language>:<library>:<options>
# <library> :- u (unisim) s (simprim) c (xilinxcorelib)
#           r (coolrunner) i (secureip) e (edk)
# ncvhdl -work <library> <OPTION> <file_name>
#
OPTION:ncsim:vhdl:u:-MESSAGES -v93 -RELAX -NOLOG
OPTION:ncsim:vhdl:s:-MESSAGES -v93 -RELAX -NOLOG
OPTION:ncsim:vhdl:c:-MESSAGES -v93 -RELAX -NOLOG
OPTION:ncsim:vhdl:r:-MESSAGES -v93 -RELAX -NOLOG
OPTION:ncsim:vhdl:i:-MESSAGES -v93 -RELAX -NOLOG
OPTION:ncsim:vhdl:e:-MESSAGES -v93 -RELAX -NOLOG
#
# ncvhdl options for VERILOG Libraries
# Syntax:-
# OPTION:<simulator_name>:<language>:<library>:<options>
# <library> :- u (unisim) s (simprim) c (xilinxcorelib)
#           r (coolrunner) i (secureip) e (edk)
# ncvlog -work <library> <OPTION> <file_name>
#
OPTION:ncsim:verilog:u:-MESSAGES -NOLOG
OPTION:ncsim:verilog:s:-MESSAGES -NOLOG
OPTION:ncsim:verilog:n:-MESSAGES -NOLOG

```

```

OPTION:ncsim:verilog:c:-MESSAGES -NOLOG
OPTION:ncsim:verilog:r:-MESSAGES -NOLOG
OPTION:ncsim:verilog:i:-MESSAGES -NOLOG
OPTION:ncsim:verilog:e:-MESSAGES -NOLOG
#
#////////////////////////////////////
# Setup file name: vlogan script version
SET:vcs_mx:SYNOPSYS_SIM=synopsys_sim.setup
#
# vlogan script version options for VHDL Libraries
# Syntax:-
# OPTION:<simulator_name>:<language>:<library>:<options>
# <library> :- u (unisim) s (simprim) c (xilinxcorelib)
#             r (coolrunner) i (secureip) e (edk)
# vhdlan -work <library> <OPTION> <file_name>
#
OPTION:vcs_mx:vhdl:u:-nc
OPTION:vcs_mx:vhdl:s:-nc
OPTION:vcs_mx:vhdl:c:-nc
OPTION:vcs_mx:vhdl:r:-nc
OPTION:vcs_mx:vhdl:i:-nc
OPTION:vcs_mx:vhdl:e:-nc
#
# vlogan script version options for VERILOG Libraries
# Syntax:-
# OPTION:<simulator_name>:<language>:<library>:<options>
# <library> :- u (unisim) s (simprim) c (xilinxcorelib)
#             r (coolrunner) i (secureip) e (edk)
# vlogan -work <library> <OPTION> <file_name>
#
OPTION:vcs_mx:verilog:u:+v2k -nc
OPTION:vcs_mx:verilog:s:+v2k -nc
OPTION:vcs_mx:verilog:n:+v2k -nc
OPTION:vcs_mx:verilog:c:+v2k -nc
OPTION:vcs_mx:verilog:r:+v2k -nc
OPTION:vcs_mx:verilog:i:+v2k -nc
OPTION:vcs_mx:verilog:e:+v2k -nc
#
#////////////////////////////////////
# Setup file name: Aldec
SET:riviera:LIBRARY=library.cfg
#
# Aldec options for VHDL Libraries
# Syntax:-
# OPTION:<simulator_name>:<language>:<library>:<options>
# <library> :- u (unisim) s (simprim) c (xilinxcorelib)
#             r (coolrunner) i (secureip) e (edk)
# vcom -work <library> <OPTION> <file_name>
#
OPTION:riviera:vhdl:u:-93
OPTION:riviera:vhdl:s:-93
OPTION:riviera:vhdl:c:-93
OPTION:riviera:vhdl:r:-93
OPTION:riviera:vhdl:i:-93
OPTION:riviera:vhdl:e:-93
#
# Aldec options for VERILOG Libraries
# Syntax:-
# OPTION:<simulator_name>:<language>:<library>:<options>
# <library> :- u (unisim) s (simprim) c (xilinxcorelib)
#             r (coolrunner) i (secureip) e (edk)
# vlog -work <library> <OPTION> <file_name>
#
OPTION:riviera:verilog:u:-v2k5
OPTION:riviera:verilog:s:-v2k5
OPTION:riviera:verilog:n:-v2k5
OPTION:riviera:verilog:c:-v2k5
OPTION:riviera:verilog:r:-v2k5
OPTION:riviera:verilog:i:-v2k5
OPTION:riviera:verilog:e:-v2k5
#////////////////////////////////////
# End

```

XWebTalk

This chapter describes the XWebTalk command line utility, which lets you enable or disable WebTalk data collection.

WebTalk Overview

The WebTalk feature of ISE® Design Suite helps Xilinx® understand how its customers use Xilinx FPGA devices, software, and Intellectual Property (IP). The information collected and transmitted by WebTalk helps Xilinx improve the features most important to customers as part of its continuing effort to provide products that meet your current and future needs.

When enabled, WebTalk transmits information to Xilinx after a bitstream has been generated using Project Navigator, PlanAhead™, Platform Studio, System Generator, XFLOW, or the command line, and when iMPACT is closed.

The WebTalk install preference can be set during the ISE Design Suite installation process. WebTalk user preferences can be set in ISE Design Suite, iMPACT, and PlanAhead by editing user preferences. To set WebTalk user preferences, do one of the following:

- In Project Navigator, select **Edit > Preferences > WebTalk**
- In iMPACT, select **Edit > Preferences > iMPACT > WebTalk**
- In PlanAhead™, select **Tools > Options > General**

XWebTalk lets you set both install and user preferences from the command line.

Note WebTalk is always enabled in WebPACK. WebTalk ignores user and install preference when a bitstream is generated using the WebPACK license. If a design is using a device contained in WebPACK and a WebPACK license is available, the WebPACK license will always be used. To change this, see [Answer Record 34746](#).

WebTalk Behavior for Bitstream Generation Flows

This table summarizes WebTalk behavior for data transmission back to Xilinx after bitstream generation based on your ISE Design Suite license, WebTalk install settings and WebTalk user preference settings.

Design Flow	ISE Design Suite License	WebTalk Install Preference	WebTalk User Preference	WebTalk Data Transmission to Xilinx
Bitstream generation	WebPACK	Ignored	Ignored	Yes (Send)
	Logic Edition	Enabled	Enabled	Yes (Send)
		Enabled	Disabled	No (Do not send)
		Disabled	Ignored	No (Do not send)

WebTalk Behavior for iMPACT

This table summarizes WebTalk behavior for data transmission from iMPACT to Xilinx based on your WebTalk install settings and WebTalk user preference settings. If enabled, iMPACT sends usage statistics data using WebTalk at the end of every session (when iMPACT is closed).

Design Flow	WebTalk Install Preference	WebTalk User Preference	WebTalk Data Transmission to Xilinx
iMPACT	Enabled	Enabled	Yes (Send)
	Enabled	Disabled	No (Do not send)
	Disabled	Ignored	No (Do not send)

XWebTalk Syntax

Following is the command line syntax for XWebTalk:

```
xwebtalk [options]
```

options can be any of the options listed in [XWebTalk Options](#).

XWebTalk Options

This section describes the XWebTalk command line options, and includes the following:

- [-user \(User\)](#)
- [-install \(Install\)](#)
- [-info \(Information\)](#)

-user (User)

This option lets you turn WebTalk on or off on a per user basis.

Syntax

```
-user on|off
```

on turns WebTalk on for the current user.

off turns WebTalk off for the current user.

User settings are saved in the following location:

- **Windows** - %APPDATA%\Xilinx\Common\version\webtalk where %APPDATA% is C:\Documents and Settings\user\Application Data
- **Linux** - /home/user/.Xilinx/Common/version/webtalk

Example

```
xwebtalk -user on
```

Enables WebTalk for the current user.

-install (Install)

This option lets you turn WebTalk on or off on a per-installation basis.

Syntax

`-install on|off`

on turns WebTalk on for the installation.

off turns WebTalk off for the installation.

Install settings are saved in the following location:

- **Windows** - %XILINX%\data\reports\webtalksettings
- **Linux** - \$XILINX/data/reports/webtalksettings

Note You will need administrator privileges to be able to write to the install location.

Example

```
xwebtalk -install on
```

Enables WebTalk for an installation

-info (Information)

This option lets you check the current status of WebTalk settings.

Syntax

`-info`

Example

```
xwebtalk -info
```

Lists the current WebTalk settings.

Tcl Reference

This chapter provides information on the Xilinx® Tcl command language.

Tcl Overview

Tool Command Language (Tcl) is an easy to use scripting language and an industry standard popular in the electronic design automation (EDA) industry.

The Xilinx® software Tcl command language is designed to complement and extend the ISE® graphical user interface (GUI). For new users and projects, the GUI provides an easy interface to set up a project, perform initial implementations, explore available options, set constraints, and visualize the design. Alternatively, for users who know exactly what options and implementation steps they wish to perform, the Xilinx Tcl commands provide a batch interface that makes it convenient to execute the same script or steps repeatedly. Since the syntax of the Xilinx Tcl commands match the GUI interaction as closely as possible, Xilinx Tcl commands allow an easy transition from using the GUI to running the tools in script or batch mode.

Tcl Device Support

Xilinx Tcl commands are available for use with the following device families:

- 7 series
- Spartan®-3, Spartan-3A, Spartan-3E, and Spartan-6
- Virtex®-4, Virtex-5, and Virtex-6
- CoolRunner™ XPLA3 and CoolRunner-II
- XC9500 and XC9500XL

The Xilinx Tcl Shell

To access the xtclsh from the command line, type **xtclsh** from the command prompt to return the xtclsh prompt (%).

```
> xtclsh
%
```

Command line syntax is based on the Tcl command and corresponding subcommand that you enter.

```
% tcl_command subcommand optional_arguments
```

tcl_command is the Tcl command name.

subcommand is the subcommand name for the Xilinx Tcl command.

optional_arguments are the arguments specific to each subcommand.

Example syntax for all Xilinx Tcl commands, subcommands, and their respective arguments is included in the [Tcl Commands for General Use](#) and [Tcl Commands for Advanced Scripting](#) sections in this chapter.

Accessing Help for Xilinx Tcl Commands

Use the **help** command to get detailed information on Xilinx-specific Tcl commands. From the xtclsh prompt (%), type **help** for a list and brief description of Xilinx Tcl commands. For help on a specific Tcl command, type the following:

```
% help <tcl_command>
```

You can also get information on a specific subcommand by typing the subcommand name after the Tcl command. For example, type the following to get help on creating a new ISE project:

```
% help project new
```

help is the command that calls the Tcl help information.

project specifies the Tcl command name.

new specifies the subcommand name about which you wish to obtain help.

Note The Tcl **help** command is case-sensitive. Typing **HELP** as opposed to **help** in the xtclsh or Tcl Console panel will list available OS commands.

Tcl Fundamentals

Each Tcl command is a series of words, with the first word being the command name. For Xilinx Tcl commands, the command name is either a noun (e.g., **project**) or a verb (e.g., **search**). For commands that are nouns, the second word on the command line is the verb (e.g., **project open**). This second word is called the subcommand.

Subsequent words on the command line are additional parameters to the command. For Xilinx Tcl commands, required parameters are positional, which means they must always be specified in an exact order and follow the subcommand. Optional parameters follow the required parameters, can be specified in any order, and always have a flag that starts with "-" to indicate the parameter name; for example, **-instance <instance-name>**.

Tcl is case sensitive. Xilinx® Tcl command names are always lower case. If the name is two words, the words are joined with an underscore (_). Even though Tcl is case sensitive, most design data (e.g., an instance name), property names, and property values are case insensitive. To make it less burdensome to type at the command prompt, unique prefixes are recognized when typing a subcommand, which means only typing the first few letters of a command name is all that is required for it to be recognized.

To get the most from this Tcl reference, it is best to understand some standard Tcl commands.

- **set** - Used to assign values to variables and properties. **set** takes 2 arguments: the name of the variable followed by the argument to be assigned to that variable. Since Tcl variables are "type-less", it is not necessary to declare a variable or its type before using it.

```
% set fruit apple; # assigns the value "apple" to the variable named "fruit"
```
- **\$ (dollar sign)** - Used to substitute a variable's value for its name. Using the previous example, consider the variable's name as well as its value:

```
% puts fruit; # this prints the word "fruit"  
  
% puts $fruit; # this prints the value of the variable fruit:  
the word "apple."
```
- **[] (square brackets)** - The result of one command can be substituted directly as input into another command. Using the square brackets, you can nest commands, because Tcl interprets everything between the brackets and substitutes its result.
- **more substitution** - Tcl provides several ways to delimit strings that contain spaces or other special characters and to manage substitution. Double quotes (") allow some special characters ([] and \$) for substitution. Curly braces { } perform no substitutions.
- **Tcl and backslashes** - The backslash (\) has a special meaning in Tcl, thus it will not behave as you expect if you paste DOS style path names, which contain backslashes, into Tcl commands. It is recommended that you specify all path names using forward slashes within Tcl commands and scripts.

The real power of Tcl is unleashed when it is used for nested commands and for scripting. The result of any command can be stored in a variable, and the variable (or the command result substituted within square brackets) can be nested as input to other commands.

For more information about Tcl in general, please refer to Tcl documentation easily available on the internet, for example: <http://www.tcl.tk/doc/>, which is the website for the Tcl Developer Xchange. If you wish to review sample scripts made up of standard Tcl commands, refer to "Sample Standard Tcl Scripts" within the [Example Tcl Scripts](#) section at the end of this chapter. Further tutorials and examples are available at the Tcl Developer Xchange: <http://www.tcl.tk/man/tcl8.5/tutorial/tcltutorial.html>.

Xilinx Namespace

All Xilinx® Tcl commands are part of the Tcl namespace `xilinx::`. If another Tcl package uses a command name that conflicts with a Xilinx-specific Tcl command name, the Xilinx namespace must be used to access the command. For example, type the following to create a new project using Xilinx-specific Tcl commands:

```
% xilinx::project new <project_name>
```

It is only necessary to specify the Xilinx namespace when you have more than one namespace installed.

Project and Process Properties

This section contains tables that list Project and Process Properties available as options to the Tcl commands.

The first table below lists the project properties that apply to your project, independent of any processes. The remaining tables list all of the process properties, which are supported batch tool options grouped into separate tables for the software process with which they are associated

Note In many cases, the properties listed in the following tables are *dependent* properties. This means that a particular property setting may not be available unless a different, related property has been set. If you try to set a property, yet it is not available, a warning message will inform you that it is dependent on another property.

Project Properties

Project Properties

Property Name	Description
family	The device family into which you will implement your design. For allowed values, see the <code>-arch</code> option in the PARTGen chapter of this guide.
device	The device (within previously-specified device family) to use for the project.
package	The package (available for previously-specified device) to use for the project.
speed	The device speed grade.
"Top-Level Source Type" or top_level_module_type	The source type of the top-level module in your design. Choices are: HDL, EDIF, Schematic, and NGC/NGO.
"Synthesis Tool" or synthesis_tool	The synthesis tool for ISE® Design Suite to use when synthesizing your sources. The default is XST, but partner synthesis tools are available if they are installed.
Simulator	Specify the integrated simulator for the ISE Design Suite to use (ISim), or specify from a larger selection of external simulators as target for ISE Design Suite-generated simulation netlists and files.
"Preferred Language"	The HDL language that you wish the ISE Design Suite to use when generating simulation netlists and other intermediate files. If your synthesis tool and simulator only support one language, that is your default.
Top	Identify which source file is the top-level module in your design hierarchy.
name	Name of the project
"Use SmartGuide"	Enables or disables SmartGuide™ functionality. Choices are: TRUE or FALSE.
"SmartGuide Filename"	If you wish to specify a different guide file (other than the default previous placed and routed NCD), you may specify the file with this property. The value must be a placed and routed NCD file. This is a dependent property on the "Use SmartGuide" property.

Process Properties - Synthesize Process

The following table of XST Process Properties can be used with `project set` and `project get` with `-process "Synthesize - XST"`.

Synthesize - XST Process Properties

Note the values listed in this table are associated with xst processes when applied to Virtex5 devices. In a few cases, values may differ for other devices.

Note the "command-line equivalent" column is intended not as an explanation of the shell command-line syntax, but as a reference should you wish to refer to this equivalent argument elsewhere in this guide.

Property Name	Type	Allowed Values in Tcl	Default Value	XST Command-Line Equivalent
"Asynchronous to Synchronous"	boolean	TRUE, FALSE	FALSE	<code>-async_to_sync</code>
"Add I/O Buffers"	boolean	TRUE, FALSE	TRUE	<code>-iobuf</code>
"Automatic BRAM Packing"	boolean	TRUE, FALSE	FALSE	<code>-auto_bram_packing</code>
"BRAM Utilization Ratio"	range	-1 to 100	100	<code>-bram_utilization_ratio</code>
"Bus Delimiter"	list	<>, [], {}, ()	<>	<code>-bus_delimiter</code>
"Case Implementation Style"	list	"None", "Full", "Parallel", "Full-Parallel"	"None"	<code>-vlgcase</code>
"Case"	list	"Maintain", "Lower", "Upper"	"Maintain"	<code>-case</code>
"Cores Search Directories"	filenames			<code>-sd</code>
"Cross Clock Analysis"	boolean	TRUE, FALSE	FALSE	<code>-cross_clock_analysis</code>
"Decoder Extraction" <i>(S3/A/E/V4/V5 only)</i>	boolean	TRUE, FALSE	TRUE	<code>-decoder_extract</code>
"DSP Utilization Ratio" <i>(S3ADSP/V4/S6/V5/V6/7 series only)</i>	range	-1 to 100	100	<code>-dsp_utilization_ratio</code>
"Equivalent Register Removal"	boolean	TRUE, FALSE	TRUE	<code>-equivalent_register_removal</code>
"FSM Encoding Algorithm"	list	"Auto", "One-Hot", "Compact", "Sequential", "Gray", "Johnson", "User", "Speed1", "None"	"Auto"	<code>-fsm_extract</code> <code>-fsm_encoding</code>
"FSM Style"	list	"LUT", "Bram"	"LUT"	<code>-fsm_style</code>
"Generate RTL Schematic"	list	"Yes", "No", "Only"	"Yes"	<code>-rtlview</code>
"Generics, Parameters"	string			<code>-generics</code>

Property Name	Type	Allowed Values in Tcl	Default Value	XST Command-Line Equivalent
"Global Optimization Goal"	list	"AllClockNets", "Inpad To Outpad", "Offset In Before", "Offset Out After", "Maximum Delay"	"AllClockNets"	-glob_opt
"HDL INI File"	filename			-xsthdpini
"Hierarchy Separator"	list	"/" or "_"	"/"	-hierarchy_separator
"Keep Hierarchy"	list	"No", "Yes", "Soft"	"No"	-keep_hierarchy
"Library for Verilog Sources" (S6/V6/7 series only)	string			
"Library Search Order"	filenames	.lso files		-lso
"Logical Shifter Extraction" (S3/A/E/V4/V5 only)	boolean	TRUE, FALSE	TRUE	-shift_extract
"LUT Combining" (S6/V5/V6/7 series only)	list	"No", "Auto", "Area"	"No" (V5); "Auto" (S6/V6/7 series)	-lc
"LUT-FF Pairs Utilization Ratio" (S6/V5/V6/7 series only)	range	-1 to 100	100	-slice_utilization_ratio
"Max Fanout"	range	0 - 10000+	100,000 (S6/V5/V6/7 series); 500 (S3/A/E/V4)	-max_fanout
"Move First Flip-Flop Stage"	boolean	TRUE, FALSE	[dependent]	-move_first_stage
"Move Last Flip-Flop Stage"	boolean	TRUE, FALSE	[dependent]	-move_last_stage
"Multiplier Style" (S3/S3E/S3A only)	list	"Auto", "Block", "LUT", "Pipe_LUT"	"Auto"	-mux_style
"Mux Extraction" (S3/A/E/V4/V5 only)	list	"Yes", "No", "Force"	"Yes"	-mux_extract
"Mux Style" (S3/A/E/V4/V5 only)	list	"Auto", "MUXF", "MUXCY"	"Auto"	-mux_style
"Netlist Hierarchy"	list	"As Optimized", "Rebuilt"	"As Optimized"	-netlist_hierarchy
"Number of Clock Buffers" (all but V4)	range	0 - 32	32	-bufg
"Number of Global Clock Buffers" (V4)	range	0 - 32	32	-bufg
"Number of Regional Clock Buffers" (V4)	range	0 - 16	16	-bufr
"Optimization Effort"	list	"Normal", "High", "Fast"* (*S6/V6/7 series only)	"Normal"	-opt_level
"Optimization Goal"	list	"Speed", "Area"	"Speed"	-opt_mode

Property Name	Type	Allowed Values in Tcl	Default Value	XST Command-Line Equivalent
"Optimize Instantiated Primitives"	boolean	TRUE, FALSE	FALSE	<code>-optimize_primitives</code>
"Other XST Command Line Options"	text string	any legal command-line equivalent arguments that are not already set through other properties	none	none
"Pack I/O Registers into IOBs"	list	"Auto", "Yes", "No"	"Auto"	<code>-iob</code>
"Power Reduction" (S6/V4/V5/V6/7 series only)	boolean	TRUE, FALSE	FALSE	<code>-power</code>
"Priority Encoder Extraction" (S3/A/E/V4/V5 only)	list	"Yes", "No", "Force"	"Yes"	<code>-priority_extract</code>
"RAM Extraction"	boolean	TRUE, FALSE	TRUE	<code>-ram_extract</code>
"RAM Style"	list	"Auto", "Distributed", "Block"	"Auto"	<code>-ram_style</code>
"Read Cores"	list	"Yes", "No"	"Yes"	<code>-read_cores</code>
"Reduce Control Sets" (S6/V5/V6/7 series only)	list	"No", "Auto"	"No" (V5); "Auto" (S6/V6/7 series)	<code>-reduce_control_sets</code>
"Register Balancing"	list	"No", "Yes", "Forward", "Backward"	"No"	<code>-register_balancing</code>
"Register Duplication"	boolean	TRUE, FALSE	TRUE	<code>-register_duplication</code>
"Resource Sharing"	boolean	TRUE, FALSE	TRUE	<code>-resource_sharing</code>
"ROM Extraction"	boolean	TRUE, FALSE	TRUE	<code>-rom_extract</code>
"ROM Style"	list	"Auto", "Distributed", "Block"	"Auto"	<code>-rom_style</code>
"Safe Implementation"	list	"No", "Yes"	"No"	<code>-safe_implementation</code>
"Shift Register Extraction"	boolean	TRUE, FALSE	TRUE	<code>-shreg_extract</code>
"Shift Register Minimum Size" (S6/V6/7 series only)	string		"2"	
"Slice Packing" (S3/A/E/V4/V5 only)	boolean	TRUE, FALSE	TRUE	<code>-slice_packing</code>
"Slice Utilization Ratio" (S3/A/E/V4 only)	range	-1 to 100	100	<code>-slice_utilization_ratio</code>
"Synthesis Constraints File"	filename			<code>-uc</code>

Property Name	Type	Allowed Values in Tcl	Default Value	XST Command-Line Equivalent
"Use Clock Enable"	list	"Auto", "Yes", "No"	"Auto" (V4/V5); "Yes" (S3/A/E/S6/V6 /7 series)	-use_clock_enable
"Use DSP Block"	list	"Auto", "Yes", "No"	"Auto"	-use_dsp48
"Use Synchronous Reset"	list	"Auto", "Yes", "No"	"Auto" (S6/V4/V5/V6 /7 series); "Yes" (S3/A/E)	-use_sync_reset
"Use Synchronous Set"	list	"Auto", "Yes", "No"	"Auto" (S6/V4/V5/V6 /7 series); "Yes" (S3/A/E)	-use_sync_set
"Use Synthesis Constraints File"	boolean	TRUE, FALSE	TRUE	-iuc
"Verilog 2001" (S3/A/E/V4/V5 only)	boolean	TRUE, FALSE	TRUE	-verilog2001
"Verilog Include Directories"	filenames			-vlgindir
"Verilog Macros"	text string			use with -define
"Work Directory"	filename		<code>./xst</code>	-xsthdpdir
"Write Timing Constraints"	boolean	TRUE, FALSE	FALSE	-write_timing_constraints
"XOR Collapsing" (S3/A/E/V4/V5 only)	boolean	TRUE, FALSE	TRUE	-xor_collapse

Process Properties - Translate Process

The following table of Translate (NGDBuild) Process Properties can be used with `project set` and `project get` with `-process Translate`.

Translate Process Properties

Note the values listed in this table are associated with NGDBuild processes when applied to Virtex5 devices. In a few cases, values may differ for other devices.

Note the "command-line equivalent" column is intended not as an explanation of the shell command-line syntax, but as a reference should you wish to refer to this equivalent argument elsewhere in this guide.

Property Name	Type	Allowed Values in Tcl	Default Value	NGDBuild Command-Line Equivalent
"Allow Unexpanded Blocks"	boolean	TRUE, FALSE	FALSE	<code>-u</code>
"Allow Unmatched LOC Constraints"	boolean	TRUE, FALSE	FALSE	<code>-aul</code>
"Allow Unmatched Timing Group Constraints"	boolean	TRUE, FALSE	FALSE	<code>-aut</code>
"Create I/O Pads from Ports"	boolean	TRUE, FALSE	FALSE	<code>-a</code>
"Macro Search Path"	filenames	filenames separated with " " separator		<code>-sd</code>
"Netlist Translation Type"	list	"Timestamp", "On", "Off"	"Timestamp"	<code>-nt</code>
"Other NGDBuild Command Line Options"	text string	any legal command-line equivalent arguments that are not already set through other properties	none	none
"Use LOC Constraints"	boolean	TRUE, FALSE	TRUE	<code>-r</code> means FALSE
"User Rules File for Netlister Launcher"	filename	--	--	<code>-ur</code>

Process Properties - Map Process

The following table of Map Process Properties can be used with `project set` and `project get` with `-process Map`.

Map Process Properties

Note the values listed in this table are associated with map processes when applied to Virtex®-5 devices. In a few cases, values may differ for other devices.

Note the "command-line equivalent" column is intended not as an explanation of the shell command-line syntax, but as a reference should you wish to refer to this equivalent argument elsewhere in this guide.

Property Name	Type	Allowed Values in Tcl	Default Value	MAP Command-Line Equivalent
"Allow Logic Optimization Across Hierarchy"	boolean	TRUE, FALSE	FALSE	<code>-ignore_keep_hierarchy</code>
"CLB Pack Factor Percentage" (S3/A/E/V4 only)	range	0-100	100	<code>-c</code>
"Combinatorial Logic Optimization"	boolean	TRUE, FALSE	FALSE	<code>-logic_opt</code>
"Register Ordering" (S6/V6/7 series only)	list	"Off", "4", "8"	"4"	<code>-r</code>
"Enable Multi-Threading" (S6/V5/V6/7 series only)	list	"Off", "2"	"Off"	<code>-mt</code>
"Equivalent Register Removal" (S6/V4/V5/V6/7 series only)	boolean	TRUE, FALSE	TRUE (dependent)	<code>-equivalent_register_removal</code>
"Extra Cost Tables" (S6/V6/7 series only)	list	"0"-"5"	"0"	<code>-xt</code>
"Extra Effort" (S3/A/E/V4 only)	list	"None", "Normal", "Continue on Impossible"	"None"	<code>-xe</code>
"Generate Detailed MAP Report"	boolean	TRUE, FALSE	FALSE	<code>-detail</code>
"Global Optimization" (S6/V4/V5/V6/7 series only)	list	"Off", "Speed", "Area", "Power" (Area and Power not for V4)	"Off"	<code>-global_opt</code>
"Ignore User Timing Constraints" (also see Timing Mode)	boolean	TRUE, FALSE	FALSE	<code>-ntd</code> <code>-x</code> (for Virtex-5 devices)
"LUT Combining" (S6/V5/V6/7 series only)	list	"Off", "Auto", "Area"	"Off"	<code>-lc</code> (off, auto, area)
"Map Effort Level" (dependent property) (S3/A/E/V4 only)	list	"Standard", "High"	"Standard"	<code>-ol</code>

Property Name	Type	Allowed Values in Tcl	Default Value	MAP Command-Line Equivalent
"Map Slice Logic into Unused Block RAMs"	boolean	TRUE, FALSE	FALSE	-bp
"Maximum Compression" <i>(S6/V5/V6/7 series only)</i>	boolean	TRUE, FALSE	FALSE	-c
"Optimization Strategy (Cover Mode)" <i>(S3/A/E/V4/V5 only)</i>	list	"Area", "Speed", "Balanced", "Off"	"Area"	-cm
"Other Map Command Line Options"	text string	any legal command-line equivalent arguments that are not already set through other properties	none	none
"Pack I/O Registers/Latches into IOBs"	list	"For Inputs and Outputs", "For Inputs Only", "For Outputs Only", "Off"	"Off"	-pr
"Perform Timing-Driven Packing and Placement" <i>(S3/A/E/V4 only)</i>	boolean	TRUE, FALSE	FALSE	-timing
"Placer Effort Level" <i>(S6/V5/V6/7 series only)</i>	list	"Standard", "High"	"High"	-ol
"Placer Extra Effort" <i>(dependent property)</i> <i>(S6/V5/V6/7 series only)</i>	list	"None", "Normal", "Continue on Impossible"	"None"	-xe
"Power Activity File" <i>(dependent on Power Reduction)</i>	filename			-activityfile
"Power Reduction"	list	"Off", "On", "High", "Extra Effort" <i>(High, Extra Effort S6/V6/7 series only)</i>	"Off"	-power
"Register Duplication"	list	"Off", "On"	"Off"	-register_duplication
"Starting Placer Cost Table (1-100)"	range	1-100	1	-t
"Timing Mode" <i>(dependent property, related to Ignore User Timing Constraints)</i>	list	"Performance Evaluation", "Non Timing Driven"	"Performance Evaluation"	see -ntd and -x
"Trim Unconnected Signals"	boolean	TRUE, FALSE	TRUE	-u
"Use RLOC Constraints"	list	"Yes", "No", "For Packing Only"	"Yes"	-ir
"Ignore User Timing Constraints"	boolean	TRUE, FALSE	FALSE	-x

Process Properties - Place and Route Process

The following table of Place and Route (PAR) Process Properties can be used with `project set` and `project get` with `-process "Place & Route"`.

Place and Route (PAR) Process Properties

Note the values listed in this table are associated with PAR processes when applied to Virtex®-4 devices. In some cases, values may differ for other devices.

Note the "command-line equivalent" column is intended not as an explanation of the shell command-line syntax, but as a reference should you wish to refer to this equivalent argument elsewhere in this guide.

Property Name	Type	Allowed Values in Tcl	Default Value	PAR Command-Line Equivalent
"Enable Multi-Threading" (S6/V5/V6/7 series only)	list	"Off", "2", "3", "4"	"Off"	<code>-mt</code>
"Extra Effort (Highest PAR level only)" (dependent property, only available if Highest PAR level set)	list	"None", "Normal", "Continue on Impossible"	"None"	<code>-xe</code>
"Generate Asynchronous Delay Report"	boolean	TRUE, FALSE	FALSE	<code>-delay</code> (ReportGen)
"Generate Clock Region Report"	boolean	TRUE, FALSE	FALSE	<code>-clock_regions</code> (ReportGen)
"Generate Post-Place & Route Simulation Model"	boolean	TRUE, FALSE	FALSE	<code>netgen process</code>
"Ignore User Timing Constraints" (also see Timing Mode)	boolean	TRUE, FALSE	FALSE	<code>-ntd</code> <code>-x</code> (for Virtex-5 devices)
"Other Place & Route Command Line Options"	text string	any legal command-line equivalent arguments that are not already set through other properties	none	none
"Place & Route Effort Level (Overall)"	list	"Standard", "High"	"Standard"	<code>-ol</code>
"Place and Route Mode"	list	"Normal Place and Route", "Place Only", "Route Only", "Reentrant Route" (<i>"Normal Place and Route" and "Place Only" S3/A/E/V4 only</i>)	"Normal Place and Route" (S3/A/E/V4); "Route Only" (S6/V5/V6/7 series)	Different selections correspond to options: <code>-r</code> , <code>-p</code> , <code>-k</code>
"Placer Effort Level (Overrides Overall Level)" (S3/A/E/V4 only)	list	"None", "Standard", "High"	"None"	<code>-pl</code>
"Power Activity File"	filename			<code>-activityfile</code>
"Power Reduction"	boolean	TRUE, FALSE	FALSE	<code>-power</code>

Property Name	Type	Allowed Values in Tcl	Default Value	PAR Command-Line Equivalent
"Router Effort Level (Overrides Overall Level)" <i>(S3/A/E/V4 only)</i>	list	"None", "Standard", "High"	"None"	-rl
"Starting Placer Cost Table (1-100)" <i>(S3/A/E/V4 only)</i>	range	1-100	1	-t
"Timing Mode" <i>(dependent property, related to Ignore User Timing Constraints)</i>	list	"Performance Evaluation", "Non Timing Driven"	"Performance Evaluation"	see -ntd and -x

Process Properties - Generate Programming File Process

The following table of Generate Programming File (BitGen) Process Properties can be used with `project set` and `project get` with `-process "Generate Programming File"`.

Generate Programming File Process Properties

Note Properties for this process are very device-dependent. In the interest of space, the following table lists property name and some of the device families appropriate to the property, with the values listed for one device only (Virtex®-5 devices when appropriate). This table should not be considered a device-specific instruction for these properties. Please consult the specific BitGen options in the [BitGen Command Line Options section](#) of this guide for detailed information.

Note the "command-line equivalent" column is intended not as an explanation of the shell command-line syntax, but as a reference should you wish to refer to this equivalent argument elsewhere in this guide.

Property Name	Type	Allowed Values in Tcl	Default Value	BitGen Command Line Equivalent
"AES Initial Vector" (S6/V4/V5/V6/7 series only)	string	hex string		<code>-g startCBC</code>
"AES Key (Hex String)" (S6/V4/V5/V6/7 series only)	string	hex string	[empty]	<code>-g Key0</code>
"Allow SelectMAP Pins to Persist"	boolean	TRUE, FALSE	FALSE	<code>-g Persist</code>
"BPI Reads Per Page" (V5/V6/7 series only)	list	1, 4, 8	1	<code>-g BPI_page_size</code>
"Configuration Clk (Configuration Pins)" (S3/V4/V5/V6/7 series only)	list	"Pull Up", "Float"	"Pull Up"	<code>-g CclkPin</code>
"Configuration Pin Busy" (V4/V5/V6 only)	list	"Pull Up", "Float", "Pull Down"	"Pull Up"	<code>-g BusyPin</code>
"Configuration Pin CS" (V4/V5/V6 only)	list	"Pull Up", "Float", "Pull Down"	"Pull Up"	<code>-g CspPin</code>
"Configuration Pin Din" (V4/V5/V6 only)	list	"Pull Up", "Float", "Pull Down"	"Pull Up"	<code>-g DinPin</code>
"Configuration Pin Done"	list	"Pull Up", "Float"	"Pull Up"	<code>-g DonePin</code>
"Configuration Pin HSWAPEN" (S3/V4/V5/V6/S6 only)	list	"Pull Up", "Float", "Pull Down"	"Pull Up"	<code>-g HswapenPin</code>
"Configuration Pin Init" (V4/V5/V6/7 series only)	list	"Pull Up", "Float"	"Pull Up"	<code>-g InitPin</code>

Property Name	Type	Allowed Values in Tcl	Default Value	BitGen Command Line Equivalent
"Configuration Pin M0" (S3/V4/V5/V6/7 series only)	list	"Pull Up", "Float", "Pull Down"	"Pull Up"	-g M0Pin
"Configuration Pin M1" (S3/V4/V5/V6/7 series only)	list	"Pull Up", "Float", "Pull Down"	"Pull Up"	-g M1Pin
"Configuration Pin M2" (S3/V4/V5/V6/7 series only)	list	"Pull Up", "Float", "Pull Down"	"Pull Up"	-g M2Pin
"Configuration Pin Powerdown" (V4 only)	list	"Pull Up", "Float"	"Pull Up"	-g PowerdownPin
"Configuration Pin Program"	list	"Pull Up", "Float"	"Pull Up"	-g ProgPin
"Configuration Pin RdWr" (V4/V5/V6 only)	list	"Pull Up", "Float", "Pull Down"	"Pull Up"	-g RdWrPin
"Configuration Rate"	list	2, 6, 9, 13, 17, 20, 24, 27, 31, 35, 38, 42, 46, 49, 53, 56, 60	2	-g ConfigRate
"Create ASCII Configuration File"	boolean	TRUE, FALSE	FALSE	-b
"Create Binary Configuration File"	boolean	TRUE, FALSE	FALSE	-g Binary
"Create Bit File"	boolean	TRUE, FALSE	TRUE	-j
"Create IEEE 1532 Configuration File"	boolean	TRUE, FALSE	FALSE	-g IEEE1532
"Create Logic Allocation File" (dependent)	boolean	TRUE, FALSE	FALSE	-l
"Create Mask File"	boolean	TRUE, FALSE	FALSE	-m
"Create ReadBack Data Files"	boolean	TRUE, FALSE	FALSE	-g Readback
"Cycles for First BPI Page Read" (V5/V6/7 series only)	list	1, 2, 3, 4	1	-g BPI_1st_read_cycle
"DCI Update Mode" (S3/V4/V5/V6/7 series only)	list	"As Required", "Continuous", "Quiet(Off)"	"As Required"	-g DCIUpdateMode
"Disable JTAG Connection" (V6/7 series only)	boolean	TRUE, FALSE	FALSE	-g Disable_JTAG
"Done (Output Events)"	list	"Default (4)", 1, 2, 3, 4, 5, 6	"Default (4)"	-g DONE_cycle
"Drive Awake Pin During Suspend / Wake Sequence"	boolean	TRUE, FALSE	FALSE	-g Drive_aware

Property Name	Type	Allowed Values in Tcl	Default Value	BitGen Command Line Equivalent
"Drive Done Pin High"	boolean	TRUE, FALSE	FALSE	-g DriveDone
"Enable BitStream Compression"	boolean	TRUE, FALSE	FALSE	-g Compress
"Enable Cyclic Redundancy Checking (CRC)"	boolean	TRUE, FALSE	TRUE	-g CRC
"Enable Debugging of Serial Mode BitStream"	boolean	TRUE, FALSE	FALSE	-g DebugBitstream
"Enable External Master Clock" (S6 only)	boolean	TRUE, FALSE	FALSE	-g ExtMasterCclk_en
"Enable Filter on Suspend Input" (S3A only)	boolean	TRUE, FALSE	TRUE	-g Suspend_filter
"Enable Internal Done Pipe"	boolean	TRUE, FALSE	FALSE	-g DonePipe
"Enable Outputs (Output Events)"	list	"Default (5)", "1", "2", "3", "4", "5", "6", "Done", "Keep"	"Default (5)"	-g DONE_cycle
"Enable Power-On Reset Detection" (S3A only)	boolean	TRUE, FALSE	TRUE	-g en_porb
"Enable Suspend/Wake Global Set/Reset" (S3A/S6 only)	boolean	TRUE, FALSE	FALSE	-g en_sw_gsr
"Encrypt Bitstream" (S6/V4/V5/V6/7 series only)	boolean	TRUE, FALSE	FALSE	-g Encrypt
"Encrypt Key Select" (S6/V6/7 series only)	list	"BBRAM", "eFUSE"	"BBRAM"	-g EncryptKeySelect
"Essential Bits" (all except Stacked Silicon Interconnect devices)	boolean	TRUE, FALSE	FALSE	-g EssentialBits
"Fallback Reconfiguration" (V5/V6/7 series only)	list	"Enable", "Disable"	"Enable"	-g ConfigFallback
"FPGA Start-Up Clock"	list	"CCLK", "User Clock", "JTAG Clock"	"CCLK"	-g StartupCclk
"GTS Cycle During Suspend / Wakeup Sequence" (S3A/S6 only)	range	1 - 1024	4	-g sw_gts_cycle
"GWE Cycle During Suspend / Wakeup Sequence" (S3A/S6 only)	range	1 - 1024	5	-g sw_gwe_cycle

Property Name	Type	Allowed Values in Tcl	Default Value	BitGen Command Line Equivalent
"HMAC Key (Hex String)" <i>(V6/7 series only)</i>	string		[empty]	-g HKey
"Internal RS[1:0] Value" <i>(7 series only)</i>	binary	00, 01, 10, 11	00	-g RevisionSelect
"Input Encryption Key File" <i>(S6/V4/V5/V6/7 series only)</i>	filename			-g KeyFile
"JTAG Pin TCK"	list	"Pull Up", "Float", "Pull Down"	"Pull Up"	-g TckPin
"JTAG Pin TDI"	list	"Pull Up", "Float", "Pull Down"	"Pull Up"	-g TdiPin
"JTAG Pin TDO"	list	"Pull Up", "Float", "Pull Down"	"Pull Up"	-g TdoPin
"JTAG Pin TMS"	list	"Pull Up", "Float", "Pull Down"	"Pull Up"	-g TmsPin
"JTAG to System Monitor Connection" <i>(V5/V6/7 series only)</i>	list	"Enable", "Disable"	"Enable"	-g JTAG_SysMon
"Match Cycle" <i>(V5/V6/7 series only)</i>	list	"Auto", "0", "1", "2", "3", "4", "5", "6", "NoWait"	"Auto"	-g Match_cycle
"MultiBoot: Next Configuration Mode" <i>(dependent)</i> <i>(S3A/S6 only)</i>	string	hex string	0x001	-g next_config_boot_mode
"MultiBoot: Starting Address for Golden Configuration" <i>(dependent)</i> <i>(S6 only)</i>	string	hex string	0x00000000	-g golden_config_addr
"MultiBoot: Starting Address for Next Configuration" <i>(dependent)</i> <i>(S3A/S6 only)</i>	string	hex string	0x00000000	-g next_config_addr
"MultiBoot: Use New Mode for Next Configuration" <i>(dependent)</i> <i>(S3A/S6 only)</i>	boolean	TRUE, FALSE	TRUE	-g next_config_new_mode
"MultiBoot: User-Defined Register for Failsafe Scheme" <i>(dependent)</i> <i>(S6 only)</i>	string	hex string	0x0000	-g failsafe_user

Property Name	Type	Allowed Values in Tcl	Default Value	BitGen Command Line Equivalent
"Other BitGen Command Line Options"	text string	any legal command-line equivalent arguments that are not already set through other properties	none	none
"Place MultiBoot Settings into Bitstream" (S3A/S6 only)	boolean	TRUE, FALSE	FALSE	
"Power Down Device if Over Safe Temperature" (V5 only)	boolean	TRUE, FALSE	FALSE	-g OverTempPowerDown
"Release Write Enable (Output Events)"	list	"Default (6)", "1", "2", "3", "4", "5", "6", "Done", "Keep"	"Default (6)"	-g GWE_cycle
"Reset DCM if SHUTDOWN & AGHIGH performed" (S3/E only)	boolean	TRUE, FALSE	FALSE	-g DCMSHUTDOWN
RS[1:0] Tristate Enable (7 series only)	boolean	TRUE, FALSE	FALSE	-g RevisionSelect_tristate
"Run Design Rules Checker (DRC)"	boolean	TRUE, FALSE	TRUE	-d
"Security"	list	"Enable Readback and Reconfiguration", "Disable Readback", "Disable Readback and Reconfiguration"	"Enable Readback and Reconfiguration"	-g Security
"SelectMAP Abort Sequence" (V5 only)	list	"Enable", "Disable"	"Enable"	-g SelectMAPAbort
"Setup External Master Clock Division" (S6 only)	list	"1", "2"-1022" (even numbers)	"1" [dependent]	-g ExtMasterCclk_divide
"Set SPI Configuration Bus Width" (S6 only)	list	"1", "2", "4"	"1"	-g SPI_buswidth
"Starting Address for Fallback Configuration" (V6/7 series only)	string	hex string	0x00000000	-g next_config_addr
"Unused IOB Pins"	list	"Pull Down", "Float", "Pull Up"	"Pull Down"	-g UnusedPin
"UserID Code (8 Digit Hexadecimal)"	string	8-digit hexadecimal digit	0xFFFFFFFF	-g UserID

Property Name	Type	Allowed Values in Tcl	Default Value	BitGen Command Line Equivalent
"Wait for DCI Match (Output Events)" <i>(S3/V4/V5/V6/7 series only)</i>	list	"0", "1", "2", "3", "4", "5", "6", "NoWait", "Auto"	"Auto"	-g Match_cycle
"Wait for DLL Lock (Output Events)" <i>(S3/A/E/V4/V5)</i>	list	"0", "1", "2", "3", "4", "5", "6", "NoWait"	"NoWait"	-g LCK_cycle
"Wait for DLL and PLL Lock (Output Events)" <i>(S6/V6/7 series only)</i>	list	"0", "1", "2", "3", "4", "5", "6", "NoWait"	"NoWait"	-g LCK_cycle
"Wait for PLL Lock (Output Events)" <i>(V6/7 series only)</i>	list	"0", "1", "2", "3", "4", "5", "6", "NoWait"	"NoWait"	-g LCK_cycle
"Wakeup Clock" <i>(S3A/S6 only)</i>	list	"Startup Clock", "Internal Clock"	"Startup Clock"	-g Sw_clk
"Watchdog Timer Mode" <i>(V5/V6/7 series only)</i>	list	"Off", "Config", "User"	"Off"	
"Watchdog Timer Value" <i>(dependent)</i> <i>(S6/V5/V6/7 series only)</i>	string	hex string	0x000000 <i>(V5/V6/7 series);</i> 0xFFFF <i>(S6)</i>	-g TIMER_CFG

Process Properties - Generate Post-Place and Route Simulation Model Process

The following table of Generate Post-Place and Route Simulation Model (NetGen) Process Properties can be used with `project set` and `project get` with `-process "Generate Post-Place & Route Simulation Model"`.

Generate Post-Place and Route Simulation Model Process Properties

Note the values listed in this table are associated with NetGen processes when applied to Virtex®-5 devices. In a few cases, values may differ for other devices.

Note the "command-line equivalent" column is intended not as an explanation of the shell command-line syntax, but as a reference should you wish to refer to this equivalent argument elsewhere in this guide.

Property Name	Type	Allowed Values in Tcl	Default Value	NetGen Command-Line Equivalent
"Automatically Insert glbl Module in the Netlist"	boolean	TRUE, FALSE	TRUE	<code>-insert_glbl</code>
"Bring Out Global Set/Reset Net as a Port"	boolean	TRUE, FALSE	FALSE	<code>-gp</code>
"Bring Out Global Tristate Net as a Port"	boolean	TRUE, FALSE	FALSE	<code>-tp</code>
"Custom Compile File List"	filenames			<code>-hdl_compilation_order</code>
"Device Speed Grade/Select ABS Minimum"	list	-3, -2, -1, "Absolute Min"	-3	<code>-s</code>
"Generate Architecture Only (No Entity Declaration)"	boolean	TRUE, FALSE	FALSE	<code>-a</code>
"Do Not Escape Signal and Instance Names in Netlist"	boolean	FALSE, TRUE	FALSE	<code>-ne</code>
"Generate Multiple Hierarchical Netlist Files"	boolean	FALSE, TRUE	FALSE	<code>-insert_glbl</code>
"Global Set/Reset Port Name"	string		GSR_PORT	Use with <code>-gp</code>
"Global Tristate Port Name"	string		GTS_PORT	Use with <code>-tp</code>
"Include sdf_annotate task in Verilog File"	boolean	TRUE, FALSE	TRUE	<code>-sdf_anno</code>
"Include SIMPRIM Models in Verilog File"	boolean	FALSE, TRUE	FALSE	<code>-ism</code>

Property Name	Type	Allowed Values in Tcl	Default Value	NetGen Command-Line Equivalent
"Include 'uselib Directive in Verilog File"	boolean	FALSE, TRUE	FALSE	-ul
"Insert Buffers to Prevent Pulse Swallowing"	boolean	TRUE, FALSE	TRUE	-insert_pp_buffers
"Other NetGen Command Line Options"	text string	any legal command-line equivalent arguments that are not already set through other properties	none	none
"Output Extended Identifiers"	boolean	TRUE, FALSE	FALSE	-extid
"Rename Design Instance in Testbench File to"	text string		none	-ti
"Rename Top Level Architecture To"	text string		none	-ar
"Rename Top Level Entity to"	text string		none	-tm
"Rename Top Level Module To"	text string		none	-tm
"Reset On Configuration Pulse Width"	numeric	time in nanoseconds	0	-rpw
"Retain Hierarchy"	boolean	TRUE, FALSE	TRUE	-fn
"Simulation Model Target"	list	"Verilog", "VHDL"	"Verilog"	
"Tristate On Configuration Pulse Width"	numeric	time in nanoseconds	0	-tpw

Process Properties - Generate Post-Place and Route Static Timing Process

The following table of Generate Post-Place and Route Static Timing Process Properties can be used with `project set` and `project get` with `-process "Generate Post-Place & Route Static Timing"`.

Generate Post-Place and Route Static Timing Process Properties

Note the values listed in this table are associated with processes when applied to Virtex®-5 devices. In a few cases, values may differ for other devices.

Note the "command-line equivalent" column is intended not as an explanation of the shell command-line syntax, but as a reference should you wish to refer to this equivalent argument elsewhere in this guide.

Property Name	Type	Allowed Values in Tcl	Default Value	TRACE Command-Line Equivalent
"Change Device Speed To"	list	"-2", "-3", "-3N", "-4"		<code>-s</code>
"Generate Constraints Interaction Report"	boolean	FALSE, TRUE	FALSE	<code>-tsi</code>
"Generate Datasheet Section"	boolean	TRUE, FALSE	TRUE	<code>-nodatasheet</code>
"Generate Timegroups Section"	boolean	FALSE, TRUE	TRUE	<code>-timegroups</code>
"Number of Paths in Error/Verbose Report"	numeric	0 to 2 billion	3	
"Perform Advanced Analysis"	boolean	FALSE, TRUE	TRUE	<code>-a</code>
"Report Fastest Path(s) in Each Constraint"	boolean	TRUE, FALSE	TRUE	<code>-fastpaths</code>
"Report Paths by Endpoint"	numeric	0 to 2 billion	0 (no paths reported by endpoint)	<code>-n</code>
"Report Type"	list	"Verbose Report", "Error Report", "Summary Report"	"Verbose Report"	<code>-v -e</code>
"Report Unconstrained Paths"	numeric	0 to 2 billion	0 (no unconstrained paths reported)	<code>-u</code>
"Stamp Timing Model Filename"	string	Name of file to stamp	none	<code>-stamp</code>

Xilinx Tcl Commands for General Use

In most cases, the examples shown assume that a project has been created with the `project new` command or a project has been opened with the `project open` command. Project files are added with the `xfile add` command.

To view how Xilinx® Tcl commands can be used in a realistic way, see the [Example Tcl Scripts](#) located at the end of this chapter.

The following table summarizes the Xilinx Tcl commands for general use

Commands	Subcommands
<code>lib_vhdl</code> (manage VHDL libraries)	<code>add_file</code> <code>get</code> <code>delete</code> <code>new</code> <code>properties</code>
<code>process</code> (run and manage project processes)	<code>get</code> <code>properties</code> <code>run</code> <code>set</code>
<code>project</code> (create and manage projects)	<code>archive</code> <code>clean</code> <code>close</code> <code>get</code> <code>get_processes</code> <code>new</code> <code>open</code> <code>properties</code> <code>set</code>
<code>xfile</code> (manage project files)	<code>add</code> <code>get</code> <code>properties</code> <code>remove</code> <code>set</code>

lib_vhdl (manage VHDL libraries)

This command manages VHDL libraries within an ISE® project.

Use the `lib_vhdl` command to create, delete, add to VHDL libraries, and get information on any VHDL library in the current project.

Syntax

```
% lib_vhdl subcommand
```

Available subcommands are:

- `new` (create a new library)
- `delete` (delete a library)
- `add_file` (add a source file to a library)
- `properties` (get the list of library properties)
- `get` (get a library property value)

For More Information

For more information about a subcommand, type:

```
% help lib_vhdl subcommand
```

lib_vhdl add_file (add a source file to the library)

This command adds the source file from the current ISE® project to the existing library in the current project.

Syntax

```
% lib_vhdl add_file library_name file_name
```

`lib_vhdl` is the Tcl command name.

`add_file` is the subcommand name.

library_name specifies the name of the VHDL library.

file_name specifies the name of the project source file.

Example

```
% lib_vhdl add_file mylib top.vhd
```

This example adds the source file, `top.vhd`, to the `mylib` library.

Tcl Return

True if the file was added successfully; otherwise an ERROR message appears.

For More Information

```
% help lib_vhdl
```

lib_vhdl delete (delete a library)

This command deletes the specified library from the current ISE® project.

Syntax

```
% lib_vhdl delete library_name
```

`lib_vhdl` is the Tcl command name.

`delete` is the subcommand name.

library_name specifies the name of the library to delete.

Example

```
% lib_vhdl delete mylib
```

This example deletes the `mylib` library from the current project.

Tcl Return

True if the library was deleted successfully; otherwise an ERROR message appears.

For More Information

```
% help lib_vhdl
```

lib_vhdl get (get the library property value)

The `lib_vhdl get` command returns the value of the specified library property.

To get a list of all library properties, use [lib_vhdl properties](#) (get list of library properties).

Syntax

```
% lib_vhdl get library_name property_name
```

`lib_vhdl` is the Tcl command name.

`get` is the subcommand name.

library_name specifies the name of the library.

property_name specifies the name of the library property. Valid property names are name and files.

Example 1

```
% lib_vhdl get mylib name
```

This example returns the name of the mylib library.

Example 2

```
% lib_vhdl get mylib files
```

This example returns the list of files in the mylib library.

Tcl Return

The property value if successful; otherwise an ERROR message.

For More Information

```
% help lib\_vhdl
```

lib_vhdl new (create a new library)

This command creates a new library in the current ISE® project.

Syntax

```
% lib_vhdl new library_name
```

`lib_vhdl` is the Tcl command name.

`new` is the subcommand name.

library_name specifies the name of the library you wish to create.

Example

```
% lib_vhdl new mylib
```

This example creates a new VHDL library named mylib and adds it to the current project.

Tcl Return

True if the library was created successfully; otherwise ERROR message appears.

For More Information

```
% help lib\_vhdl
```

lib_vhdl properties (get list of library properties)

This command returns a list of all library properties.

To see the value of a specific library property, use `lib_vhdl get` ([get the library property value](#)).

Syntax

```
% lib_vhdl properties
```

`lib_vhdl` is the Tcl command name.
`properties` is the subcommand name.

Example

```
% lib_vhdl properties
```

This example returns a list of library properties.

Tcl Return

A list of properties if successful; otherwise an ERROR message.

For More Information

```
% help lib_vhdl
```

process (run and manage project processes)

This command runs and manages all processes within the current ISE® project.

Syntax

```
% process subcommand
```

Available subcommands are:

- `get` (get the value of the specified property for a process)
- `properties` (list process properties)
- `run` (run process task)
- `set` (set the value of the specified property on a process)

For More Information

For more information about a subcommand, type:

```
% help process subcommand
```

process get (get the value of the specified property for a process)

This command gets the status of the specified process task.

Note The list of available processes changes based on the source file you select. Use the `% project get_processes` command to get a list of available processes. Type `% help project get_processes` for more information.

Syntax

```
% process get process_task property_name
```

`process` is the Tcl command name.

`get` is the subcommand name.

`process_task` specifies the name of one of the process tasks for which to get the property. Process tasks are listed in the Processes pane of the Design panel in Project Navigator. The list of available processes changes based on the source file you select. Use the `% project get_processes` command to get a list of available processes. Type `% help project get_processes` for more information.

`property_name` is the name of the property. Valid properties for this command are "status" and "name."

Example 1

```
% process get "Map" status
```

This example gets the current status of the Map process.

Example 2

```
% process get "place" name
```

This example gets the full name of the process that starts with the string "place". The returned value will be "Place & Route".

Tcl Return

The value of the specified property as a text string.

For More Information

```
% help process
```

process properties (list process properties)

This command lists the process properties. Two properties are supported for this command:

- The "name" property is used to print the ISE® process name.
- The "status" property is used to manage the status information on the process.

Syntax

```
% process properties
```

process is the Tcl command name.

properties is the subcommand name.

Example

```
% process properties
```

This example lists all process properties.

Tcl Return

The available process properties as a Tcl list.

For More Information

```
% help process
```

process run (run process task)

This command runs the specified process task in the current ISE® project.

Note The list of available processes changes based on the source file you select. Use the % [project get_processes](#) command to get a list of available processes. Type % [help project get_processes](#) for more information.

Syntax

```
% process run process_task [-instance instance_name] [-force { rerun | rerun_all }]
```

process is the Tcl command name.

run is the subcommand name.

process_task specifies the name of the process task to run. Process tasks are listed in the Project Navigator Process pane.

-instance is the option to limit the search for processes to the specified *instance_name*.

instance_name specifies the name of the instance to limit search of the *process_task* for. The default is the top-level instance.

-force is the option to force the re-implementation of the specified process regardless of the current state of the process.

rerun reruns the processes and updates input data as necessary, by running any dependent processes that are out-of-date.

rerun_all reruns the processes and all dependent processes back to the source data, as defined by the specified process goal. All processes are run whether they are out of date or not.

Note Process run will return true if it was able to launch the process regardless of the process result. To determine the specific process run results, use the process get command.

Example 1

```
% process run "Translate"
```

This example runs the "Translate" process.

Example 2

```
% process run "Implement Design" -force rerun_all
% set my_status [ process get "Implement Design" status ]
```

The first command forces the re-implementation of the entire design, regardless of whether all source files are up-to-date or not. The second command sets 'my_status' to a string value representing the end status of the process. Possible status values are: never_run, up_to_date, warnings, errors, aborted, out_of_date, and running.

Tcl Return

True if the process was successfully launched; false otherwise.

For More Information

```
% help process
```

process set (set the value of the specified property on a process)

The process set command is used to set the property value for the specified process.

Note The list of available processes changes based on the source file you select. Use the `% project get_processes` command to get a list of available processes. Type `% help project get_processes` for more information.

Syntax

```
% process set process_task property_name property_value
```

process is the Tcl command name.

set is the subcommand name.

process_task specifies the name of one of the process tasks on which the property needs to be set. Process tasks are listed in the Process window in Project Navigator.

property_name is the name of the property. Currently, the only property supported for this command is "status".

property_value specifies the name of the property value. The list of property values are: "up_to_date"

Example

```
% process set "Map" status up_to_date
```

This example forces the up_to_date status on the Map process. If the MAP process was out_of_date for some reason, this command will force the MAP process to be up_to_date and in ISE® Project Navigator, a green tick will be displayed by the process name.

Tcl Return

The value of the property set as a text string.

For More Information

```
% help process
```

project (create and manage projects)

This command creates and manages ISE® projects. A project contains all files and data related to a design. You can create a project to manage all of the design files and to enable different processes to work on the design.

Syntax

```
% project subcommand
```

Available subcommands are:

- [archive](#) (archive all files belonging to the current ISE project)
- [clean](#) (remove system-generated project files)
- [close](#) (close the ISE project)
- [get](#) (get project properties)
- [get_processes](#) (get project processes)
- [new](#) (create a new ISE project)
- [open](#) (open an ISE project)
- [properties](#) (list project properties)
- [set](#) (set project properties, values, and options)

For More Information

For more information about a subcommand, type:

```
% help project subcommand
```

project archive (archive all project files)

The project archive command archives all of the files in the current ISE® project, including temporary, system-generated, and HDL source files. Note that if some of these files, typically HDL source files, are from remote directories and were not copied to the current project directory with the `xfile add -copy` command, then these files will not be automatically copied to their original directories once the archive is restored. Manually copying these files to the remote locations is necessary.

Syntax

```
% project archive archive_name
```

project is the Tcl command name.

archive is the subcommand name.

archive_name is the name of the archive that all files will be saved to. Typically, the archive file has a .zip extension. If no extension is specified, .zip is assumed.

Caution! If the specified archive name already exists, the existing archive is overwritten.

Example

```
% project archive myarchive.zip
```

This example archives all files in the current project. The name of the archive is myarchive.zip.

Tcl Return

True if the project is archived successfully; false otherwise.

For More Information

```
% help project
```

project clean (remove system-generated project files)

The project clean command removes all of the temporary and system-generated files in the current ISE® project. It does not remove any source files, like Verilog or VHDL, nor does it remove any user-modified files. For example, system-generated design and report files like the NCD (.ncd) and map report (.mpr) are removed with the project clean command, unless they have been user-modified.

Syntax

```
% project clean
```

project is the Tcl command name.

clean is the subcommand name.

Caution! The project clean command permanently deletes all system-generated files from the current project. These files include the NGD, NGA, and NCD files generated by the implementation tools.

Example

```
% project clean
```

This example cleans the current project. All temporary and system-generated files are removed.

Tcl Return

True if the project is cleaned successfully; false otherwise.

For More Information

```
% help project
```

project close (close the ISE project)

The project close command closes the current ISE® project.

Syntax

```
% project close
```

project is the Tcl command name.

close is the subcommand name.

Example

```
% project close
```

This example closes the current project.

Tcl Return

True if the project is closed successfully; false otherwise.

For More Information

```
% help project
```

project get (get project properties)

The project get command returns the value of the specified project-level property or batch application option.

Syntax

```
% project get {option_name/property_name} [-process  
process_name] [-instance instance_name ]
```

project is the Tcl command name.

get is the subcommand name.

option_name specifies the name of the batch application option you wish to get the value of, such as Map Effort Level. Batch application options are entered as strings distinguished by double quotes (""). You can specify either the exact text representation of the option in Project Navigator, or a portion. If only a portion, this command attempts to complete *option_name* or lists an error message if a unique *option_name* is not found.

property_name specifies the name of the property you wish to get the value of. Valid property names are family, device, generated_simulation_language, package, speed, and top.

-process is the command that limits the properties listed to only those for the specified process. By default, the properties for all synthesis and implementation processes are listed. You can also specify "all" to list the properties for all project processes.

process_name specifies the name of the process for which the value of *option_name* is to be obtained.

-instance is the command to limit the search for the *option_name* to the specified *instance_name*.

instance_name specifies the name of the instance to look for the *option_name*. This is only needed if you want to limit search of the *option_name* to processes applicable to *instance_name*, which may only be part of the design. It is necessary to specify the full hierarchical instance name; the default is the top-level instance.

Example

```
% project get speed
```

This example gets the value of the speed grade that was set with the "project set speed" command.

Tcl Return

The property value as a text string.

For More Information

`% help project`

project get_processes (get project processes)

The project get_processes command lists the available processes for the specified instance.

Syntax

```
% project get_processes [-instance instance_name ]
```

`project` is the Tcl command name.

`get_processes` is the subcommand name.

`-instance` limits the properties listed to only those of the specified instance. If no instance is specified, the top-level instance is used by default.

`instance_name` specifies the name of the instance you wish to know the available processes for.

Example

```
% project get_processes -instance /stopwatch/Inst_dcm1
```

This example lists all of the available processes for only the instance /stopwatch/Inst_dcm1.

Tcl Return

The available processes as a Tcl list.

For More Information

`% help project`

project new (create a new ISE project)

The project new command creates a new ISE® project.

Syntax

```
% project new project_name
```

`project` is the Tcl command name.

`new` is the subcommand name.

`project_name` specifies the name for the project you wish to create. If an `.ise` extension is not specified, it is assumed.

Example

```
% project new watchver.ise
```

This example creates a new project named watchver.ise.

Tcl Return

The name of the new project.

For More Information

`% help project`

project open (open an ISE project)

The project open command opens an existing ISE® project. If the project does not exist, an error message to create a new project with the project new command appears. If an attempt to open an already opened project is made, the current project is closed and the specified project becomes the current project.

Syntax

```
% project open project_name
```

project is the Tcl command name.

open is the subcommand name.

project_name specifies the name for the project you wish to open. If a .ise extension is not specified, it is assumed.

Example

```
% project open watchver.ise
```

This example opens the watchver.ise project in the current directory.

Tcl Return

The name of the open project.

For More Information

% [help project](#)

project properties (list project properties)

The project properties command lists all of the project properties for the specified process or instance.

Syntax

```
% project properties [-process process_name] [-instance  
instance_name]
```

project is the Tcl command name.

properties is the subcommand name.

-process *process_name* limits the properties listed to only those for the specified process. By default, all properties known to the system are listed.

-instance *instance_name* limits the properties listed to only those of the specified instance. If no instance name is specified, the properties for the top-level instance are listed. You can also specify "top" to specify the top-level instance. Otherwise, it is necessary to specify the full hierarchical instance name.

Note To get processes information for a specific instance, use the % [project get processes](#) command. To get property information for specific properties such as family, device, and speed, use the % [project get](#) command.

Example

```
% project properties -process Map
```

This example lists the properties available for the Map process in the current project.

Tcl Return

The available properties for the specified process as a Tcl list.

For More Information

`% help project`

project set (set project properties, values, and options)

This command is used to set properties and values for the current ISE® project. For specific project properties that you can set with this command, see [Project Properties](#) earlier in this chapter.

In addition to setting family and device-specific properties and values, this command is also used to set options for the batch application tools, including XST (see [Process Properties - Synthesize Process](#)), NetGen (see [Process Properties - Generate Post-Place and Route Simulation Model Process](#)), NGDBuild (see [Process Properties - Translate Process](#)), MAP (see [Process Properties - MAP Process](#)), PAR (see [Process Properties - Place and Route Process](#)), TRACE, and BitGen (see [Process Properties - Generate Programming File Process](#)). The **set** subcommand uses two required arguments. The first argument assigns the name of the property or variable; and the second argument assigns the value. The optional **-process** and **-instance** arguments limit the property setting to the specified process and/or instance.

Syntax

```
% project set property_name property_value [-process
process_name] [-instance instance_name]
```

project is the Tcl command name.

set is the subcommand name.

property_name specifies the name of the property, variable or batch application option.

property_value specifies the value of the property, variable, or batch application option.

-process *process_name* limits the property search to only those for the specified process. By default, the properties for all synthesis and implementation processes are listed. You can also specify **-process all** to list the properties for all project processes.

-instance *instance_name* limits the property search to only those of the specified instance. If no instance name is specified, the properties for the top-level instance are listed. You can also specify **-instance top** to specify the top-level instance. You must specify the full hierarchical name of the instance.

Note Some batch application options only work when other options are specified. For example, in XST, the Synthesize Constraints File option only works if the Use Synthesis Constraints File option is also specified. Batch application options are entered as strings distinguished by double quotes (""). You can specify either the exact text representation of the option in Project Navigator, or a portion. If a portion, this command attempts to complete the *option_name* or lists an error message if a unique *option_name* is not found.

Note For VHDL based sources, the top level source is set using the *architecture_name* *entity_name*. See the example below.

Example 1

```
% project set top /stopwatch/sixty
```

This example sets the top level source to the instance named "sixty"

Example 2

```
% project set top inside cnt60
```

This example sets the top level source to the instance corresponding to the architecture named "inside" and entity named "cnt60"

Example 3

```
% project set "Map Effort Level" High
```

This example sets the map effort level to high.

Tcl Return

The value of the newly set option.

For More Information

```
% help project
```

xfile (Manage ISE Source Files)

This command is used to manage all of the source files within an ISE® project. Use this command to add, remove, and get information on any source files in the current project.

Syntax

```
% xfile subcommand
```

Available subcommands are:

- **add** (add files to project)
- **get** (get project file properties)
- **properties** (list file properties)
- **remove** (remove files from project)
- **set** (set the value of the specified property for file)

For More Information

For more information about a subcommand, type:

```
% help xfile subcommand
```

xfile add (add files to project)

This command adds the specified files to the current ISE® project. If you use the **-copy** argument, files are first copied to the current project directory and then added to the project. Files can be added to a project in any order; wildcards may be used.

You can also add files to the VHDL libraries using this command.

The default association of a file is "All" views. This association can be changed by using the **-view** option.

Syntax

```
% xfile add file_name [-copy] [-lib_vhdl library_name] [-view view_type] [-include_global]
```

xfile is the Tcl command name.

add is the subcommand name.

file_name specifies the name of the source file(s) you wish to add to the current project. Wildcards can be used to specify one or more files to add to the project. Tcl commands support wildcard characters, such as "*" and "?". Please consult a Tcl manual for more information on wildcards.

-copy is the optional argument for copying files to the current project.

-lib_vhdl specifies the option to add the file(s) to an existing VHDL library.

library_name is the name of the VHDL library.

-view specifies the option to set the view-type for the source file.

view_type specifies the name of the view-type. Values are: "All" "Implementation" "Simulation" "None".

-include_global tells xfile to increment the compile order sequence ID for each of the sources added to the project.

Example 1

```
% xfile add alu.vhd processor.vhd alu.ucf
```

This example adds the `alu.vhd`, `processor.vhd` and `alu.ucf` files to the current project.

Example 2

```
% xfile add *.v
```

This example adds all of the Verilog files from the current directory to the current project.

Example 3

```
% xfile add test.vhd -lib_vhdl mylib
```

This example adds the `test.vhd` source file to the current project. The command also adds this file to the "mylib" library.

Example 4

```
% xfile add test_tb.vhd -view "Simulation"
```

This example adds the `test_tb.vhd` source file to the simulation view ONLY in the current project.

Tcl Return

True if the file was added successfully; otherwise false.

For More Information

```
% help xfile
```

xfile get (get project file properties)

This command returns information on the specified project file and its properties. There are two properties supported for this command: name and timestamp

Syntax

```
% xfile get file_name {name|timestamp|include_global}
```

xfile is the Tcl command name.

get is the subcommand name.

file_name specifies the name of the source file to get the name or timestamp information on.

name if specified, returns the full path of the specified file.

timestamp if specified, returns the timestamp of when the file was first added to the project with the `xfile add` command.

include_global if specified returns the status of the compile order tag (true if the file is part of the compile order list and false if it is not).

Example

```
% xfile get stopwatch.vhd timestamp
```

This example gets the timestamp information for the stopwatch.vhd file.

Tcl Return

The value of the specified property as a text string.

For More Information

```
% help xfile
```

xfile properties (list file properties)

This command lists all of the available file properties. There are two properties supported for this command: name and timestamp

Syntax

```
% xfile properties
```

xfile is the Tcl command name.

properties is the subcommand name.

Note To get a list of all files in the project, use the search command

Example

```
% xfile properties
```

This example lists the available properties of files in the current project.

Tcl Return

The available file properties as a Tcl list.

For More Information

For more information, type:

- % help xfile
- % help search

xfile remove (remove files from project)

This command removes the specified files from the current ISE® project.

Note The files are not deleted from the physical location (disk).

Syntax

```
% xfile remove file_name
```

xfile is the Tcl command name.

remove is the subcommand name.

file_name specifies the names of the files you wish to remove from the project. Wild cards are not supported (use a Tcl list instead as shown in Example 3 below).

Example 1

```
% xfile remove stopwatch.vhd
```

This example removes `stopwatch.vhd` from the current project.

Example 2

```
% xfile remove alu.vhd processor.vhd
```

This example removes `alu.vhd` and `processor.vhd` from the current project.

Example 3

```
% xfile remove [ search *memory*.vhd -type file ]
```

This example removes all VHDL files with "memory" in the file name from the current project.

- The command in brackets uses wildcards to create a Tcl list of file names containing "memory."
- The list is then used to remove these files from the project.

Example 4

```
% set file_list [ list alu.v processor.v ]
```

```
% xfile remove $file_list
```

This example removes `alu.v` and `processor.v` from the current project.

- The first command creates a Tcl list named `file_list` containing the files `alu.v` and `processor.v`.
- The second command removes the files in the list from the project.

Tcl Return

true if the file(s) were removed successfully; false otherwise.

For More Information

```
% help xfile
```

xfile set (set the value of the specified property for file)

This command sets property values for the specified file within the current ISE® project.

The only property supported for this command is "lib_vhdl"

Syntax

```
% xfile set file_name property_name property_value
```

xfile is the Tcl command name.

set is the subcommand name.

file_name specifies the name of the source file for which the property needs to be set.

property_name specifies the name of the property.

property_value specifies the value of the property.

Example 1

```
% xfile set stopwatch.vhd lib_vhdl mylib
```

This example sets the `lib_vhdl` information for the `stopwatch.vhd` file and adds it to the "mylib" library.

Example 2

```
% xfile set stopwatch.vhd include_global true
```

This example adds stopwatch.vhd to the compile order list. To remove a file from the list, use `include_global false`

Tcl Return

The new value of the specified property as a text string.

For More Information

```
% help xfile
```

Xilinx Tcl Commands for Advanced Scripting

Xilinx® Tcl commands for advanced scripting use objects and collections. An object can be any element in an ISE® project, like an instance, file, or process. Collections return groups of objects, based on values that you assign to object and collection variables.

In most cases, the examples shown assume that a project has been created with the **project new** command or a project has been opened with the **project open** command. Project files are added with the **xfile add** command.

The following table summarizes the Xilinx Tcl commands for advanced scripting.

Commands	Subcommands
globals (manipulate Xilinx global data)	get properties set unset
collection (create and manage a collection)	append_to copy equal foreach get index properties remove_from set sizeof
object (get object information)	get name properties type
search (search for matching design objects)	

globals (manipulate Xilinx global data)

This command manipulates Xilinx® global data.

Syntax

```
% globals subcommand
```

Available subcommands are:

- **get** (get global property/data)
- **set** (set global property/data)
- **properties** (list global properties/data)
- **unset** (unset global property/data)

For More Information

For more information about a subcommand, type:

```
% help globals subcommand
```

globals get (get global properties/data)

This command returns the value of the specified global property.

Syntax

```
% globals get property_name
```

globals is the Tcl command name.

get is the subcommand name.

property_name specifies the name of one of the global properties/data.

Example

```
% globals get display_type
```

This example returns the value of global property 'display_type'.

Tcl Return

The value of the specified property.

For More Information

```
% help globals
```

globals properties (list global properties)

This command lists the available global properties.

Syntax

```
% globals properties
```

globals is the Tcl command name.

properties is the subcommand name.

Example

```
% globals properties
```

This example returns the list of available global properties.

Tcl Return

The available globals properties as a Tcl list.

For More Information

```
% help globals
```

globals set (set global properties/data)

This command sets the value of the specified global property. If the property does not exist, it is created.

Syntax

```
% globals set property_name property_value
```

globals is the Tcl command name.

set is the subcommand name.

property_name specifies the name of one of the global properties/data.

property_value specifies the value for property.

Example

```
% globals set display_type 1
```

This example sets the value of global property 'display_type' to 1.

Tcl Return

The value of the specified property.

For More Information

```
% help globals
```

globals unset (unset global properties/data)

This command deletes the specified global property.

Syntax

```
% globals unset property_name
```

globals is the Tcl command name.

unset is the subcommand name.

property_name specifies the name of one of the global properties/data.

Example

```
% globals unset display_type
```

This example deletes the global property 'display_type'.

Tcl Return

The value of the specified property.

For More Information

```
% help globals
```

collection (create and manage a collection)

A collection is a group of Tcl objects, similar to a list, which is exported to the Tcl interface. This command lets you create and manage the objects in a specified collection.

A collection is referenced in Tcl by a collection variable, which is defined with the set command. Technically, the value of the collection variable is the collection.

Syntax

```
% collection subcommand
```

Available subcommands are:

- `append_to` (add objects to a collection)
- `copy` (copy a collection)
- `equal` (compare two collections)
- `foreach` (iterate over elements in a collection)
- `get` (get collection property)
- `index` (extract the object)
- `properties` (list available collection properties)
- `remove_from` (remove objects from a collection)
- `set` (set a collection property)
- `sizeof` (show the number of objects in a collection)

For More Information

For more information about a subcommand, type:

```
% help collection subcommand
```

collection append_to (add objects to a collection)

This command adds objects to a collection. It treats a specified collection variable as a collection and appends all of the objects returned from a search, or from another collection, to the collection. If the collection variable does not exist, then it is created when the command is executed.

Syntax

```
% collection append_to collection_variable objects_to_append  
[-unique]
```

`collection` is the Tcl command name.

`append_to` is the subcommand name.

`collection_variable` specifies the name of the collection variable, which references the collection. If the collection variable does not exist, then it is created.

`objects_to_append` specifies an object or a collection of objects to be added to the collection.

`-unique` optionally adds only objects that are not already in the collection. If the `-unique` option is not used, then duplicate objects may be added to the collection.

Example

```
% collection append_to colVar [search * -type instance]
```

This example creates a new collection variable named `colVar`. The nested search command returns a collection of all the instances in the current design. These instances are objects that are added to the collection, referenced by the `colVar` collection variable.

Tcl Return

A collection of objects.

For More Information

- `% help collection`
- `% help object`
- `% help search`

collection copy (copy a collection)

This command creates a duplicate of an existing collection. It should be used only when two separate copies of a collection are needed. Example 1 shows how to create a copy of a collection.

Alternatively, rather than copying the collection you can just have more than one collection variable referencing the collection. In most cases, a second reference to a collection is all that is needed, and ensures that the variables always reference the same items. Example 2 shows how to reference a single collection from two variables.

Syntax

```
collection copy collection_variable
```

collection is the Tcl command name.

copy is the subcommand name.

collection_variable specifies the name of the collection to copy.

Example 1 — Create a Separate Collection

```
% set colVar_2 [collection copy $colVar_1]
```

This example creates the collection variable `colVar_2`. The nested `collection copy` command makes a duplicate of the `colVar_1` collection and assigns it to the `colVar_2` collection variable, making it a completely separate collection.

Example 2 — Two References to One Collection

```
% set colVar_1 [search * -type instance]
```

```
% set colVar_2 $colVar_1
```

This example creates a collection (`colVar_2`) that references another collection (`colVar_1`).

- The first command creates a collection assigned to the collection variable `colVar_1`.
- The second command creates a second collection variable, `colVar_2`, that references the value of `colVar_1`.

Note There is still only one underlying collection referenced. Any changes made to `colVar_1` or `colVar_2` will be visible in both collection variables.

Tcl Return

A new collection.

For More Information

- `% help collection`
- `% help object`
- `% help search`

collection equal (compare two collections)

This command compares the contents of two collections. Collections are considered equal when the objects in both collections are the same. If the same objects are in both collections, the result is 1. If the objects in the compared collections are different, then the result is 0. By default, the order of the objects does not matter. Optionally, the `order_dependent` option can be specified for the order of the objects to be considered.

Syntax

```
% collection equal colVar_1 colVar_2 [-order_dependent]
```

collection is the Tcl command name.

equal is the name of the collection sub command.

colVar_1 specifies the base collection for the comparison.

colVar_2 specifies the collection to compare with the base collection.

-order_dependent optionally specifies that the collections are considered different when the order of the objects in both collections are not the same.

Note When two empty collections are compared, they are considered identical and the result is 1.

Example

```
% set colVar_1 [search * -type instance]
% set colVar_2 [search /top/T* -type instance]
% collection equal $colVar_1 $colVar_2
```

This example compares the contents of two collections.

- The first command assign a collection of instances to the collection variable *colVar_1*.
- The second command assigns another collection of filtered instance names to the collection variable *colVar_2*.
- The third command compares the two collections. The dollar sign (\$) syntax is used to obtain the values of the collection variables. In this case, the values of *colVar_1* and *colVar_2* to determine if they are equal.

Tcl Return

0 if the collections are not the same, 1 if the collections are the same.

For More Information

- [% help collection](#)
- [% help object](#)
- [% help search](#)

collection foreach (iterate over elements in a collection)

This command iterates over each object in a collection through an iterator variable. The iterator variable specifies the collection to iterate over and the body specifies the set of commands or script to apply at each iteration.

Syntax

```
% collection foreach iterator_variable collection_variable
{body}
```

collection is the Tcl command name.

foreach is the subcommand name.

iterator_variable specifies the name of the iterator variable.

collection_variable specifies the name of the collection to iterate through.

body specifies a set of commands or script to execute at each iteration.

Caution! You cannot use the standard Tcl-supplied `foreach` command to iterate over collections. You must use the Xilinx®-specific `collection foreach` command. Using the Tcl-supplied `foreach` command may cause the collection to be deleted.

Example

```
% set colVar [search * -type instance]
% collection foreach itr $colVar {puts [object name $itr]}
```

This example iterates through the objects of a collection.

- The first command assigns a collection of instances to the colVar collection variable.
- The second line iterates through each object in the colVar collection, where *itr* is the name of the iterator variable. Curly braces { } enclose the body, which is the script that executes at each iteration. Note that the object name command is nested in the body to return the value of the iterator variable, which is an instance in this case.

Tcl Return

An integer representing the number of times the script was executed

For More Information

- [% help collection](#)
- [% help object](#)
- [% help search](#)

collection get (get collection property)

This command returns the value of the specified collection property. Collection properties and values are assigned with the collection set command.

Syntax

```
% collection get property_name
```

collection is the Tcl command name.

get is the subcommand name.

property_name specifies the name of the property you wish to get the value of. Valid property names for the collection get command are `display_line_limit` and `display_type`.

Note See also the collection set command.

Example

```
% collection get display_type
```

This example gets the current setting of the `display_type` property.

Tcl Return

The set value of the specified property.

For More Information

- [% help collection](#)
- [% help object](#)
- [% help search](#)

collection index (extract a collection object)

Given a collection and an index into it, this command extracts the object at the specified index and returns the object, if the index is in range. The base collection is unchanged.

The range for an index is zero (0) to one less (-1) the size of the collection obtained with the collection `sizeof` command.

Syntax

```
% collection index collection_variable index_value
```

collection is the Tcl command name.

index is the subcommand name.

collection_variable specifies the collection to be used for index.

index_value specifies the index into the collection. Index values are 0 to one minus the size of the collection. Use the collection sizeof command to determine the size of the collection.

Note Xilinx®-specific Tcl commands that create a collection of objects do not impose a specific order on the collection, but they do generate the objects in the same, predictable order each time. Applications that support sorting collections, can impose a specific order on a collection.

Example

```
% set colVar [search * -type instance]  
% set item [collection index $colVar 2]  
% object name $item
```

This example extracts the third object in the collection of instances.

- The first command creates a collection variable named colVar. The nested search command defines the value of the collection for colVar, which in this case is all of the instances in the current design.
- The second command creates a variable named item. The nested collection index command obtains the third object (starting with index 0, 1, 2 . . .) in the given collection.
- The last command returns the value of the item variable, which is the specified value of index.

Tcl Return

The object at the specified index.

For More Information

- [% help collection](#)
- [% help object](#)
- [% help search](#)

collection properties (list available collection properties)

The collection properties command displays a list of the supported properties for all collections in the current ISE® project. You can set the value of any property with the collection set command.

Syntax

```
% collection properties
```

collection is the Tcl command name.

properties is the subcommand name.

There are two collection properties: display_line_limit and display_type. These properties are supported with the collection get and collection set commands.

Note See the collection get command for a list of available properties.

Example

```
% collection properties
```

This example displays a list of available collection properties. It returns `display_line_limit` and `display_type`.

Tcl Return

A list of available collection properties.

For More Information

- [% help collection](#)
- [% help object](#)
- [% help search](#)

collection remove_from (remove objects from a collection)

This command removes objects from a specified collection, modifying the collection in place. If you do not wish to modify the existing collection, first use the `collection copy` command to create a duplicate of the collection.

Syntax

```
% collection remove_from collection_variable objects_to_remove
```

`collection` is the Tcl command name.

`remove_from` is the subcommand name.

`collection_variable` specifies the name of the collection variable.

`objects_to_remove` specifies a collection of objects, or the name of an object that you wish to remove from the collection.

Example

```
% set colVar_1 [search * -type instance]
```

```
% set colVar_2 [search /stopwatch/s* -type instance]
```

```
% set colVar_3 [collection remove_from colVar_1 $colVar_2]
```

In this example, the objects in `colVar_2` are removed from `colVar_1`.

- The first command creates the collection variable `colVar_1`.
- The second command creates the collection variable `colVar_2`.
- The last command creates a third collection variable, `colVar_3` that contains all of the instances in `colVar_1`, but no instances in `colVar_2`.

Tcl Return

The original collection modified by removed elements.

For More Information

- [% help collection](#)
- [% help object](#)
- [% help search](#)

collection set (set the property for all collections)

This command sets the specified property for all collection variables in the current ISE® project.

Syntax

```
% collection set property_name property_value
```

collection is the Tcl command name.

set is the subcommand name.

property_name is the property name for all of the collection variables in the current project.

property_value is the property value for all of the collection variables in the current project.

There are two available property settings for the collection set command

- **display_line_limit** - specifies the number of lines that can be displayed by a collection variable. This property setting is useful for very large collections, which may have thousands, if not millions of objects. The default value for this property is 100. The minimum value is 0. There is no maximum value limit for this property.
- **display_type** - instructs Tcl to include the object type in the display of objects from any specified collection variable. Values for this property are true and false. By default, this option is set to false, which means object types are not displayed. See the example below.

Example

```
% collection set display_type true
```

This example sets the property name and value for all collection variables in the project, where `display_type` is the name of the property setting and `true` is the value for the property.

Tcl Return

The value of the property.

For More Information

- [% help collection](#)
- [% help object](#)
- [% help search](#)

collection sizeof (show the number of objects in a collection)

This command returns the number of objects in the specified collection.

Syntax

```
% collection sizeof collection_variable
```

collection is the Tcl command name.

sizeof is the subcommand name.

collection_variable specifies the name of the collection for Tcl to return the size of.

Example

```
% collection sizeof $colVar
```

This example returns the size of the collection, which is referenced by the `colVar` collection variable.

Tcl Return

An integer representing the number of items in the specified collection.

For More Information

- `% help collection`
- `% help object`
- `% help search`

object (get object information)

This command returns the name, type, or property information of any Xilinx® Tcl object in the current ISE® project.

You can specify a single object or an object from a collection of objects.

Syntax

```
% object subcommand
```

Available subcommands are:

- `get` (get object properties)
- `name` (name of the object)
- `properties` (list object properties)
- `type` (type of object)

For More Information

For more information about a subcommand, type:

```
% help object subcommand
```

object get (get object properties)

The command returns the value of the specified property.

Syntax

```
% object get obj property_name
```

`object` is the Tcl command name.

`get` is the subcommand name.

`obj` specifies the object to get the property of.

`property_name` specifies the name of one of the properties of an object.

The properties of an object vary depending on the type of object. Use the `object properties` command to get a list of valid properties for a specific object.

Example

```
% set colVar [search * -type instance]
% collection foreach obj $colVar {
  set objProps [object properties $obj]
  foreach prop $objProps {
    puts [object get $obj $prop]
  }
}
```

This example first runs a search to create a collection of all instances in the project. The second statement iterates through the objects in the collection. For each object, the list of available properties on the object are obtained by the object properties command. Then, the value of each property for each of the objects is returned.

Tcl Return

The value of the specified property.

For More Information

- [% help object](#)
- [% help collection](#)
- [% help search](#)

object name (returns name of the object)

This command returns the name of any Xilinx® object.

Syntax

```
% object name obj
```

object is the Tcl command name.

name is the subcommand name.

obj object whose name is to be returned.

Example

```
% set colVar [search * -type instance]
% object name [collection index $colVar 1]
```

This example returns the name of the second object in the colVar collection.

- The first command creates the colVar collection variable. The nested search command defines the value of the collection variable to be all instances in the current project.
- The second command gets the name of the second object in the collection. The collection index command defines which object to get, where \$colVar is the collection from which to get the object. One (1) specifies the index into the collection. Since index values start at 0 (zero), this returns the name of the second object in the collection.

Note See the collection index command for more information.

Tcl Return

The name of the object as a text string.

For More Information

- [% help object](#)
- [% help collection](#)
- [% help search](#)

object properties (list object properties)

The object properties command lists the available properties for the specified object.

Syntax

```
% object properties obj [-descriptors]
```

object is the Tcl command name.

properties is the subcommand name.

obj specifies the object to list the properties of.

-descriptors specifies that the command should return a collection of property descriptors on which users can iterate through to get more information on each property. If not specified, the command returns a list of property names as a TCL List.

Example 1

```
% set colVar [search * -type partition]
% collection foreach obj $colVar {
    set objProps [object properties $obj]
    foreach prop $objProps
        puts [object get $obj $prop]
    }
}
```

This example first runs a search to create a collection of objects. The second statement iterates through the objects in the collection. For each object, a list of available properties for the object are obtained with the object properties command. Then, the value of each property is returned for each object.

Example 2

```
% set colVar [search * -type partition]
% set partition [collection index $colVar 1]
% set propertyDescriptors [object properties $partition -descriptors]
% collection foreach propDescr $propertyDescriptors {
    puts "name           : [object get $propDescr name]"
    puts "type           : [object get $propDescr type]"
    puts "is_read_only      : [object get $propDescr is_read_only]"
    puts "allowable_values  : [object get $propDescr allowable_values]"
    puts "default          : [object get $propDescr default]"
    puts "units            : [object get $propDescr units]"
    puts "drivers           : [object get $propDescr drivers]"
    puts "description       : [object get $propDescr description]"
}
```

This example returns a collection of property descriptors. Property descriptors are objects which describe about a property, using properties.

You can iterate through these property descriptors to get more information about the property it is describing.

The following information can be retrieved from a property descriptor:

- The name of a property by specifying property 'name'.
- The property type by specifying property 'type'
- Find if a property is read only by specifying property 'is_read_only'
- The possible values of a property by specifying property 'allowable_values'
- The default value of a property by specifying property 'default'
- The units specification of a property by specifying property 'units'
- A list of property names on which this property depends by specifying property 'drives'
- A description of a property by specifying property 'description'

Tcl Return

Collection of property descriptors if `-descriptors` switch is specified, otherwise is returns a Tcl list of property names.

For More Information

- `% help object`
- `% help collection`
- `% help search`

object type (returns the type of object)

This command returns the type of any Xilinx® object.

Syntax

```
% object type obj
```

`object` is the Tcl command name.

`type` is the subcommand name.

`obj` specifies the object to return the type of. The object name will always be a Tcl variable. The set command is used to create a Tcl variable, as shown in the following example.

Example

```
% set colVar [search * -type instance]
```

```
% object type [collection index $colVar 1]
```

This example returns the object type of the second object in the collection.

- The first command creates the `colVar` collection variable. The nested search command defines the value of the collection variable to be all instances in the current project.
- The second command gets the name of the second object in the collection. The collection index command defines which object to get, where `$colVar` is the collection from which to get the object. One (1) specifies the index into the collection. Since index values start at 0 (zero), this returns the type of the second object in the collection.

Note See the collection index command for more information.

Tcl Return

The object type as a text string.

For More Information

- `% help object`
- `% help collection`
- `% help search`

search (search for matching design objects)

This command is used to search for specific design objects that match a specified pattern.

Syntax

```
% search {pattern|expression} [[-matchcase] [-exactmatch]
[-regexp]] | [-exp] [-type object_type] [-in
{project|collection}]
```

search is the Tcl command name.

pattern or *expression* is a string. When **-exp** is used, it is an *expression* that specifies the searching criteria using Xilinx® search expression syntax. When **-exp** is not used, it is a *pattern* that is used to match object names.

-matchcase is meaningful only when **-exp** is not used. It specifies that the names of the objects to be searched for should match *pattern* in a case-sensitive way.

-exactmatch is meaningful only when **-exp** is not used. It specifies that the names of the objects to be searched for should match *pattern* exactly.

-regexp is meaningful only when **-exp** is not used. It specifies that *pattern* is a regular expression. By default, *pattern* is treated as a simple string that can contain wildcard characters, e.g. `"*_ccir_*`.

-exp specifies that the searching criteria are expressed in *expression* using search expression syntax. Search expression enables searching for objects by properties.

-type object_type specifies what type of objects to search for. If a project is loaded, supported types can be: file, instance, and lib_vhdl. If a device is loaded, supported types can be: belsite, io_standard, site and tile.

Note When the type is "file," project sources that you added explicitly are searched by default. To also search files referenced by 'include statements, set the property "Consider Include Files in Search" to TRUE before you run the search command as follows: `project set "Consider Include Files in Search" true`

-in {project|collection} specifies the scope of the search. If you use **-in** or **-in project**, searching is within the current project. If you use **-in valid_collection**, searching is within the specified collection.

Example 1

```
% search "/stopwatch" -type instance
```

In this example, the **search** command is used to find all instances in the design.

Example 2

```
% search * -type file
```

In this example, the **search** command is used to find a list of all the source files contained in the project.

Tcl Return

A collection of objects that match the search criteria. If no matches are found, an empty collection is returned.

For More Information

For ease of use, the more detailed search documentation has been split into a number of sections. For help on a specific section, type:

```
% help search section
```

The following sections are available:

- examples (examples on how to use search command)
- expressions (an overview of search expression)
- operators (a list of operators supported by search expression)
- functions (a list of functions supported by search expression)
- approx (an overview of function - approx)
- contains (an overview of function - contains)
- exists (an overview of function - exists)
- glob (an overview of function - glob)
- property (an overview of function - property)
- quote (an overview of function - quote)
- regexp (an overview of function - regexp)
- size (an overview of function - size)
- type (an overview of function - type)
- contains_usage (detailed usage of function - contains)
- glob_usage (detailed usage of function - glob)
- regexp_usage (detailed usage of function - regexp)

Example Tcl Scripts

This chapter includes the following sections of sample Tcl scripts.

- [Sample Standard Tcl Scripts](#)
- [Sample Xilinx Tcl Script for General Use](#)
- [More Sample Xilinx Tcl Scripts](#)

You can run these example Tcl scripts the following ways:

- Enter each statement interactively at the xtclsh prompt (%). This is a good way to understand and think about each command and observe the outputs as you go.
- You can access the xtclsh prompt (%) from the command line by typing **xtclsh**, or from the Tcl console in Project Navigator.
- You can save the statements in a script file with a `.tcl` extension. To run the Tcl script, type the following from the xtclsh prompt (%):

```
% source <script_name>.tcl
```

- You can also run the script directly from the command line by running one instance of the Tcl shell followed by the script name:

```
% xtclsh <script_name>.tcl
```

Sample Standard Tcl Scripts

The following Tcl scripts illustrate basic functions in the standard Tcl language. These scripts are intended for beginners who are getting started on basic Tcl scripting. By learning more standard Tcl, you will have more capabilities modifying the above Xilinx® Tcl scripts to customize them to your individual designs. These scripts can be run from within any standard Tcl shell, or the Xilinx xtclsh.

Some of these scripts are defined as procedures. You can define a procedure, then after it is defined you can run it again and again just by typing the procedure name. For example, the first script below is called `proc Factorial{n}`. After you type the procedure in a Tcl shell (or enter the script using the `source` command), you can run it again within the Tcl shell just by typing its name, in this case:

```
% Factorial <number>; # where <number> is any input to the
function
```

The first script is a procedure called Factorial. You will recognize it as the math Factorial function. It takes one input, as you can see from the {n} following the proc statement. The open curly brace after the proc statement indicates the beginning of the set of commands that make up the procedure, and looking to the end, you can see the final result is a variable called solution.

The procedure is made up of a single loop that runs "n" times while the variable "multiplier" is incremented from 1 up to n. Each time through the loop, the solution gets larger as it is multiplied by the numbers from 1 to n. The final solution is 1 * 2 * 3 * ... * n.

```
proc Factorial{n} {
set solution 1;
set multiplier 1;
while {$multiplier <= $n } {
set solution [expr $multiplier * $solution];
set multiplier [expr $multiplier + 1];
}
return $solution;
}
```

It is also possible to write the above function recursively:

```
proc Factorial{n} {
if {$n <= 1}
{return 1;}
else { return [expr $n * [Factorial [expr $n - 1]]]
}
}
```

The following script is a procedure with 2 arguments. It is a simple representation of the Linux command-line **grep** program, which searches a file's contents for a specific pattern. The 2 arguments to this procedure are the pattern and the file(s) being searched for that pattern.

```
proc greppy {pattern fileexp} {# procedure with {arguments}
# use glob: to access filenames that match a pattern
foreach filename [glob $fileexp] {
  if {[file type $filename] eq "file"} {# file or directory?
    puts "--- Reading $filename ---"
# opens the filename and returns its file handle.
# You need the file handle to read from a file and/or write into it.
    set fh [open $filename]
# reads in the whole file into a variable!# Illustration of a benefit of Tcl's typeless variables
    set file_contents [read $fh]
    close $fh# close the file - by using its file handle.
# look for \n (end of line), and split up the lines based on
# the newlines. One line at a time is assigned to the variable "line"
    foreach line [split $file_contents \n] {
# evaluate regular expression, comparing the pattern you passed in on the command line to each line in the file.
      if [regexp $pattern $line] {
        puts $line
      }
    }
  }
}
}
```

The next script is a procedure to strip the filename off the end of a fully-qualified pathname. This script utilizes some of the many string-manipulation functions provided by Tcl. There are several ways to write this procedure, here is one that uses these string manipulation functions:

```
[string last "/" $fullfile]; # position of last slash in the string
[string length $fullfile]; # give string length
[string range $fullfile a b]; # new string from position a to b
```

consider the input: fullfile is "C:/designs/proj1/top.vhd"

Calling the following procedure with the full path name as its argument:

```
% getfname C:/designs/proj1/top.vhd
```

will return just the filename: top.vhd.

```
proc getfname {fullfile}{
  set start [expr [string last "/" $fullfile] + 1]
  set end [string length $fullfile]
  return [string range $fullfile $start $end]
}
```

You can consolidate the 3 commands of the procedure into one by omitting the intermediate variable assignments:

```
proc getfname {fullfile}{
  return [string range $fullfile \
[expr [string last "/" $fullfile] + 1] [string length $fullfile]]
}
```

Sample Tcl Script for General Use

The following script goes through a typical design process. It creates a new project, then specifies project-level properties such as device and family. Source design files are added, and process properties are set to control the options of the implementation tools. Finally, the implementation process is run. Please examine the inline comments in this script to understand the different sections and the commands being used.

```
# create and open the project and set project-level properties
project new watchvhd.xise
project set family spartan3e
project set device xc3s100e
project set package vq100
project set speed -5
# add all the source HDLs and ucf
xfile add stopwatch.vhd statmatch.vhd cnt60.vhd dcml.vhd decode.vhd smallcntr.vhd
xfile add tenths.vhd hex2led.vhd
xfile add watchvhd.ucf
# set batch application options :
# 1. set synthesis optimization goal to speed
# 2. ignore any LOCs in ngdbuild
# 3. perform timing-driven packing
# 4. use the highest par effort level
# 5. set the par extra effort level
# 6. pass "-instyle xflow" to the par command-line
# 7. generate a verbose report from trce
# 8. create the IEEE 1532 file during bitgen
project set "Optimization Goal" Speed
project set "Use LOC Constraints" false
project set "Place & Route Effort Level (Overall)" High
project set "Extra Effort (Highest PAR level only)" "Continue on Impossible"
project set "Report Type" "Verbose Report" -process "Generate Post-Place & Route Static Timing"
project set "Create IEEE 1532 Configuration File" TRUE
# run the entire xst-to-trce flow
process run "Implement Design"
# close project
project close
# open project again
project open watchvhd
# close project
project close
```

More Sample Xilinx Tcl Scripts

The following Tcl scripts illustrate some short, simple functions using the Xilinx® Tcl commands. Run these procedures within the Xilinx xtlsh with an ISE® project open.

The first script is a useful way to print out (either to your screen or to a file) a list of your current design properties for any processes you want to list. First, set up your own "Apps_list" with the names of the Xilinx processes whose properties you want to list. Next, this script opens a file for writing (the filename is `options.tcl`) and then it loops through each process in the `Apps_list`, getting a list of properties for each process. A second loop goes through each property and gets the value of each, printing it to the file. After closing the file, you can open the `options.tcl` file in an editor, or print it as a customized report of properties and their values.

```
set Apps_list {"Synthesize - XST"\
"Translate"\
"Map"\
"Generate Post-Map Static Timing"\
"Generate Post-Map Simulation Model"\
"Place & Route"\
"Generate Post-Place & Route Static Timing"\
"Generate Post-Place & Route Simulation Model"\
"Back-Annotate Pin Locations"\
"Generate Programming File"
}
set fp [open "options.tcl" "w"]
foreach ISE_app $Apps_list {
puts $fp "# ***** Properties for < $ISE_app > *****"
foreach prop [project properties -process $ISE_app] {
set val [project get "$prop" -process "$ISE_app"]
if {$val != ""} {
puts $fp "project set \"$prop\" \"$val\" -process \"$ISE_app\""
}
}
}
close $fp
```

The following script shows how you can use the standard Tcl `catch` command to capture errors before they are caught by the Tcl shell. For instance, you may want to run a long script without stopping, even if intermediate steps within the script have errors. This script also uses the Tcl `time` command to record the elapsed clock time of the process.

```
# Run XST, catch any errors, and record the runtime
if { [catch { time {process run "Synthesize - XST"} } synthTime ] } {
puts "Synthesis run failed to launch."
}
# Synthesis completed, see if it succeeded and write out the run time.
else {
set my_status [ process get "Synthesize - XST" status ]
if { ( $my_status == "up_to_date" ) ||
( $my_status == "warnings" ) } {
puts "Synthesis run completed successfully, runtime: $synthTime"
} else {
puts "Synthesis run failed, runtime: $synthTime"
}
}
}
```

The following individual commands may be useful to add to your Tcl scripts when running designs through Implement.

```
# Regenerate Core for a particular instance
process run "Regenerate Core" -instance myCore
# Set up properties to generate post place static timing report
project set "report type" "Verbose Report" \ process "Generate Post-Place & Route Static Timing"
# Set up properties to create the source control friendly version # of the bit file: the .bin file
# The .bin file has the same internals, but no header so a # simple diff works.
project set "Create Bit File" "true" project set "Create Binary Configuration File" "true"
```

ISE Design Suite Files

This appendix gives an alphabetic listing of the files used by the Xilinx® ISE® Design Suite and associated command line tools.

Name	Type	Produced By	Description
BGN	ASCII	BitGen	Report file containing information about a BitGen run
BIN	Binary	BitGen	Configuration data only
BIT	Data	BitGen	Download bitstream file for devices containing all of the configuration information from the NCD file
BLD	ASCII	NGDBuild	Report file containing information about an NGDBuild run, including the subprocesses run by NGDBuild
DATA	C File	TRACE	File created with the <code>-stamp</code> option to TRACE that contains timing model information
DC	ASCII	Synopsys FPGA Compiler	Synopsys setup file containing constraints used by ISE Design Suite and the associated command line tools.
DLY	ASCII	PAR	File containing delay information for each net in a design
DRC	ASCII	BitGen	Design Rule Check file produced by BitGen
EBC	ASCII	BitGen	Configuration data as would be read back during SEU readback, including pad frames. The EBC file has no commands in it, and is not the same as the BIT file.
EBD	ASCII	BitGen	Mask data that indicates which bits of the EBC file are essential to the circuitry of the design. The EBD file is the same size as the EBC file; the bits have one-to-one correspondence.
EDIF (various file extensions)	ASCII	CAE vendors EDIF 2 0 0 netlist writer.	EDIF netlist. The ISE Design Suite and associated command line tools will accept an EDIF 2 0 0 Level 0 netlist file
EDN	ASCII	NGD2EDIF	Default extension for an EDIF 2 0 0 netlist file
ELF	ASCII	Used for NetGen	This file populates the Block RAMs specified in the <code>.bmm</code> file.

Name	Type	Produced By	Description
EPL	ASCII	FPGA Editor	FPGA Editor command log file. The EPL file keeps a record of all FPGA Editor commands executed and output generated. It is used to recover an aborted FPGA Editor session
EXO	Data	PROMGen	PROM file in Motorola EXORMAT format
FLW	ASCII	Provided with software	File containing command sequences for XFLOW programs
GYP	ASCII	CPLDFit	CPLD guide file
HEX	Hex	PROMGen Command	Output file from PROMGen that contains a hexadecimal representation of a bitstream
IBS	ASCII	IBISWriter Command	Output file from IBISWriter that consists of a list of pins used by the design, the signals internal to the device that connect to those pins, and the IBIS buffer models for the IOBs connected to the pins
INI	ASCII	Xilinx software	Script that determines what FPGA Editor commands are performed when FPGA Editor starts up
ISC	ASCII	BitGen	Configuration data in IEEE 1532 format
JED	JEDEC	CPLDFit	Programming file to be downloaded to a device
LOG	ASCII	XFLOW TRACE	Log file containing all the messages generated during the execution of XFLOW (xflow.log) TRACE (<i>macro.log</i>)
LL	ASCII	BitGen	Optional ASCII logic allocation file with a .ll extension. The logic allocation file indicates the bitstream position of latches, flip-flops, and IOB inputs and outputs.
MEM	ASCII	User (with text editor)	User-edited memory file that defines the contents of a ROM
MCS	Data	PROMGen	PROM-formatted file in the Intel MCS-86 format
MDF	ASCII	MAP	A file describing how logic was decomposed when the design was mapped. The MDF file is used for guided mapping.
MOD	ASCII	TRACE	File created with the -stamp option in TRACE that contains timing model information
MRP	ASCII	MAP	MAP report file containing information about a technology mapper command run
MSD	ASCII	BitGen	Mask information for verification only, including pad words and frames.
MSK	Data	BitGen	File used to compare relevant bit locations when reading back configuration data contained in an operating Xilinx device

Name	Type	Produced By	Description
NAV	XML	NGDBuild	Report file containing information about an NGDBuild run, including the subprocesses run by NGDBuild. From this file, the user can click any linked net or instance names to navigate back to the net or instance in the source design.
NCD	Data	MAP, PAR, FPGA Editor	Flat physical design database correlated to the physical side of the NGD in order to provide coupling back to the users original design
NCF	ASCII	CAE Vendor toolset	Vendor-specified logical constraints files
NGA	Data	NetGen	Back-annotated mapped NCD file
NGC	Binary	XST	Netlist file with constraint information.
NGD	Data	NGDBuild	Native Generic Database (NGD) file. This file contains a logical description of the design expressed both in terms of the hierarchy used when the design was first created and in terms of lower-level Xilinx primitives to which the hierarchy resolves.
NGM	Data	MAP	File containing all of the data in the input NGD file as well as information on the physical design produced by the mapping. The NGM file is used for back-annotation.
NGO	Data	Netlist Readers	File containing a logical description of the design in terms of its original components and hierarchy
NKY	Data	BitGen	Encryption key file
NLF	ASCII	NetGen	NetGen log file that contains information on the NetGen run
NMC	Binary	FPGA Editor	Xilinx physical macro library file containing a physical macro definition that can be instantiated into a design
OPT	ASCII	XFLOW	Options file used by XFLOW
PAD	ASCII	PAR	File containing a listing of all I/O components used in the design and their associated primary pins
PAR	ASCII	PAR	PAR report file containing execution information about the PAR command run. The file shows the steps taken as the program converges on a placement and routing solution
PCF	ASCII	MAP, FPGA Editor	File containing physical constraints specified during design entry (that is, schematics) and constraints added by the user
PIN	ASCII	NetGen	Cadence signal-to-pin mapping file
PNX	ASCII	CPLDFit	File used by the IBISWriter program to generate an IBIS model for the implemented design.

Name	Type	Produced By	Description
PRM	ASCII	PROMGen	File containing a memory map of a PROM file showing the starting and ending PROM address for each BIT file loaded
RBA	ASCII	BitGen	Readback commands, rather than configuration commands, and expected readback data where the configuration data would normally be.
RBB	Binary	BitGen	Readback commands, rather than configuration commands, and expected readback data where the configuration data would normally be.
RBD	ASCII	BitGen	Expected readback data only, including pad words and frames. No commands are included.
RBT	ASCII	BitGen	Rawbits" file consisting of ASCII ones and zeros representing the data in the bitstream file
RPT	ASCII	PIN2UCF	Report file generated by PIN2UCF when conflicting constraints are discovered. The name is pinlock.rpt.
RCV	ASCII	FPGA Editor	FPGA Editor recovery file
SCR	ASCII	FPGA Editor or XFLOW	FPGA Editor or XFLOW command script file
SDF	ASCII	NetGen	File containing the timing data for a design. Standard Delay Format File
SVF	ASCII	NetGen	Assertion file written for Formality equivalency checking tool
TCL	ASCII	User (with text editor)	Tcl script file
TDR	ASCII	DRC	Physical DRC report file
TEK	Data	PROMGen	PROM-formatted file in Tektronix TEKHEX format
TV	ASCII	NetGen	Verilog test fixture file
TVHD	ASCII	NetGen	VHDL testbench file
TWR	ASCII	TRACE	Timing report file produced by TRACE
TWX	XML	TRACE	Timing report file produced by TRACE. From this file, the user can click any linked net or instance names to navigate back to the net or instance in the source design.
UCF	ASCII	User (with text editor)	User-specified logical constraints file
URF	ASCII	User (with text editor)	User-specified rules file containing information about the acceptable netlist input files, netlist readers, and netlist reader options
V	ASCII	NetGen	Verilog netlist
VHD	ASCII	NetGen	VHDL netlist
VM6	Design	CPLDFit	Output file from CPLDFit

Name	Type	Produced By	Description
VXC	ASCII	NetGen	Assertion file written for Conformal-LEC equivalence checking tool
XCT	ASCII	PARTGen	File containing detailed information about architectures and devices
XTF	ASCII	Previous releases of Xilinx software	Xilinx netlist format file
XPI	ASCII	PAR	File containing PAR run summary

EDIF2NGD and NGDBuild

This appendix describes the netlist reader program, EDIF2NGD, and how this program interacts with NGDBuild.

EDIF2NGD Overview

The EDIF2NGD program lets you read an Electronic Data Interchange Format (EDIF) 2.0 file into the Xilinx® toolset. EDIF2NGD converts an industry-standard EDIF netlist to the Xilinx-specific NGO file format. The EDIF file includes the hierarchy of the input schematic. The output NGO file is a binary database describing the design in terms of the components and hierarchy specified in the input design file. After you convert the EDIF file to an NGO file, you run NGDBuild to create an NGD file, which expands the design to include a description reduced to Xilinx primitives.

EDIF2NGD Design Flow

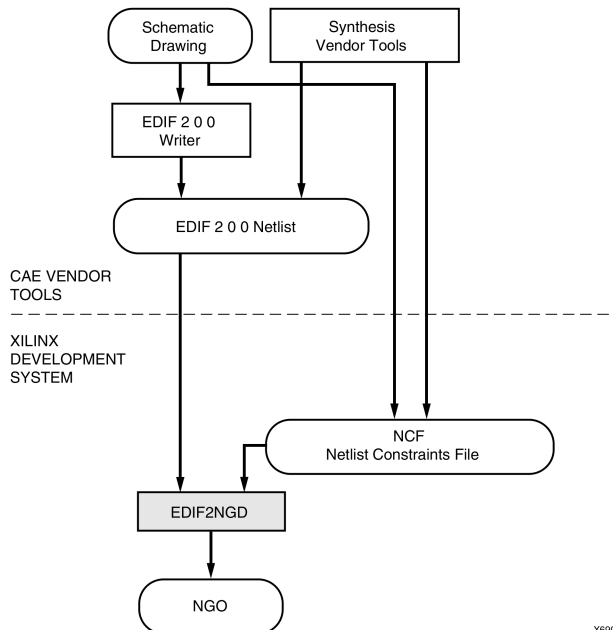

X6994

EDIF2NGD Device Support

This program is compatible with the following device families:

- 7 series
- Spartan®-3, Spartan-3A, Spartan-3E, and Spartan-6
- Virtex®-4, Virtex-5, and Virtex-6
- CoolRunner™ XPLA3 and CoolRunner-II
- XC9500 and XC9500XL

EDIF2NGD Syntax

The following command reads your EDIF netlist and converts it to an NGO file:

```
edif2ngd [options] edif_file ngo_file
```

- *options* can be any number of the EDIF2NGD options listed in [EDIF2NGD Options](#). Enter options in any order, preceded them with a dash (minus sign on the keyboard) and separate them with spaces.
- *edif_file* is the EDIF 2.0.0 input file to be converted. If you enter a file name with no extension, EDIF2NGD looks for a file with the name you specified and a `.edn` extension. If the file has an extension other than `.edn`, you must enter the extension as part of *edif_file*.

Note For EDIF2NGD to read a Mentor Graphics EDIF file, you must have installed the Mentor Graphics software component on your system. Similarly, to read a Cadence EDIF file, you must have installed the Cadence software component.

- *ngo_file* is the output file in NGO format. The output file name, its extension, and its location are determined in the following ways:
 - If you do not specify an output file name, the output file has the same name as the input file, with an `.ngo` extension.
 - If you specify an output file name with no extension, EDIF2NGD appends the `.ngo` extension to the file name.
 - If you specify a file name with an extension other than `.ngo`, you get an error message and EDIF2NGD does not run.
 - If you do not specify a full path name, the output file is placed in the directory from which you ran EDIF2NGD.

If the output file exists, it is overwritten with the new file.

EDIF2NGD Input Files

EDIF2NGD uses the following files as input:

- **EDIF file** - This is an EDIF 2 0 0 netlist file. The file must be a Level 0 EDIF netlist, as defined in the EDIF 2 0 0 specification. The Xilinx toolset can understand EDIF files developed using components from any of these libraries:
 - Xilinx Unified Libraries (described in the [Libraries Guides](#))
 - XSI (Xilinx Synopsys Interface) Libraries
 - Any Xilinx physical macros you create

Note Xilinx tools do not recognize Xilinx Unified Libraries components defined as macros; they only recognize the primitives from this library. The third-party EDIF writer must include definitions for all macros.

- **NCF file** - This Netlist Constraints File (NCF) is produced by a vendor toolset and contains constraints specified within the toolset. EDIF2NGD reads the constraints in this file and adds the constraints to the output NGO file.

EDIF2NGD reads the constraints in the NCF file if the NCF file has the same base name as the input EDIF file and an `.ncf` extension. The name of the NCF file does not have to be entered on the EDIF2NGD command line.

EDIF2NGD Output Files

The output of EDIF2NGD is an NGO file, which is a binary file containing a logical description of the design in terms of its original components and hierarchy.

EDIF2NGD Options

This section describes the EDIF2NGD command line options.

- `-a` (Add PADs to Top-Level Port Signals)
- `-aul` (Allow Unmatched LOCs)
- `-f` (Execute Commands File)
- `-intstyle` (Integration Style)
- `-l` (Libraries to Search)
- `-p` (Part Number)
- `-r` (Ignore LOC Constraints)

-a (Add PADs to Top-Level Port Signals)

This option adds PAD properties to all top-level port signals. This option is necessary if the EDIF2NGD input is an EDIF file in which PAD symbols were translated into ports. If you do not specify `-a` for one of these EDIF files, the absence of PAD instances in the EDIF file causes EDIF2NGD to read the design incorrectly. Subsequently, MAP interprets the logic as unused and removes it.

Syntax

`-a`

In all Mentor Graphics and Cadence EDIF files, PAD symbols are translated into ports. For EDIF files from either of these vendors, the `-a` option is set automatically; you do not have to enter the `-a` option on the EDIF2NGD command line.

-aul (Allow Unmatched LOCs)

By default (without the **-aul** option), EDIF2NGD generates an error if the constraints specified for pin, net, or instance names in the NCF file cannot be found in the design. If this error occurs, an NGO file is not written. If you enter the **-aul** option, EDIF2NGD generates a warning instead of an error for LOC constraints and writes an NGO file.

You may want to run EDIF2NGD with the **-aul** option if your constraints file includes location constraints for pin, net, or instance names that have not yet been defined in the HDL or schematic. This allows you to maintain one version of your constraints files for both partially complete and final designs.

Syntax

-aul

Note When using this option, make sure you do not have misspelled net or instance names in your design. Misspelled names may cause inaccurate placing and routing.

-f (Execute Commands File)

This option executes the command line arguments in the specified *command_file*.

Syntax

-f *command_file*

For more information on the **-f** option, see [-f \(Execute Commands File\)](#) in the Introduction chapter.

-intstyle (Integration Style)

This option limits screen output, based on the integration style that you are running, to warning and error messages only.

Syntax

-intstyle *ise|xflow|silent*

When using **-intstyle**, one of three modes must be specified:

- **-intstyle ise** indicates the program is being run as part of an integrated design environment.
- **-intstyle xflow** indicates the program is being run as part of an integrated batch flow.
- **-intstyle silent** limits screen output to warning and error messages only.

Note **-intstyle** is automatically invoked when running in an integrated environment such as Project Navigator or XFLOW.

-l (Libraries to Search)

This option specifies a library to search when determining what library components were used to build the design. This information is necessary for NGDBuild, which must determine the source of the design components before it can resolve the components to Xilinx® primitives.

Syntax

-l *libname*

You may specify multiple **-l** options on the command line, but Each instance must be preceded with **-l**. For example, **-l xilinxun synopsys** is not acceptable, while **-l xilinxun -l synopsys** is acceptable.

The allowable entries for *libname* are the following.

- **xilinxun** (For Xilinx Unified library)
- **synopsys**

Note You do not have to enter **xilinxun** with a **-l** option. The Xilinx tools automatically access these libraries. You do not have to enter **synopsys** with a **-l** option if the EDIF netlist contains an author construct with the string Synopsys. In this case, EDIF2NGD automatically detects that the design is from Synopsys.

-p (Part Number)

This option specifies the part into which your design is implemented.

Note If you do not specify a part when you run EDIF2NGD, you must specify one when you run NGDBuild.

Syntax

`-p part number`

part_number must be a complete Xilinx® part name including device, package and speed information (example: xc4vlx60-10- ff256).

Note For syntax details and examples, see [-p \(Part Number\)](#) in the Introduction chapter.

-r (Ignore LOC Constraints)

This option filters out all location constraints (LOC=) from the design. If the output file already exists, it is overwritten with the new file.

Syntax

`-r`

NGDBuild

NGDBuild performs all the steps necessary to read a netlist file in EDIF format and create an NGD file describing the logical design. The NGD file resulting from an NGDBuild run contains both a logical description of the design reduced to NGD primitives and a description in terms of the original hierarchy expressed in the input netlist. The output NGD file can be mapped to the desired device family.

This program is compatible with the following device families:

- 7 series
- Spartan®-3, Spartan-3A, Spartan-3E, and Spartan-6
- Virtex®-4, Virtex-5, and Virtex-6
- CoolRunner™ XPLA3 and CoolRunner-II
- XC9500 and XC9500XL

Converting a Netlist to an NGD File

The following figure shows the NGDBuild conversion process.

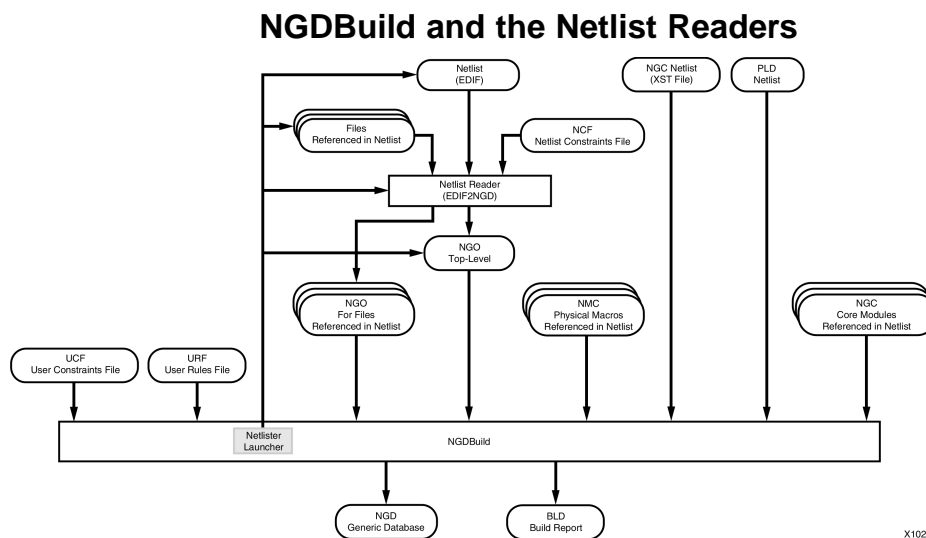

NGDBuild performs the following steps to convert a netlist to an NGD file:

1. Reads the source netlist

To perform this step, NGDBuild invokes the Netlist Launcher (Netlister), a part of the NGDBuild software which determines the type of the input netlist and starts the appropriate netlist reader program. If the input netlist is in EDIF format, the Netlist Launcher invokes EDIF2NGD. If the input netlist is in another format that the Netlist Launcher recognizes, the Netlist Launcher invokes the program necessary to convert the netlist to EDIF format, then invokes EDIF2NGD. The netlist reader produces an NGO file for the top-level netlist file.

If any subfiles are referenced in the top-level netlist (for example, a PAL description file, or another schematic file), the Netlist Launcher invokes the appropriate netlist reader for each of these files to convert each referenced file to an NGO file.

The Netlist Launcher is described in [Netlist Launcher \(Netlister\)](#). The netlist reader programs are described in [the EDIF2NGD Overview](#).

2. Reduces all components in the design to NGD primitives

To perform this step, NGDBuild merges components that reference other files by finding the referenced NGO files. NGDBuild also finds the appropriate system library components, physical macros (NMC files) and behavioral models.

3. Checks the design by running a Logical DRC (Design Rule Check) on the converted design

The Logical DRC is a series of tests on the logical design. It is described in the [Logical Design Rule Check chapter](#).

4. Writes an NGD file as output

When NGDBuild reads the source netlist, it detects any files or parts of the design that have changed since the last run of NGDBuild. It updates files as follows:

- If you modified your input design, NGDBuild updates all of the files affected by the change and uses the updated files to produce a new NGD file.

The Netlist Launcher checks timestamps (date and time information) for netlist files and intermediate NGDBuild files (NGOs). If an NGO file has a timestamp earlier than the netlist file that produced it, the NGO file is updated and a new NGD file is produced.

- NGDBuild completes the NGD production if all or some of the intermediate files already exist. These files may exist if you ran a netlist reader before you ran NGDBuild. NGDBuild uses the existing files and creates the remaining files necessary to produce the output NGD file.

Note If the NGO for an netlist file is up to date, NGDBuild looks for an NCF file with the same base name as the netlist in the netlist directory and compares the timestamp of the NCF file against that of the NGO file. If the NCF file is newer, EDIF2NGD is run again. However, if an NCF file existed on a previous run of NGDBuild and the NCF file was deleted, NGDBuild does not detect that EDIF2NGD must be run again. In this case, you must use the `-nt on` option to force a rebuild. The `-nt on` option must also be used to force a rebuild if you change any of the EDIF2NGD options.

Syntax, files, and options for NGDBuild are described in the [NGDBuild chapter](#).

Bus Matching

When NGDBuild encounters an instance of one netlist within another netlist, it requires that each pin specified on the upper-level instance match to a pin (or port) on the lower-level netlist. Two pins must have exactly the same name in order to be matched. This requirement applies to all FPGAs and CPLDs supported for NGDBuild.

If the interface between the two netlists uses bused pins, these pins are expanded into scalar pins before any pin matching occurs. For example, the pin `A[7:0]` might be expanded into 8 pins named `A[7]` through `A[0]`. If both netlists use the same nomenclature (that is, the same index delimiter characters) when expanding the bused pin, the scalar pin names will match exactly. However, if the two netlists were created by different vendors and different delimiters are used, the resulting scalar pin names do not match exactly.

In cases where the scalar pin names do not match exactly, NGDBuild analyzes the pin names in both netlists and attempts to identify names that resulted from the expansion of bused pins. When it identifies a bus-expanded pin name, it tries several other bus-naming conventions to find a match in the other netlist so it can merge the two netlists. For example, if it finds a pin named `A(3)` in one netlist, it looks for pins named `A(3)`, `A[3]`, `A<3>` or `A3` in the other netlist.

The following table lists the bus naming conventions understood by NGDBuild.

Bus Naming Conventions

Naming Convention	Example
<i>busname(index)</i>	DI(3)
<i>busname<index></i>	DI<3>
<i>busname[index]</i>	DI[3]
<i>busnameindex</i>	DI3

If your third-party netlist writer allows you to specify the bus-naming convention, use one of the conventions shown in the preceding table to avoid pin mismatch errors during NGDBuild. If your third-party EDIF writer preserves bus pins using the EDIF array construct, the bus pins are expanded by EDIF2NGD using parentheses, which is one of the supported naming conventions.

Note NGDBuild support for bused pins is limited to this understanding of different naming conventions. It is not able to merge together two netlists if a bused pin has different indices between the two files. For example, it cannot match `A[7:0]` in one netlist to `A[15:8]` in another.

In the Xilinx® UnifiedPro library, some of the pins on the block RAM primitives are bused. If your third-party netlist writer uses one of the bus naming conventions listed in the preceding table or uses the EDIF array construct, these primitives are recognized properly by NGDBuild. The use of any other naming convention may result in an unexpanded block error during NGDBuild.

Netlist Launcher (Netlister)

The Netlist Launcher, which is part of NGDBuild, translates an EDIF netlist to an NGO file. NGDBuild uses this NGO file to create an NGD file.

Note The NGC netlist file does not require Netlist Launcher processing. It is equivalent to an NGO file.

When NGDBuild is invoked, the Netlist launcher goes through the following steps:

1. The Netlist Launcher initializes itself with a set of rules for determining what netlist reader to use with each type of netlist, and the options with which each reader is invoked.

The rules are contained in the system rules file (described in [System Rules File](#)) and in the user rules file (described in [User Rules File](#)).

2. NGDBuild makes the directory of the top-level netlist the first entry in the Netlist Launchers list of search paths.
3. For the top-level design and for each file referenced in the top-level design, NGDBuild queries the Netlist Launcher for the presence of the corresponding NGO file.
4. For each NGO file requested, the Netlist Launcher performs the following actions:

- Determines what netlist is the source for the requested NGO file

The Netlist Launcher determines the source netlist by looking in its rules database for the list of legal netlist extensions. Then, it looks in the search path (which includes the current directory) for a netlist file possessing a legal extension and the same name as the requested NGO file.

- Finds the requested NGO file

The Netlist Launcher looks first in the directory specified with the `-dd` option (or current directory if a directory is not specified). If the NGO file is not found there and the source netlist was not found in the search path, the Netlist Launcher looks for the NGO file in the search path.

- Determines whether the NGO file must be created or updated

If neither the netlist source file nor the NGO file is found, NGDBuild exits with an error.

If the netlist source file is found but the corresponding NGO file is not found, the Netlist Launcher invokes the proper netlist reader to create the NGO file.

If the netlist source file is not found but the corresponding NGO file is found, the Netlist Launcher indicates to NGDBuild that the file exists and NGDBuild uses this NGO file.

If both the netlist source file and the corresponding NGO file are found, the netlist files time stamp is checked against the NGO files timestamp. If the timestamp of the NGO file is later than the source netlist, the Netlist Launcher returns a found status to NGDBuild. If the timestamp of the NGO file is earlier than the netlist source, or the NGO file is not present in the expected location, then the Launcher creates the NGO file from the netlist source by invoking the netlist reader specified by its rules.

Note The timestamp check can be overridden by options on the NGDBuild command line. The `-nt` option updates all existing NGO files, regardless of their timestamps. The `-nt off` option does not update any existing NGO files, regardless of their timestamps.

5. The Netlist launcher indicates to NGDBuild that the requested NGO files have been found, and NGDBuild can process all of these NGO files.

Netlist Launcher Rules Files

The behavior of the Netlist Launcher is determined by rules defined in the system rules file and the user rule file. These rules determine the following:

- What netlist source files are acceptable
- Which netlist reader reads each of these netlist files
- What the default options are for each netlist reader

The system rules file contains the default rules supplied by Xilinx®. The user rules file can add to or override the system rules.

User Rules File (URF)

The user rules file can add to or override the rules in the system rules file. You can specify the location of the user rules file with the **-ur** option. The user rules file must have a `.urf` extension. See [-ur \(Read User Rules File\)](#) in this chapter for more information.

User Rules and System Rules

User rules are treated as follows:

- A user rule can override a system rule if it specifies the same source and target files as the system rule.
- A user rule can supplement a system rule if its target file is identical to a system rules source file, or if its source file is the same as a system rules target file.
- A user rule that has a source file identical to a system rules target file and a target file that is identical to the same system rules source file is illegal, because it defines a loop.

User Rules Format

Each rule in the user rules file has the following format:

```
RuleName = <rulename1>;
<key1>   = <value1>;
<key2>   = <value2>;
.
.
.
<keyn>   = <valuen>;
```

Following are the keys allowed and the values expected:

Note The value types for the keys are described in Value Types in Key Statements below.

- **RuleName** - This key identifies the beginning of a rule. It is also used in error messages relating to the rule. It expects a RULENAME value. A value is required.
- **NetlistFile** - This key specifies a netlist or class of netlists that the netlist reader takes as input. The extension of NetlistFile is used together with the TargetExtension to identify the rule. It expects either a FILENAME or an EXTENSION value. If a file name is specified, it should be just a file name (that is, no path). Any leading path is ignored. A value is required.
- **TargetExtension** - This key specifies the class of files generated by the netlist reader. It is used together with the extension from NetlistFile to identify the rule. It expects an EXTENSION value. A value is required.
- **Netlister** - This key specifies the netlist reader to use when translating a specific netlist or class of netlists to a target file. The specific netlist or class of netlists is specified by NetlistFile, and the class of target files is specified by TargetExtension. It expects an EXECUTABLE value. A value is required.

- **NetlisterTopOptions** - This key specifies options for the netlist reader when compiling the top-level design. It expects an OPTIONS value or the keyword NONE. Included in this string should be the keywords \$INFILE and \$OUTFILE, in which the input and output files is substituted. In addition, the following keywords may appear.
 - **\$PART** - The part passed to NGDBuild by the -p option is substituted. It may include architecture, device, package and speed information. The syntax for a \$PART specification is the same as described in -p (Part Number) in the Introduction chapter.
 - **\$FAMILY** - The family passed to NGDBuild by the -p option is substituted. A value is optional.
 - **\$DEVICE** - The device passed to NGDBuild by the -p option is substituted. A value is optional.
 - **\$PKG** - The package passed to NGDBuild by the -p option is substituted. A value is optional.
 - **\$SPEED** - The speed passed to NGDBuild by the -p option is substituted. A value is optional.
 - **\$LIBRARIES** - The libraries passed to NGDBuild. A value is optional.
 - **\$IGNORE_LOCS** - Substitute the -r option to EDIF2NGD if the NGDBuild command line contained a -r option.
 - **\$ADD_PADS** - Substitute the -a option to EDIF2NGD if the NGDBuild command line contained a -a option.

The options in the NetlisterTopOptions line must be enclosed in quotation marks.

- **NetlisterOptions** - This key specifies options for the netlist reader when compiling sub-designs. It expects an OPTIONS value or the keyword NONE. Included in this string should be the keywords \$INFILE and \$OUTFILE, in which the input and output files is substituted. In addition, any of the keywords that may be entered for the NetlisterTopOptions key may also be used for the NetlisterOptions key.

The options in the NetlisterOptions line must be enclosed in quotation marks.

- **NetlisterDirectory** - This key specifies the directory in which to run the netlist reader. The launcher changes to this directory before running the netlist reader. It expects a DIR value or the keywords \$SOURCE, \$OUTPUT, or NONE, where the path to the source netlist is substituted for \$SOURCE, the directory specified with the -dd option is substituted for \$OUTPUT, and the current working directory is substituted for NONE. A value is optional.
- **NetlisterSuccessStatus** - This key specifies the return code that the netlist reader returns if it ran successfully. It expects a NUMBER value or the keyword NONE. The number may be preceded with one of the following: =, <, >, or !. A value is optional.

Value Types in Key Statements

The value types used in the preceding key statements are the following:

- **RULENAME** -Any series of characters except for a semicolon ; and white space (for example, space, tab, newline).
- **EXTENSION** -A . followed by an extension that conforms to the requirements of the platform.
- **FILENAME** -A file name that conforms to the requirements of the platform.
- **EXECUTABLE** -An executable name that conforms to the requirements of the platform. It may be a full path to an executable or just an executable name. If it is just a name, then the \$PATH environment variable is used to locate the executable.
- **DIR** -A directory name that conforms to the requirements of the platform.
- **OPTIONS** -Any valid string of options for the executable.
- **NUMBER** -Any series of digits.
- **STRING** -Any series of characters in double quotes.

System Rules File

The system rules are shown following. The system rules file is not an ASCII file, but for the purpose of describing the rules, the rules are described using the same syntax as in the user rules file. This syntax is described in [User Rules File](#).

Note If a rule attribute is not specified, it is assumed to have the value NONE.

System Rules File

```
#####
# edif2ngd rules
#####

RuleName = EDN_RULE;
NetlistFile = .edn;
TargetExtension = .ngo;
Netlister = edif2ngd;
NetlisterTopOptions = "[${IGNORE_LOCS}] [${ADD_PADS}] [${QUIET}] [${AUL}] {-1 $LIBRARIES} $INFILE $OUTFILE";
NetlisterOptions = "-noa [${IGNORE_LOCS}] {-1 $LIBRARIES} $INFILE $OUTFILE";
NetlisterDirectory = NONE;
NetlisterSuccessStatus = 0;

RuleName = EDF_RULE;
NetlistFile = .edf;
TargetExtension = .ngo;
Netlister = edif2ngd;
NetlisterTopOptions = "[${IGNORE_LOCS}] [${ADD_PADS}] [${QUIET}] [${AUL}] {-1 $LIBRARIES} $INFILE $OUTFILE";
NetlisterOptions = "-noa [${IGNORE_LOCS}] {-1 $LIBRARIES} $INFILE $OUTFILE";
NetlisterDirectory = NONE;
NetlisterSuccessStatus = 0;

RuleName = EDIF_RULE;
NetlistFile = .edif;
TargetExtension = .ngo;
Netlister = edif2ngd;
NetlisterTopOptions = "[${IGNORE_LOCS}] [${ADD_PADS}] [${QUIET}] [${AUL}] {-1 $LIBRARIES} $INFILE $OUTFILE";
NetlisterOptions = "-noa [${IGNORE_LOCS}] {-1 $LIBRARIES} $INFILE $OUTFILE";
NetlisterDirectory = NONE;
NetlisterSuccessStatus = 0;

RuleName = SYN_EDIF_RULE;
NetlistFile = .sedif;
TargetExtension = .ngo;
Netlister = edif2ngd;
NetlisterTopOptions = NONE;
NetlisterOptions = "-l synopsys [${IGNORE_LOCS}] {-1 $LIBRARIES} $INFILE $OUTFILE";
NetlisterDirectory = NONE;
NetlisterSuccessStatus = 0;
```

Rules File Examples

This section provides examples of system and user rules. The first example is the basis for understanding the ensuing user rules examples.

Example 1: EDF_RULE System Rule

As shown in the [System Rules File](#), the EDF_RULE system rule is defined as follows.

```
RuleName = EDF_RULE;
NetlistFile = .edf;
TargetExtension = .ngo;
Netlister = edif2ngd;
NetlisterTopOptions = "[${IGNORE_LOCS}] [${ADD_PADS}] [${QUIET}] [${AUL}] {-l $LIBRARIES} $INFILE $OUTFILE";
NetlisterOptions = "-noa [${IGNORE_LOCS}] {-l $LIBRARIES} $INFILE $OUTFILE";
NetlisterDirectory = NONE;
NetlisterSuccessStatus = 0;
```

The EDF_RULE instructs the Netlist Launcher to use EDIF2NGD to translate an EDIF file to an NGO file. If the top-level netlist is being translated, the options defined in NetlisterTopOptions are used; if a lower-level netlist is being processed, the options defined by NetlisterOptions are used. Because NetlisterDirectory is NONE, the Netlist Launcher runs EDIF2NGD in the current working directory (the one from which NGDBuild was launched). The launcher expects EDIF2NGD to issue a return code of 0 if it was successful; any other value is interpreted as failure.

Example 2: User Rule

```
// URF Example 2
RuleName = OTHER_RULE; // end-of-line comments are also allowed
NetlistFile = .oth;
TargetExtension = .edf;
Netlister = other2edf;
NetlisterOptions = "$INFILE $OUTFILE";
NetlisterSuccessStatus = 1;
```

The user rule OTHER_RULE defines a completely new translation, from a hypothetical OTH file to an EDIF file. To do this translation, the other2edf program is used. The options defined by NetlisterOptions are used for translating all OTH files, regardless of whether they are top-level or lower-level netlists (because no explicit NetlisterTopOptions is given). The launcher expects other2edf to issue a return code of 1 if it was successful; any other value be interpreted as failure.

After the Netlist Launcher uses OTHER_RULE to run other2edf and create an EDIF file, it uses the EDF_RULE system rule (shown in the preceding section) to translate the EDIF file to an NGO file.

Example 3: User Rule

```
// URF Example 3
RuleName = EDF_LIB_RULE;
NetlistFile = .edf;
TargetExtension = .ngo;
NetlisterOptions = "-l xilinxun $INFILE $OUTFILE";
```

Because both the NetlistFile and TargetExtension of this user rule match those of the system rule EDF_RULE (shown in Example 1: EDF_RULE System Rule), the EDF_LIB_RULE overrides the EDF_RULE system rule. Any settings that are not defined by the EDF_LIB_RULE are inherited from EDF_RULE. So EDF_LIB_RULE uses the same netlister (EDIF2NGD), the same top-level options, the same directory, and expects the same success status as EDF_RULE. However, when translating lower-level netlists, the options used are only **-l xilinxun \$INFILE \$OUTFILE**. (There is no reason to use **-l xilinxun** on EDIF2NGD; this is for illustrative purposes only.)

Example 4: User Rule

```
// URF Example 4
RuleName = STATE_EDF_RULE;
NetlistFile = state.edf;
TargetExtension = .ngo;
Netlister = state2ngd;
```

Although the NetlistFile is a complete file name, this user rule also matches the system rule EDF_RULE (shown in Example 1: EDF_RULE System Rule), because the extensions of NetlistFile and TargetExtension match. When the Netlist Launcher tries to make a file called state.ngo, it uses this rule instead of the system rule EDF_RULE (assuming that state.edf exists). As with the previous example, the unspecified settings are inherited from the matching system rule. The only change is that the fictitious program state2ngd is used in place of EDIF2NGD.

Note If EDF_LIB_RULE (from the example in Example 3: User Rule) and this rule were both in the user rules file, STATE_EDF_RULE includes the modifications made by EDF_LIB_RULE. So a lower-level state.edf is translated by running state2ngd with the `-l xilinxun` option.

NGDBuild File Names and Locations

Following are some notes about file names in NGDBuild:

- An intermediate file has the same root name as the design that produced it. An intermediate file is generated when more than one netlist reader is needed to translate a netlist to a NGO file.
- Netlist root file names in the search path must be unique. For example, if you have the design state.edn, you cannot have another design named state in any of the directories specified in the search path.
- NGDBuild and the Netlist Launcher support quoted file names. Quoted file names may have special characters (for example, a space) that are not normally allowed.
- If the output directory specified in the call to NGDBuild is not writable, an error is displayed and NGDBuild fails.

Additional Resources

- Xilinx Glossary - <http://www.xilinx.com/company/terms.htm>
- Xilinx Support and Documentation - <http://www.xilinx.com/support>