



Cancer

(I can grow if I want to! Just try and stop
me . . .)

Definitions

“Benign”

Malignant

Carcinoma

Sarcoma

Leukemia

Lymphoma

Definitions

Tumor Suppressor

Oncogene

Proto-oncogene

Signaling and Cell Growth

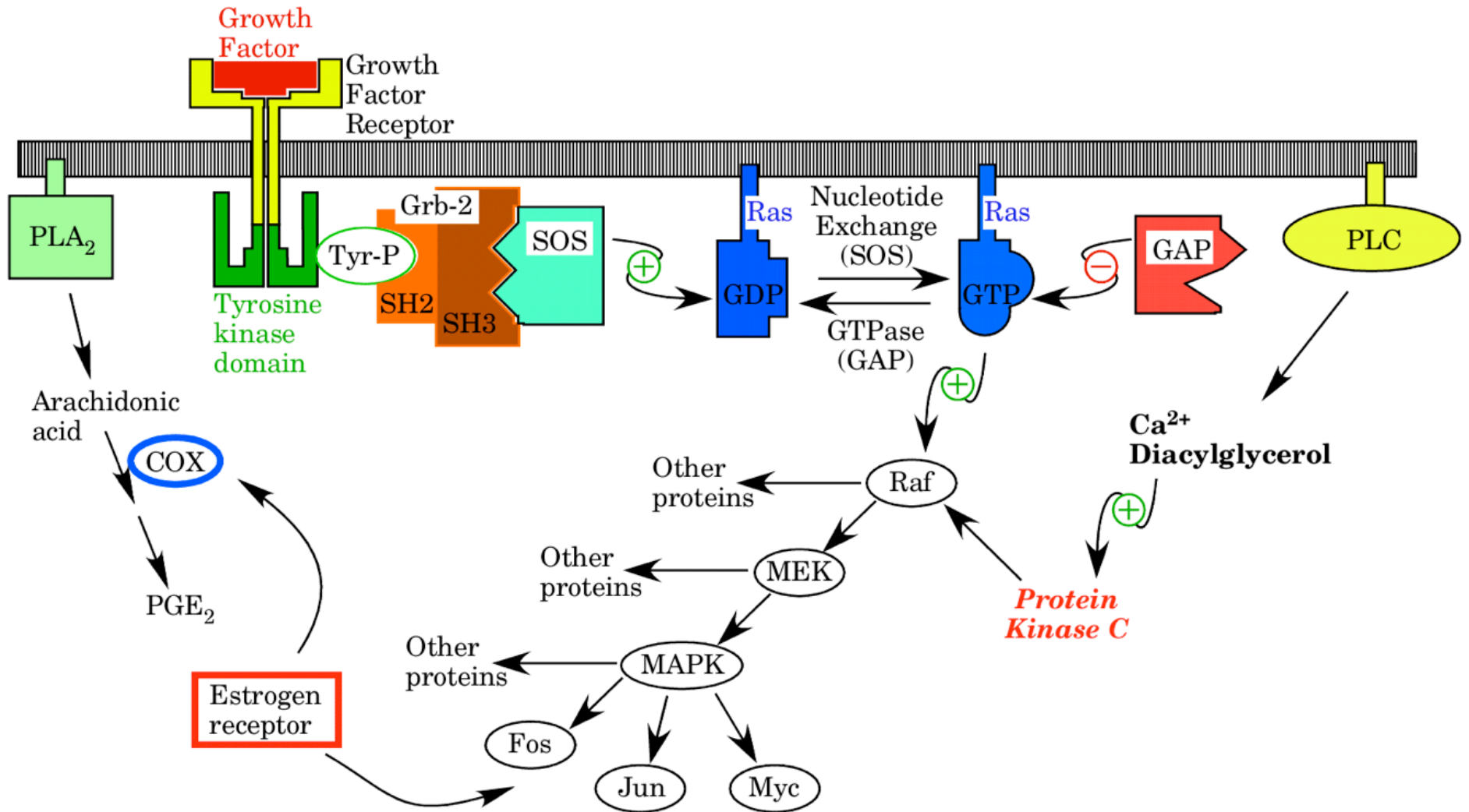

Wnt Signaling

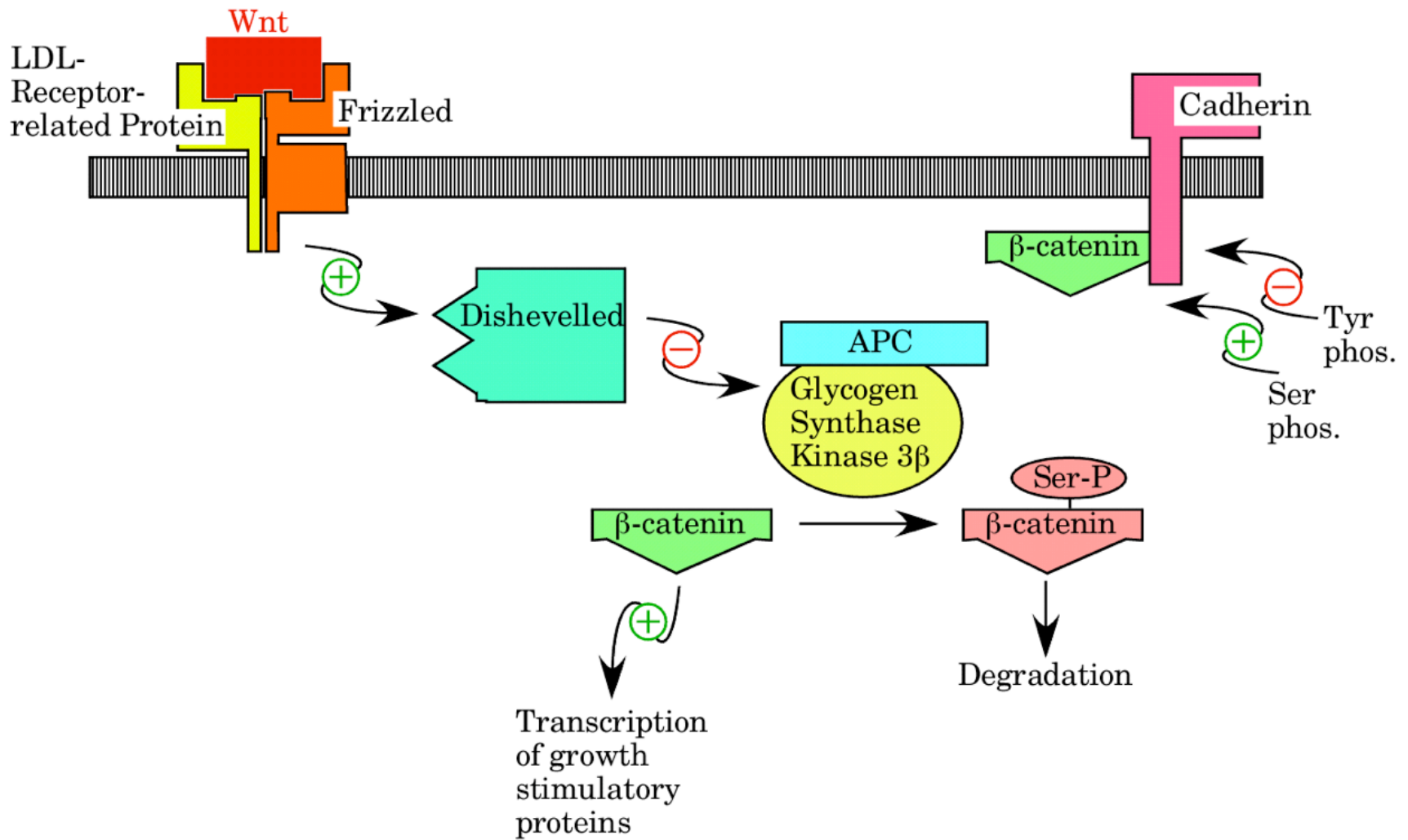

Apoptosis

Extrinsic Pathway

FAS, TNF

Intrinsic Pathway

Cytochrome *c*

Caspase

Carcinogens

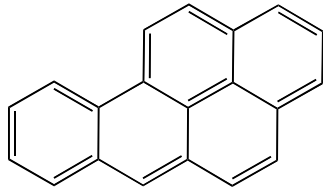

Benzo[a]pyrene

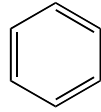

Benzene

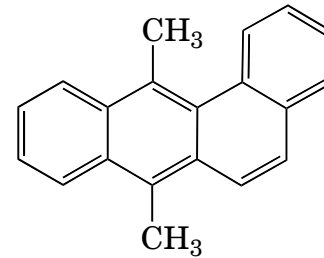

9,10-Dimethyl-
1,2-benzanthracene
(DMBA)

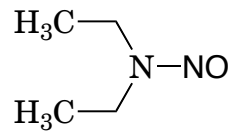

N-Nitrosodiethylamine

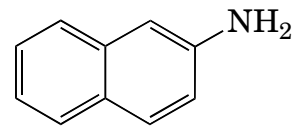

2-Naphthylamine

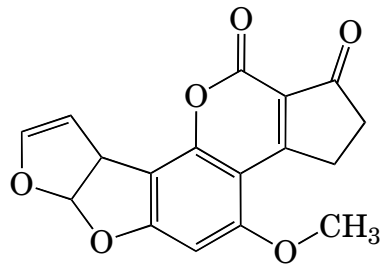

Aflatoxin

Tumor Promoters

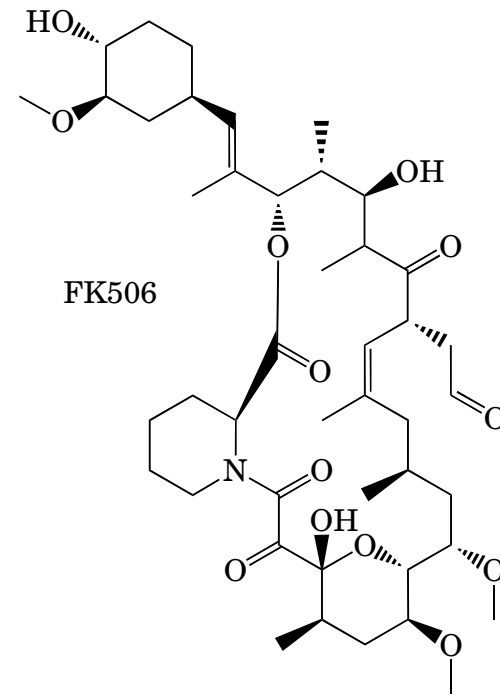
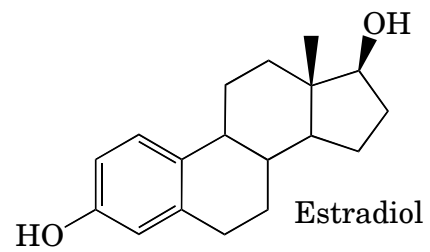
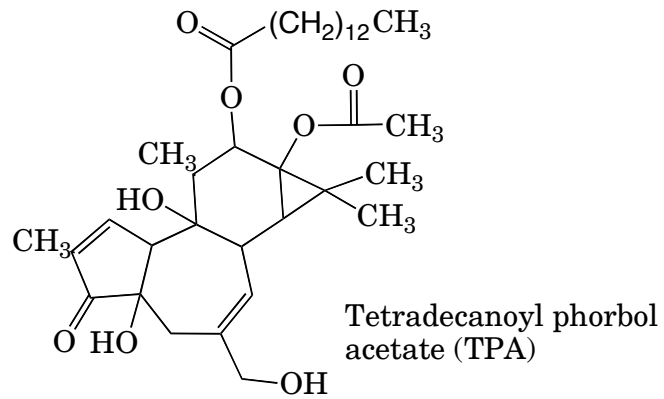

Cytotoxic Chemotherapeutic Agents

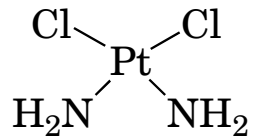

Cisplatin

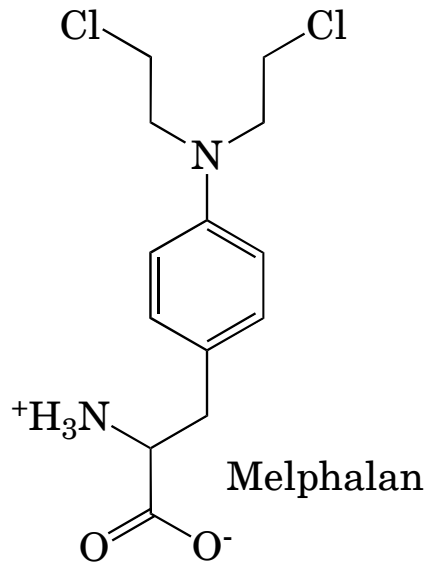

Melphalan

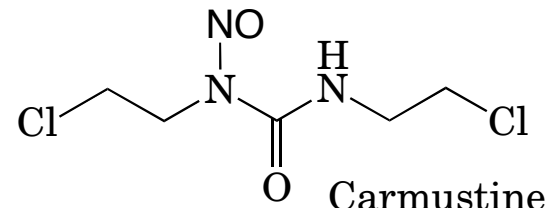

Carmustine

Cytotoxic Chemotherapeutic Agents

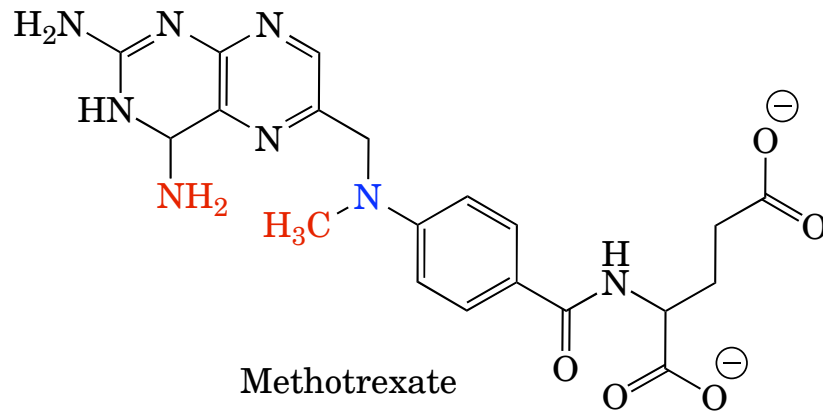
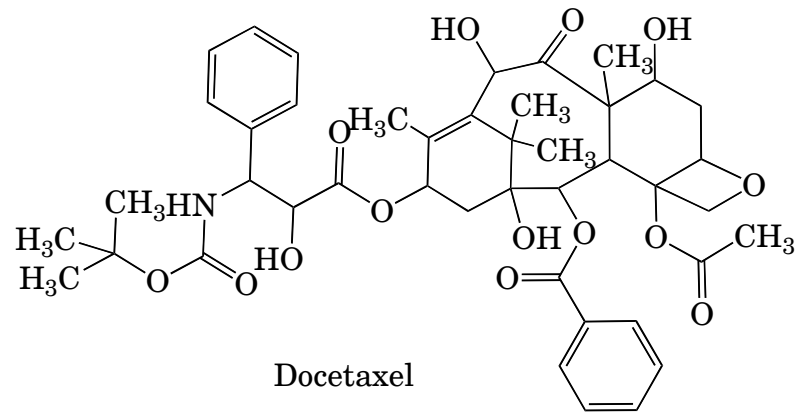
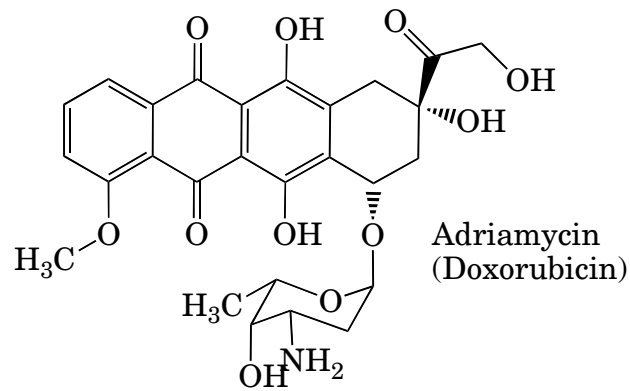

Targeted Anti-tumor Agents

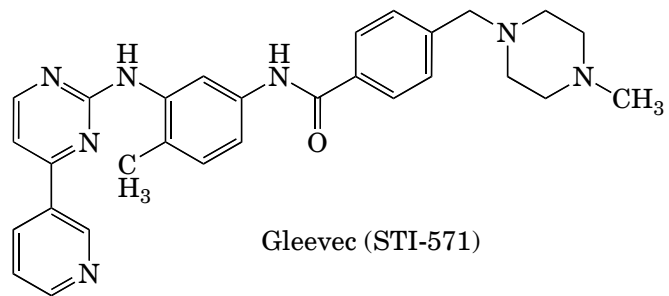

Gleevec (STI-571)

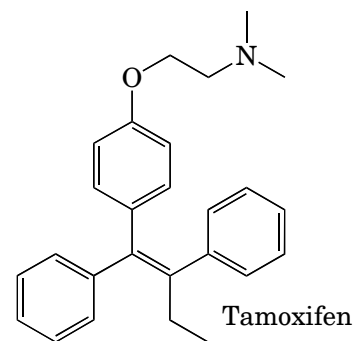

Tamoxifen

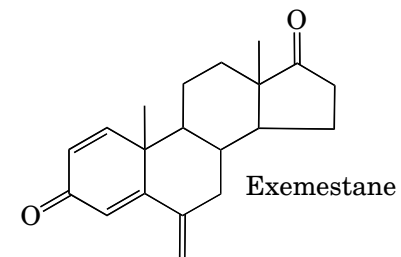

Exemestane

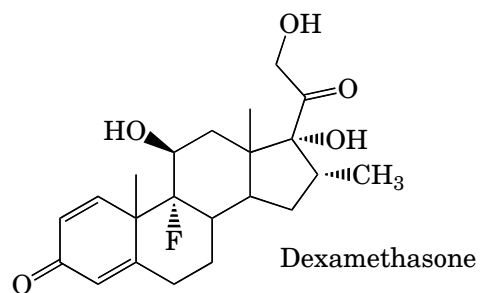

Dexamethasone

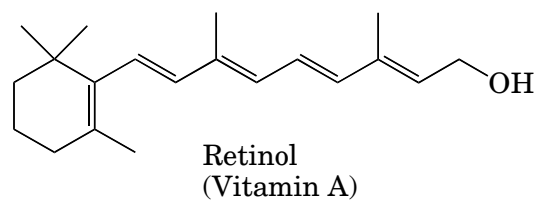

Retinol
(Vitamin A)

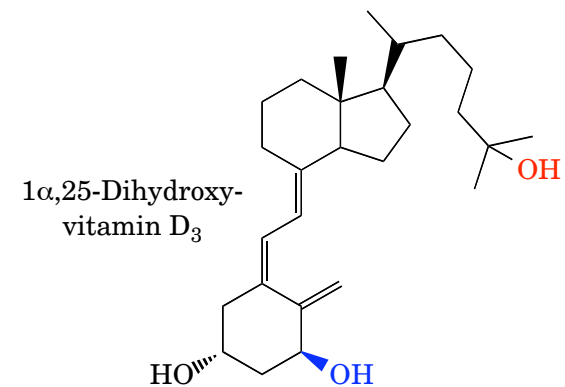

1 α ,25-Dihydroxy-
vitamin D₃

Angiogenesis

VEGF (Vascular Endothelial Growth Factor)