

ROSE-
HULMAN
UNDERGRADUATE
MATHEMATICS
JOURNAL

A METACALIBRATION PROOF OF THE
ISOPERIMETRIC PROBLEM

James Dilts^a

VOLUME 11, No. 2, FALL 2010

Sponsored by

Rose-Hulman Institute of Technology

Department of Mathematics

Terre Haute, IN 47803

Email: mathjournal@rose-hulman.edu

<http://www.rose-hulman.edu/mathjournal>

^aBrigham Young University, Provo, UT

ROSE-HULMAN UNDERGRADUATE MATHEMATICS JOURNAL
VOLUME 11, No. 2, FALL 2010

A METACALIBRATION PROOF OF THE ISOPERIMETRIC PROBLEM

James Dilts

Abstract. The isoperimetric problem asks, among all figures with the same perimeter (iso-perimetric means “same perimeter”), which has the greatest area. This paper proves the classic isoperimetric problem using a generalization of calibration techniques which we call metacalibration. We then generalize to arbitrary dimensions and to spherical spaces.

1 Introduction

The isoperimetric problem is a classical problem of geometry. The basic question asks, among all figures with the same perimeter (iso-perimetric means “same perimeter”), which has the greatest area. The original problem is deceptively difficult to prove, and thus escaped a rigorous proof until Weierstrass in 1879 [9].

Isoperimetric problems have a long history. The first example we have in history is a story given about Dido, Queen of Cartage in Africa. She sailed to northern Africa from Phoenicia, and the locals agreed to give her as much land as she could enclose with the skin of an ox. Being clever, she cut the oxhide into very thin strips, and thereby had enough length to encircle an entire nearby hill. By using the shape of a circle, she maximized her gains from the deal [8].

As with most geometric problems, the ancient Greeks also worked on this problem. The earliest result was given by Zenodorus in a now lost text. Other ancient authors cite him though, letting us know that he proved that the circle has greater area than any polygon with the same perimeter [1]. This is an impressive result, considering the tools available to him.

New and powerful tools for optimization problems in general, and thus the isoperimetric problem as well, were discovered with the invention of calculus by Newton and Leibniz. Their work provided one of the first systematic ways to prove minimization. But one of the main problems with the methods was that it was very difficult to prove that a optimizing figure actually exists. (For example, remember the classic calculus example, $f(x) = x^3 - x$, which has a local minimum at $3^{-1/2}$ but has no global minimum.)

For instance, Steiner in 1838 gave an argument that seemed to show that the circle maximized area [6]. His argument showed that the maximizer must be both convex and symmetric in all directions. The only figure satisfying this is the circle, but that does not show that the circle is actually the maximizer. It only showed that if such a maximizer did exist, it must be the circle. Weierstrass, in 1879, was finally able to show that the circle was in fact the true maximizer [9].

Up till recently, most approaches to this type of problem employed indirect methods such as calculus of variations. This method is very similar to the idea of finding an extremum by taking the first derivative. However, the complexity involved is a serious barrier in many problems. Also, there is the worry of finding a local rather than a global maximum and the difficulty of proving that there is in fact a global maximum at all.

Direct methods, such as calibration, work differently. Rather than look at other shapes close to the original figure (like a derivative), it picks the figure it thinks is best and then directly compares it in some way to every other figure we are considering. Calibration cannot handle isoperimetry directly, and so we usually look at the dual problem of finding the figure of constant area with minimized perimeter. Calibration, along with other direct methods, would then be attempting to show that for μ , the proposed minimizer, and σ , an element in the class of competitors for the problem, and P , a measurement function,

$$P(\mu) \leq P(\sigma)$$

(For the isoperimetric problem, this class of competitors is likely the set of manifolds enclosing a particular area, and P measures the total perimeter of the figure.) However, proving this inequality as stated is the original problem, only with μ fixed. Calibrations introduces an intermediate inequality to make proving this easier. It uses a closed vector field φ to show that

$$P(\mu) = \int_{\mu} \varphi \cdot \vec{n} = \int_{\sigma} \varphi \cdot \vec{n} \leq P(\sigma).$$

If this set of inequalities can be set up, then μ minimizes P . Calibration has been very successful at solving problems involving fixed boundaries due to some of the properties of vector fields and their integration, but so far has been stumped by problems of fixed area, such as the dual of the isoperimetric problem mentioned above.

Metacalibration, developed by Dr. Gary Lawlor of Brigham Young University, employs a similar methodology to calibration but introduces new tools allowing it to solve new types of problems. One such class of problems are what we call equitent problems, which seek to find the minimum perimeter or surface area to contain a given area and span a boundary. For example, what shape spans the four vertices of a square and contains a certain area? Some work has already been done on these problems [3].

The basis of the metacalibration proof is the attempt to find *any* intermediate function G on the figures such that we can set up the set of inequalities

$$P(\mu) = G(\mu) \leq G(\sigma) \leq P(\sigma).$$

The similarity of metacalibration to standard calibration can be seen by interpreting G as the integral of a vector field over the figure. Then the equations become

$$P(\mu) = \int_{\mu} \varphi_{\mu} \cdot \vec{n} \leq \int_{\sigma} \varphi_{\sigma} \cdot \vec{n} \leq P(\sigma).$$

which is almost exactly the same as calibration. But notice how φ changes based on each figure. This small, seemingly insignificant change is actually quite powerful. Metacalibration received its name from this similarity.

In this paper, we will use metacalibrations to prove that the circle is perimeter minimizing among figures enclosing a given area. We will then use the same method to prove that the n -ball is perimeter minimizing in \mathbb{R}^n , though we will omit many details that are the same as in the proof for the circle. This will be followed by the proof of the isoperimetric problem on the surface of a n -sphere, again with some details omitted.

2 Isoperimetric Problem in \mathbb{R}^2

First we will give the full proof in \mathbb{R}^2 to introduce the style of proof. To prove that the circle minimizes perimeter, we need only to show the three (in)equalities, namely $P(\mu) = G(\mu) \leq G(\sigma) \leq P(\sigma)$. To do so, we first need a few preliminary lemmas.

Lemma 2.1. *Given an A and l , there exists a unique circle enclosing area A below a line, intersecting that line with length l .*

Proof. Construct the circle with center $(0, y)$ that passes through the points $(-l/2, 0)$ and $(l/2, 0)$. Note that the center of a circle passing through these two points must be on the y -axis.

We can look at the area of this circle below the x -axis as a function of y , $A(y)$. As y increases, the part of the new circle below the axis is contained by the part of the old circle below the axis, and so $A(y)$ is strictly decreasing. Since between any two of these circles there is another, $A(y)$ is also continuous. As y goes to infinity, $A(y)$ approaches zero. As y goes to negative infinity, $A(y)$ approaches infinity. Thus, since $A(y)$ is a continuous, monotonic function, for each area $a \in [0, \infty]$, there exists an y such that $A(y) = a$. Since $A(y)$ is monotonic, y is unique. \square

Let \mathcal{C} be the set of competitors, namely the set of 1-dimensional piecewise smooth closed curves enclosing area a_0 . For any $\sigma \in \mathcal{C}$, we set the bottom of the figure to be $y = 0$ and the top to be $y = h$. We can parameterize the figure vertically by t in the sense that at each t , there is an intersection between σ and the line $\{y = t\}$. This intersection may be empty. At t , let $A(t)$ be the area of the interior of σ below the line $\{y = t\}$, and let $l(t)$ be the length of intersection of that line with the interior of σ . We will suppress notation, and leave out the t 's.

For each $t \in [0, h]$, we define $\tau(t)$ to be the figure described in Lemma 2.1. Note how $\tau(t)$ depends on σ . For each σ , $\tau(t)$ will produce different circles. An example is shown in Figure 1. Let $r_1(t)$ be the radius of $\tau(t)$. Finally, let α be the angle between the slicing line and τ .

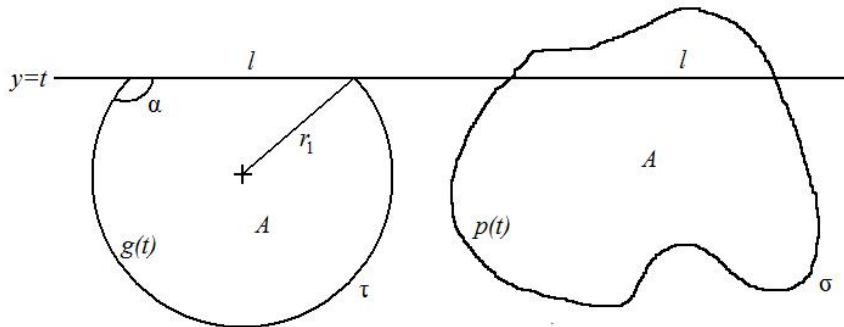

Figure 1: Constructing $\tau(t)$

Let $p(t)$ be the perimeter of σ below $\{y = t\}$, and $g(t)$ be the perimeter of τ below $\{y = t\}$. We define $G(\sigma) = g(h)$ and $P(\sigma) = p(h)$. Since $A(h) = a_0$ and $l(h) = 0$, $\tau(h)$ is a circle of area a_0 for all σ . Thus $g(h)$ is constant for all σ , and is equal to $P(\mu)$, where μ is the circle of area a_0 . Thus $P(\mu) = G(\mu) = G(\sigma)$. So, in order to prove minimization, we need only show that $G(\sigma) \leq P(\sigma)$, or in other words that $g(h) \leq p(h)$ for all σ .

In order to compare $g(h)$ and $p(h)$, we will use their derivatives, $\frac{\partial g}{\partial t}$ and $\frac{\partial p}{\partial t}$, and so in order to apply the second fundamental theorem of calculus, we need that both of the derivatives are continuous except on a countable set, and that g and p are indeed antiderivatives of the derivatives. The first is true since σ is piecewise smooth. The second requires that p and g are continuous, which is not true when there is a flat horizontal portion of perimeter of σ at some t , such as at $t = \frac{1}{2}$ in Figure 2.

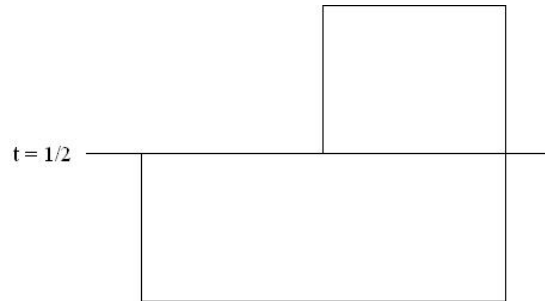

Figure 2: A figure with $p(t)$ discontinuous at $t = 1/2$

Lemma 2.2. *Any competitor σ can be rotated in order to remove any such discontinuities.*

Proof. For each $\theta \in [0, \pi)$ let the L_θ be the total length of any straight line segments in the perimeter of σ having slope $\tan(\theta)$. Suppose $L_\theta < \infty$ for all θ . We then count how many of L_θ are in each of the sets $[1, \infty]$, $[1/2, 1]$, $[1/3, 1/2]$, \dots . Since there are countably many of these sets, but uncountably many angles, at least one of these sets must have infinite L_θ in it. Then the sum of L_θ must be infinite, and so σ could not be the minimizer, as it has infinite perimeter. Thus, there is at least one angle in which σ has zero perimeter. Then rotate σ to make one of these angles horizontal in order to remove all discontinuities in $p(t)$. \square

We now prove a lower bound of $\frac{\partial p}{\partial t}$.

Lemma 2.3. *For all $\sigma \in \mathcal{C}$ and all $t \in [0, h]$,*

$$\frac{\partial p}{\partial t} \geq 2\sqrt{1 + \left(\frac{1}{2} \frac{\partial l}{\partial t}\right)^2}$$

Proof. We take a slice of σ between $y = t$ and $y = t + \epsilon$. Since ϵ is arbitrarily small, we can consider the boundary of σ to be straight lines. If there are four or more edges (i.e. pieces of boundary of σ), we can slide the separate pieces of σ together to reduce the total perimeter by reducing to two edges.

Now suppose the edges of σ are not symmetric. In Figure 3, the outer edges, which represent σ , are not symmetric. If we define l_1 and l_2 to be the distance from a common point on the line $y = t$ and on $x = c$, as in the figure, then it is easy to see that

$$\frac{\partial p}{\partial t} = \sqrt{1 + \left(\frac{\partial l_1}{\partial t}\right)^2} + \sqrt{1 + \left(\frac{\partial l_2}{\partial t}\right)^2}$$

If we treat $\frac{\partial l_1}{\partial t}$ and $\frac{\partial l_2}{\partial t}$ as variables, with their sum being $\frac{\partial l}{\partial t}$, we can directly minimize this. By some calculus, we can see that $\frac{\partial l_1}{\partial t} = \frac{\partial l_2}{\partial t} = \frac{1}{2} \frac{\partial l}{\partial t}$ minimizes the quantity, and so we have that

$$\frac{\partial p}{\partial t} \geq 2\sqrt{1 + \left(\frac{1}{2} \frac{\partial l}{\partial t}\right)^2}$$

□

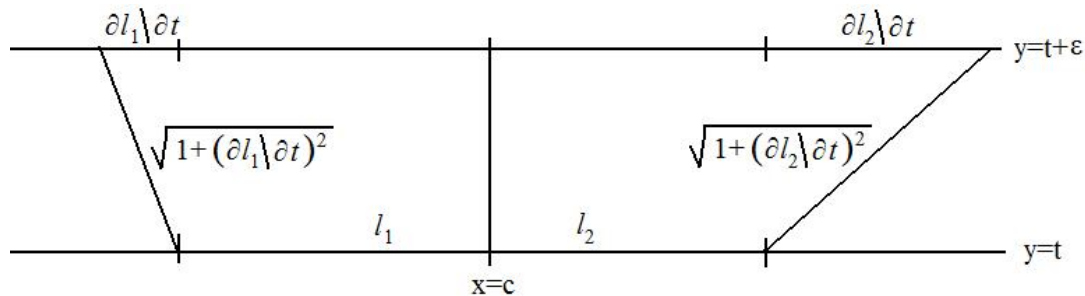

Figure 3: Minimizing $\frac{\partial p}{\partial t}$

Theorem 2.4. In \mathbb{R}^2 , for a given area a_0 , the figure enclosing a_0 that minimizes perimeter is the circle of appropriate area.

Proof. Since we have a lower bound on $\frac{\partial p}{\partial t}$, we will show that

$$\frac{\partial g}{\partial t} \leq 2\sqrt{1 + \left(\frac{1}{2} \frac{\partial l}{\partial t}\right)^2}$$

and then use that to prove the last needed inequality.

By the chain rule,

$$\frac{\partial g}{\partial t} = \frac{\partial g}{\partial l} \frac{\partial l}{\partial t} + \frac{\partial g}{\partial A} \frac{\partial A}{\partial t} \tag{1}$$

We will find three of these partial derivatives.

First, since $A(t)$ changes as the length of the cross-section of σ ,

$$\frac{\partial A}{\partial t} = l$$

Next, a standard finding of differential geometry gives us

$$\frac{\partial g}{\partial A} = \kappa = \frac{1}{r_1}$$

where κ is the mean curvature of the circle τ , and r_1 is the radius. (See, for example, Frank Morgan's *Riemannian Geometry: A Beginner's Guide* [4].)

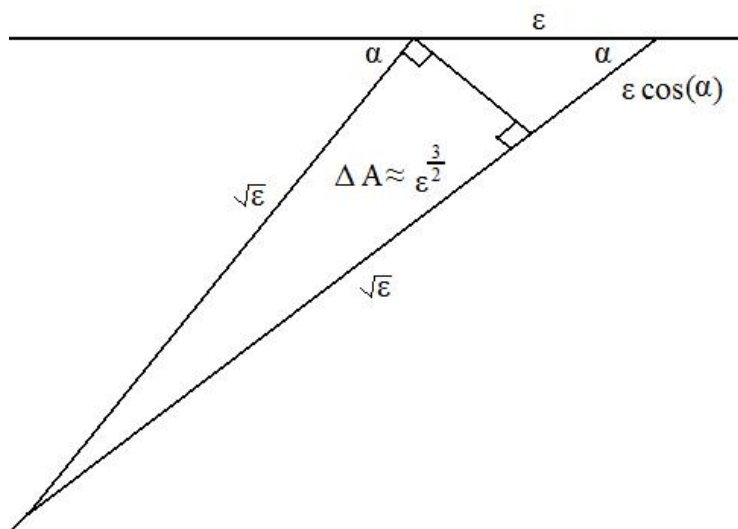

Figure 4: Extending by ϵ to find $\frac{\partial g}{\partial l}$

Next, to find $\frac{\partial g}{\partial l}$, we will extend l by ϵ , and bend the boundary of τ in the new direction, as shown in Figure 4. Again by the chain rule, we have that

$$\frac{\partial g}{\partial l} = \frac{\partial g}{\partial l} + \frac{\partial g}{\partial A} \frac{\partial A}{\partial l}$$

Since the increase in area (see Figure 4) varies as $\epsilon^{3/2}$,

$$\frac{\partial A}{\partial l} = \lim_{\epsilon \rightarrow 0} \frac{\Delta A}{\Delta l} \approx \lim_{\epsilon \rightarrow 0} \frac{\epsilon^{3/2}}{\epsilon} = 0$$

In the limit, α is also the angle between the slicing line and the modified τ . We find that the perimeter is extended by $\epsilon \cos(\alpha)$. When we take the limit as $\epsilon \rightarrow 0$ we find that

$$\frac{\partial g}{\partial l} = \lim_{\epsilon \rightarrow 0} \frac{\Delta g}{\Delta l} = \lim_{\epsilon \rightarrow 0} \frac{\epsilon \cos(\alpha)}{\epsilon} = \cos(\alpha)$$

By replacement, equation (1) becomes

$$\begin{aligned}\frac{\partial g}{\partial t} &= \cos(\alpha) \frac{\partial l}{\partial t} + \frac{l}{r_1} \\ &= 2 \left(\cos(\alpha) \frac{1}{2} \frac{\partial l}{\partial t} + \frac{l}{2r_1} \right)\end{aligned}\quad (2)$$

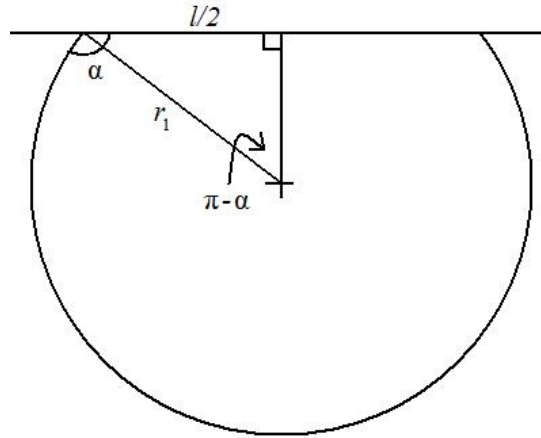

Figure 5: Finding $\sin(\alpha)$

A radius of r and half of the slicing line form two sides of a triangle, as shown in Figure 5. Trigonometry then shows us that

$$\frac{l}{2r_1} = \cos\left(\alpha - \frac{\pi}{2}\right) = \sin(\alpha)$$

Thus equation (2) becomes

$$\begin{aligned}\frac{\partial g}{\partial t} &= 2 \left(\cos(\alpha) \frac{1}{2} \frac{\partial l}{\partial t} + \sin(\alpha) \right) \\ &= 2 \langle \cos(\alpha), \sin(\alpha) \rangle \cdot \left\langle \frac{1}{2} \frac{\partial l}{\partial t}, 1 \right\rangle \leq 2 \left\| \left\langle \frac{1}{2} \frac{\partial l}{\partial t}, 1 \right\rangle \right\|\end{aligned}\quad (3)$$

by the Cauchy-Schwartz inequality.

By combining Lemma 2.3 and inequality (3) we get

$$\frac{\partial g}{\partial t} \leq 2 \left\| \left\langle \frac{1}{2} \frac{\partial l}{\partial t}, 1 \right\rangle \right\| = 2 \sqrt{1 + \left(\frac{1}{2} \frac{\partial l}{\partial t} \right)^2} \leq \frac{\partial p}{\partial t}$$

and so

$$g(h) - g(0) = \int_0^h \frac{\partial g}{\partial t} dt \leq \int_0^h \frac{\partial p}{\partial t} dt = p(h) - p(0)$$

Since $g(0) = p(0) = 0$, we have that

$$g(h) \leq p(h)$$

and by our definitions, that shows that

$$G(\sigma) \leq P(\sigma)$$

Thus we have proved by metacalibration that the circle encloses a given area with the least perimeter. \square

3 Isoperimetric Problem in \mathbb{R}^n

The proof in n dimensions follows the same outline, but of course with different details. We will leave out some of the details that are similar. We work in \mathbb{R}^{n+1} rather than \mathbb{R}^n to simplify several coefficients and subscripts, but the proof is exactly same.

Theorem 3.1. *In \mathbb{R}^n , for a given n -volume v_0 , the figure enclosing v_0 that minimizes $(n-1)$ -dimensional perimeter is the n -ball of appropriate volume.*

From here on, volume means $(n+1)$ -dimensional volume, area means n -dimensional area, and perimeter means n -dimensional surface area.

Let \mathcal{C} be the set of competitors, namely the set of n -dimensional piecewise smooth compact manifolds (essentially surfaces) enclosing volume v_0 . We use the standard x_1, x_2, \dots, x_{n+1} for our basis. For any $\sigma \in \mathcal{C}$, we set the bottom of the figure to be $x_{n+1} = 0$, and the top to be $x_{n+1} = h$. We can parameterize the figure by t in the sense that at each t , there is an intersection between σ and the plane $\{x_{n+1} = t\}$. This intersection may be empty. At t , let V be the volume of the interior of σ below the plane $\{x_{n+1} = t\}$, and let A be the area of intersection of that plane with the interior of σ .

For each $t \in [0, h]$, we construct τ as follows. On some plane, pick a n -ball of area A . We call the radius of this ball r_2 . Let $\tau(t)$ be the portion of the $(n+1)$ -ball below that plane that intersects this n -ball and that also contains volume V below that plane. Let r_1 be the radius of $\tau(t)$. That $\tau(t)$ is unique up to translation given V and A is shown by a proof very similar to Lemma 2.1, so we do not include the proof.

Let $p(t)$ be the perimeter of σ below $\{x_{n+1} = t\}$, and $g(t)$ be the perimeter of τ below $\{x_{n+1} = t\}$. We again define $G(\sigma) = g(h)$ and $P(\sigma) = p(h)$. Since $V(h) = v_0$ and $A(h) = 0$, $\tau(h)$ is a $(n+1)$ -ball for all σ . Thus $g(h)$ is constant for all σ , and is equal to $P(\mu)$, where μ is the sphere of volume v_0 . Thus $P(\mu) = G(\mu) = G(\sigma)$. So, in order to prove minimization, we need only show that $G(\sigma) \leq P(\sigma)$, or in other words that $g(h) \leq p(h)$ for all σ .

Let α be the incident angle between the slicing plane and the tangent plane to τ at any point of their intersection. This is analogous to how we picked α in the \mathbb{R}^2 case.

We will again be comparing $g(t)$ and $p(t)$ by their derivatives, $\frac{\partial g}{\partial t}$ and $\frac{\partial p}{\partial t}$, and so in order to apply the second fundamental theorem of calculus, we need that both of the derivatives

are continuous except on a countable set, and that g and p are indeed antiderivatives of the derivatives. The first is true since σ is piecewise smooth. The second requires that p and g are continuous, which is not true when there is a flat horizontal portion of perimeter at some t , as before.

We again find an upper bound on $\frac{\partial p}{\partial t}$.

Lemma 3.2. *For all $\sigma \in \mathcal{C}$ and all $t \in [0, h]$,*

$$\frac{\partial p}{\partial t} \geq nC_n r_2^{n-1} \sqrt{1 + \left(\frac{\partial r_2}{\partial t}\right)^2}$$

We omit the proof of this lemma. It is similar in principle to Lemma 2.3, though it relies on the lower dimensional case. The $nC_n r_2^{n-1}$ comes from calculating the surface area for a solid of revolution, where C_n is the volume of a unit $(n-1)$ ball.

The proof that we can rotate our figure σ to remove such discontinuities is completely equivalent to Lemma 2.2, and so we omit it.

Proof of Theorem 3.1. By the chain rule,

$$\frac{\partial g}{\partial t} = \frac{\partial g}{\partial r_2} \frac{\partial r_2}{\partial t} + \frac{\partial g}{\partial V} \frac{\partial V}{\partial t} \quad (4)$$

where r_2 is the radius of the slice of $\tau(t)$. We will find three of these partial derivatives.

First, since $V(t)$ changes as the area of the cross-section of σ ,

$$\frac{\partial V}{\partial t} = A(t) = C_n r_2^n$$

where C_n is the volume of an unit $(n-1)$ -ball.

Next, a standard finding of differential geometry gives us

$$\frac{\partial g}{\partial V} = \kappa = \frac{n}{r_1}$$

where κ is the mean curvature of the $(n+1)$ -ball τ , and r_1 is the radius. Again, see [4].

Next, to find $\frac{\partial g}{\partial r_2}$, we proceed as we did before in finding $\frac{\partial g}{\partial l}$. By extending r_2 instead of l , we extend a whole ring of τ , instead of just a line. Thus, the width of the ring is the same as the old $\frac{\partial g}{\partial l}$. We then calculate the volume of a solid of revolution to find that

$$\frac{\partial g}{\partial r_2} = \cos(\alpha) n C_n r_2^{n-1}$$

By replacement, equation (4) becomes

$$\frac{\partial g}{\partial t} = \cos(\alpha) n C_n r_2^{n-1} \frac{\partial r_2}{\partial t} + \frac{n}{r_1} C_n r_2^n$$

$$= nC_n r_2^{n-1} \left(\cos(\alpha) \frac{\partial r_2}{\partial t} + \frac{r_2}{r_1} \right) \quad (5)$$

A radius of τ and of the ball in τ that intersects the slicing plane form two sides of a triangle, as shown in Figure 5, though with r_2 instead of $l/2$. Trigonometry then shows us that

$$\frac{r_2}{r_1} = \cos\left(\alpha - \frac{\pi}{2}\right) = \sin(\alpha)$$

Thus equation (5) becomes

$$\begin{aligned} \frac{\partial g}{\partial t} &= nC_n r_2^{n-1} \left(\cos(\alpha) \frac{\partial r_2}{\partial t} + \sin(\alpha) \right) \\ &= nC_n r_2^{n-1} \langle \cos(\alpha), \sin(\alpha) \rangle \cdot \left\langle \frac{\partial r_2}{\partial t}, 1 \right\rangle \leq nC_n r_2^{n-1} \left\| \left\langle \frac{\partial r_2}{\partial t}, 1 \right\rangle \right\| \end{aligned} \quad (6)$$

by the Cauchy-Schwartz inequality.

By combining Lemma 3.2 and inequality (6) we get

$$\frac{\partial g}{\partial t} \leq nC_n r_2^{n-1} \left\| \left\langle \frac{\partial r_2}{\partial t}, 1 \right\rangle \right\| = nC_n r_2^{n-1} \sqrt{1 + \left(\frac{\partial r_2}{\partial t} \right)^2} \leq \frac{\partial p}{\partial t}$$

and so

$$g(h) - g(0) = \int_0^h \frac{\partial g}{\partial t} dt \leq \int_0^h \frac{\partial p}{\partial t} dt = p(h) - p(0)$$

Since $g(0) = p(0) = 0$, we have that

$$g(h) \leq p(h)$$

and by our definitions, that shows that

$$G(\sigma) \leq P(\sigma)$$

Thus we have proved by metacalibration that the n -ball encloses a given volume with minimum perimeter.

4 Isoperimetric Problem on a n -Sphere

The general principle of this proof is the same as the previous ones, but there are some new pieces to the proof. As before, we will omit some details that are very similar to the previous section.

Theorem 4.1. *On the surface of a standard n -sphere, for a given n -dimensional volume v_0 , the figure enclosing v_0 that minimizes perimeter is an n -dimensional geodesic ball.*

In this section, volume refers to n -dimensional volume, and area refers to $(n - 1)$ dimensional volume, and perimeter refers to $(n - 1)$ -dimensional boundary of a manifold.

Let \mathcal{C} be the set of competitors, namely the set of $(n - 1)$ -dimensional piecewise smooth compact manifolds (again think surfaces) enclosing volume v_0 on the surface of a n -sphere. We use standard spherical coordinates, $(\theta_1, \theta_2, \dots, \theta_{n-1}, \phi)$. For any $\sigma \in \mathcal{C}$, we can parameterize the figure by t in the sense that at each t , there is an intersection between σ and the line $\{\phi = t\}$. This intersection may be empty. We call such lines ϕ lines. At t , let V be the volume of σ below the ϕ line $\{\phi = t\}$, and let A be the area of intersection of that ϕ line with the interior of σ .

For each $t \in [0, \pi]$, we construct τ as follows. Along the ϕ line $\{\phi = t\}$, pick a $(n - 1)$ ball of area A . We call the geodesic radius of this ball r_3 . If we consider this ball to be in \mathbb{R}^{n+1} , we can consider the flat radius of this ball as well. Call this flat radius r_2 . Let $\tau(t)$ be the portion of the n ball below that ϕ line that intersects this $(n - 1)$ ball and that also contains volume V below the ϕ line. That $\tau(t)$ is unique up to translation along the ϕ line given V and A is shown by a proof again very similar to Lemma 2.1.

Let $p(t)$ be the perimeter of σ below $\{\phi = t\}$, and $g(t)$ be the perimeter of τ below $\{\phi = t\}$. We again define $P(\sigma) = p(\pi)$ and $G(\sigma) = g(\pi)$. Since $V(\pi) = v_0$ and $A(\pi) = 0$, $\tau(\pi)$ is a n -ball of volume v_0 for all σ . Thus $g(h)$ is constant for all σ , and is equal to $P(\mu)$, where μ is the n -ball of volume v_0 . Thus $P(\mu) = G(\mu) = G(\sigma)$. So, in order to prove minimization, we need only show that $G(\sigma) \leq P(\sigma)$, or in other words that $g(\pi) \leq p(\pi)$ for all σ .

Let α be the incident angle between the ϕ line and the tangent plane to τ at any point of their intersection. This is again analogous to how we picked α in the \mathbb{R}^2 isoperimetric problem. Some of the measured quantities are shown in Figure 6 for the case where $n = 3$. It is of course very difficult to draw a 4-dimensional sphere on paper, and so this shows just a piece of the problem. For $n = 3$, the ϕ lines are 3 balls, or spheres, as is τ .

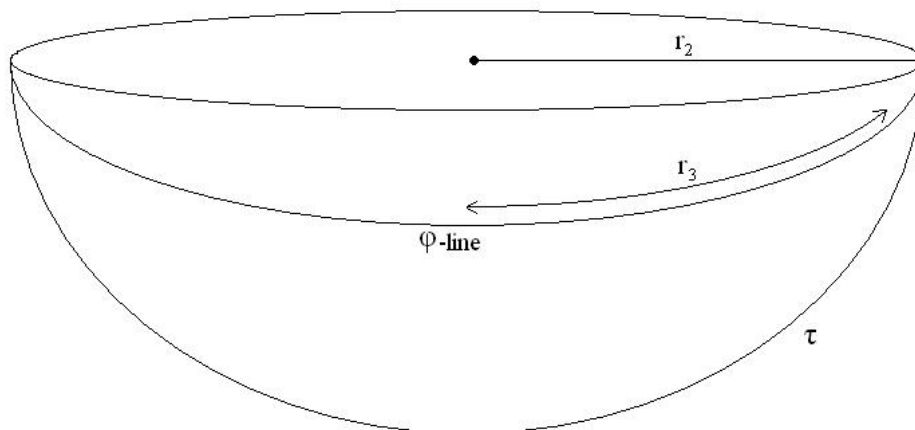

Figure 6: A slice of a sphere on a 4 ball

We will again be comparing $g(t)$ and $p(t)$ by their derivatives, $\frac{\partial g}{\partial t}$ and $\frac{\partial p}{\partial t}$, and so in order to apply the second fundamental theorem of calculus, we need that both of the derivatives are continuous except on a countable set, and that g and p are indeed antiderivatives of the derivatives. The first is true since σ is piecewise smooth. The second requires that p and g are continuous, which is not true when there is a flat horizontal portion of perimeter at some t , as before.

By a proof very similar to Lemma 2.2, we can move the pole of our ϕ lines to remove such discontinuities.

Lemma 4.2. *For all $\sigma \in \mathcal{C}$ and all $t \in (0, \pi)$,*

$$\frac{\partial p}{\partial t} \geq nC_n r_2^{n-1} \sqrt{1 + \left(\frac{dr_3}{dt} - e\right)^2}$$

where e is the the change in r_3 due to the natural expansion and contraction of ϕ lines as ϕ increases.

Again, we omit the proof of this lemma. It is almost the same as the omitted proof for Lemma 3.2, and again relies on the lower dimensional case. The $nC_n r_2^{n-1}$ is similarly from calculating the surface area for a solid of revolution, where C_n is the volume of a unit $(n - 1)$ ball.

Proof of Theorem 3.1. By the chain rule,

$$\frac{dg}{dt} = \frac{\partial g}{\partial \phi} \frac{d\phi}{dt} + \frac{\partial g}{\partial r_3} \frac{dr_3}{dt} + \frac{\partial g}{\partial V} \frac{dV}{dt} \tag{7}$$

We will set $\phi \equiv t$, and so $\frac{d\phi}{dt} = 1$.

We will find two of these partial derivatives. The last term here will cancel later, and so we will leave it as it is.

For $\frac{\partial g}{\partial r_3}$, consider a similar figure to that for $\frac{\partial g}{\partial r_2}$ in the previous section. Very similarly, we can find the change in perimeter, and take a limit, giving us that

$$\frac{\partial g}{\partial r_3} = \cos(\alpha) nC_n r_2^{n-1}$$

Next, for $\frac{\partial g}{\partial \phi}$, instead of calculating directly, we will consider a different figure. Create $\tau(t)$, but instead of changing it as usual, extend the n -ball infinitesimally, as in Figure 7. Another way to think of this would be to have the competitor σ actually be the n -ball. Call this new extended figure ν , and its perimeter $p_\nu(t)$.

This gives us a new application of the chain rule. However, several pieces are the same as before, as they are true for all n -balls on a n -sphere. Thus we get

$$\frac{dp_\nu}{dt} = \frac{\partial g}{\partial \phi} + \cos(\alpha) nC_n r_2^{n-1} \frac{dr_3}{dt} + \frac{\partial g}{\partial V} \frac{dV}{dt} \tag{8}$$

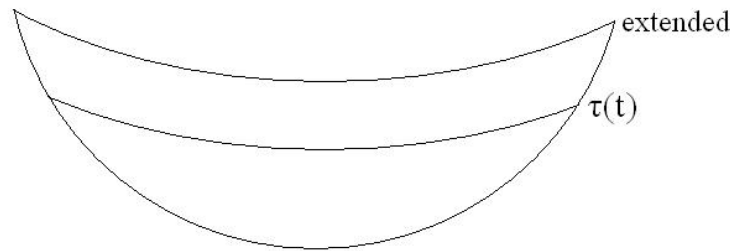

Figure 7: An extension of τ

where $\frac{\partial g}{\partial V} \frac{dV}{dt}$ is the same in both pictures because $\frac{\partial g}{\partial V}$ is the same for all such figures, and $\frac{dV}{dt}$ is just A . Note that $\frac{\partial g}{\partial \phi}$ and $\frac{dr_3}{dt}$ are in fact different here than before, but since they will only be used briefly, we will use the same notation.

If we set $\Delta t = \epsilon$, then we find that $\Delta p_\nu = \frac{\epsilon}{\sin(\alpha)} nC_n r_2^{n-1}$ and $\Delta r_3 = \epsilon(\cot(\alpha) + e)$, where e represents the change in r_3 due to the natural expansion of ϕ lines on a n -sphere. This is illustrated in Figure 8. If we then take the limit as $\epsilon \rightarrow 0$, we find that

$$\frac{dp_\nu}{dt} = \lim_{\epsilon \rightarrow 0} \frac{\Delta p_\nu}{\epsilon} = \frac{1}{\sin(\alpha)} nC_n r_2^{n-1}$$

$$\frac{dr_3}{dt} = \lim_{\epsilon \rightarrow 0} \frac{\Delta r_3}{\epsilon} = \cot(\alpha) + e$$

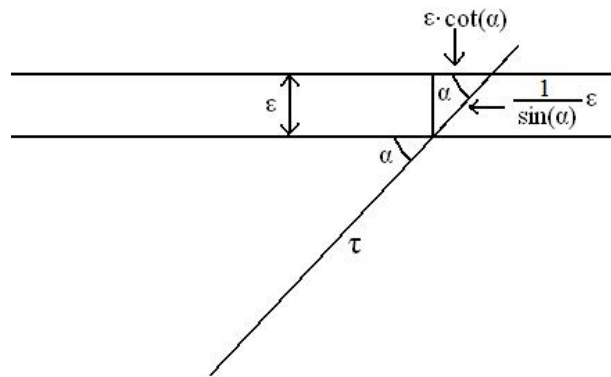

Figure 8: Finding $\frac{dp_\nu}{dt}$ and $\frac{dr_3}{dt}$

Using those equations, and rearranging equation (8) we get

$$\frac{\partial g}{\partial \phi} = nC_n r_2^{n-1} \left(\frac{1}{\sin(\alpha)} - \cos(\alpha)(\cot(\alpha) + e) \right) - \frac{\partial g}{\partial V} \frac{dV}{dt}$$

$$\begin{aligned}
&= nC_n r_2^{n-1} \left(\left(\frac{1 - \cos^2(\alpha)}{\sin(\alpha)} \right) - \cos(\alpha)e \right) - \frac{\partial g}{\partial V} \frac{dV}{dt} \\
&= nC_n r_2^{n-1} (\sin(\alpha) - \cos(\alpha)e) - \frac{\partial g}{\partial V} \frac{dV}{dt}
\end{aligned}$$

Replacing $\frac{\partial g}{\partial \phi}$ in equation (7), we get

$$\begin{aligned}
\frac{dg}{dt} &= nC_n r_2^{n-1} (\sin(\alpha) - \cos(\alpha)e) - \frac{\partial g}{\partial V} \frac{dV}{dt} + nC_n r_2^{n-1} \cos(\alpha) \frac{dr_3}{dt} + \frac{\partial g}{\partial V} \frac{dV}{dt} \\
&= nC_n r_2^{n-1} \left(\sin(\alpha) + \cos(\alpha) \left(\frac{dr_3}{dt} - e \right) \right)
\end{aligned}$$

If we split up this into two vectors and use the Cauchy-Schwartz inequality we find an upper bound for $\frac{dg}{dt}$

$$\begin{aligned}
\frac{dg}{dt} &= nC_n r_2^{n-1} (\langle \cos(\alpha), \sin(\alpha) \rangle \cdot \left\langle \frac{dr_3}{dt} - e, 1 \right\rangle) \\
&\leq nC_n r_2^{n-1} \left\| \left\langle \frac{dr_3}{dt} - e, 1 \right\rangle \right\| \tag{9}
\end{aligned}$$

By combining Lemma 4.2 and inequality (9), we get

$$\frac{dg}{dt} \leq nC_n r_2^{n-1} \left\| \left\langle \frac{dr_3}{dt} - e, 1 \right\rangle \right\| = nC_n r_2^{n-1} \sqrt{1 + \left(\frac{dr_3}{dt} - e \right)^2} \leq \frac{dp}{dt}$$

and so

$$g(\pi) - g(0) = \int_0^\pi \frac{dg}{dt} dt \leq \int_0^\pi \frac{dp}{dt} dt = p(\pi) - p(0)$$

Since $g(0) = p(0) = 0$, we have that

$$g(\pi) \leq p(\pi)$$

and by our definitions, that shows that

$$G(\sigma) \leq P(\sigma)$$

Thus we have proved by metacalibration that, on the n -sphere, the n -ball encloses a given volume with least perimeter.

5 Further Research

This paper has presented a proof for an already solved problem, but by the new and powerful method of metacalibration. The results prove may not be difficult to solve with traditional methods, but metacalibration has the potential to solve previously unsolved problems. The isoperimetric problem in more generalized symmetric spaces has been studied, but only a few results have been reached [2] [7]. We think that the method presented in this paper can and will be successful in this area.

Metacalibration has also been useful in solving other minimization problems, such as bubbles trapped in tetrahedral soap films [3], the double bubble in \mathbb{R}^n [5], and others. A natural next step would be to attempt to prove that the standard triple bubble in the plane is perimeter minimizing, which we are currently working on.

References

- [1] Viktor Blasjo. The evolution of the isoperimetric problem. *The American Mathematical Monthly*, 112:526–566, 2005.
- [2] WT. Hsiang. On the uniqueness of isoperimetric solutions and imbedded soap bubbles in non-compact symmetric spaces. *Inventiones Mathematicae*, 98(1):39–58, 1989.
- [3] Drew Johnson. The tetrahedral soap film with trapped bubble. Preprint.
- [4] Frank Morgan. *Riemannian Geometry: A Beginner's Guide*. A K Peters, 1998.
- [5] Donald Sampson and James Dilts. Metacalibration proof of the double bubble conjecture in \mathbb{R}^n . Preprint.
- [6] Jakob Steiner. Einfache beweis der isoperimetrischen hauptsätze. *J. Reine Angew. Math.*, 18:281–296, 1838.
- [7] T. Thies. A sharp isoperimetric inequality for rank one symmetric spaces. *Manuscripta Mathematica*, 111(1):97–104, 2003.
- [8] Sir William Thomson. *Popular Lectures and Addresses*, volume 2. MacMillan, 1894.
- [9] Karl Weierstrass. *Mathematische Werke*, volume 7. Mayer and Müller, 1927.