

ECE-320: Linear Control Systems
Homework 1

Due: Thursday March 8 *at the beginning of class*

Reading: Chapters 1-6, 8, 9

1) For the following transfer functions, determine both the **impulse response** and the **unit step response**.

$$H(s) = \frac{s}{(s+1)(s+2)^2} \quad H(s) = \frac{1}{(2s+1)(3s+2)}$$

$$H(s) = \frac{2}{s^2+8s+25} \quad H(s) = \frac{s+2}{s^2+2s+4}$$

Scrambled Answers:

$$h(t) = \frac{2}{3}e^{-4t} \sin(3t)u(t), \quad h(t) = -e^{-t}u(t) + e^{-2t}u(t) + 2te^{-2t}u(t), \quad h(t) = e^{-t/2}u(t) - e^{-2t/3}u(t),$$

$$h(t) = e^{-t} \cos(\sqrt{3}t)u(t) + \frac{1}{\sqrt{3}}e^{-t} \sin(\sqrt{3}t)u(t), \quad y(t) = \frac{1}{2}u(t) - 2e^{-t/2}u(t) + \frac{3}{2}e^{-2t/3}u(t),$$

$$y(t) = \frac{1}{2}u(t) + \frac{1}{2\sqrt{3}}e^{-t} \sin(\sqrt{3}t)u(t) - \frac{1}{2}e^{-t} \cos(\sqrt{3}t)u(t), \quad y(t) = e^{-t}u(t) - e^{-2t}u(t) - te^{-2t}u(t),$$

$$y(t) = \frac{2}{25}u(t) - \frac{8}{75}e^{-4t} \sin(3t)u(t) - \frac{2}{25}e^{-4t} \cos(3t)u(t)$$

2) For the following transfer functions

$$H(s) = \frac{2}{s^2+2s+2} \quad H(s) = \frac{3}{s^2+4s+6} \quad H(s) = \frac{5}{s^2+6s+10}$$

$$H(s) = \frac{4}{s^2-4s+7} \quad H(s) = \frac{1}{s^2+4}$$

By computing the inverse Laplace transform show that the step responses are given by

$$y(t) = \left[1 - e^{-t} \cos(t) - e^{-t} \sin(t) \right] u(t) \quad y(t) = \left[\frac{1}{2} - \frac{1}{\sqrt{2}}e^{-2t} \sin(\sqrt{2}t) - \frac{1}{2}e^{-2t} \cos(\sqrt{2}t) \right] u(t)$$

$$y(t) = \left[\frac{1}{2} - \frac{3}{2}e^{-3t} \sin(t) - \frac{1}{2}e^{-3t} \cos(t) \right] u(t) \quad y(t) = \left[\frac{4}{7} + \frac{8\sqrt{3}}{21}e^{2t} \sin(\sqrt{3}t) - \frac{4}{7}e^{2t} \cos(\sqrt{3}t) \right] u(t)$$

$$y(t) = \left[\frac{1}{4} - \frac{1}{4} \cos(2t) \right] u(t)$$

3) (Mason's Rule) For the block diagram shown below, determine a corresponding signal flow diagram and show that the closed loop transfer function is

$$H_{system} = \frac{G_1 G_2 G_3 + G_4 (1 - G_1 G_2 H_1 + G_2 H_1 + G_2 G_3 H_2)}{1 - G_1 G_2 H_1 + G_2 H_1 + G_2 G_3 H_2}$$

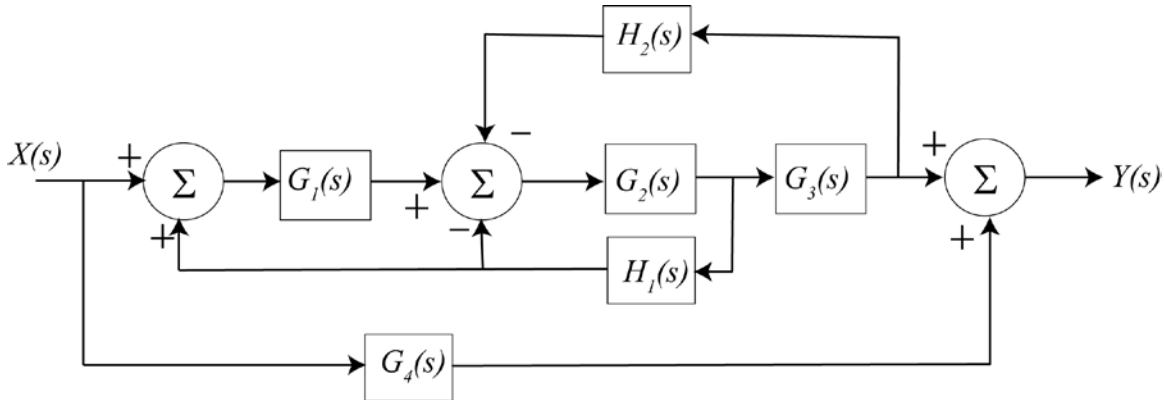

4) (Model Matching) Consider the following closed loop system, with plant $G_p(s)$ and controller $G_c(s)$.

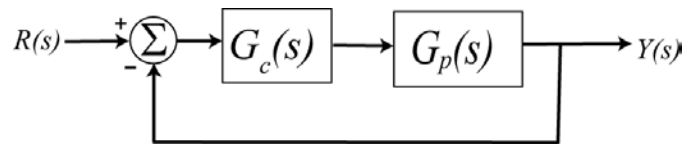

One way to choose the controller is to try and make your closed loop system match a transfer function that you choose (hence the name model matching). Let's assume that our **desired** closed loop transfer function, $G_o(s)$, our plant can be written in terms of numerators and denominators as

$$G_o(s) = \frac{N_o(s)}{D_o(s)} \quad G_p(s) = \frac{N_p(s)}{D_p(s)}$$

Show that our controller is then $G_c(s) = \frac{N_o(s)D_p(s)}{N_p(s)[D_o(s) - N_o(s)]}$

Note that there are some restrictions here, in that for implementation purposes the controller must be stable, and it must be proper.

5) For the following system, with plant $G_p(s) = \frac{1}{s+1}$, and controller $G_c(s)$

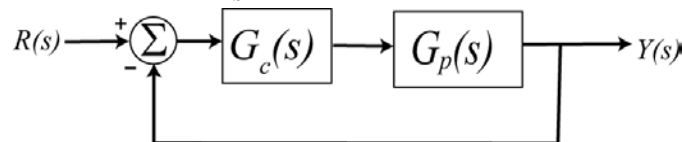

a) Using the results from problem 4, determine the controller so that the closed loop system matches a second order ITAE (Integral of Time and Absolute Error) optimal system, i.e., so that the closed loop transfer function is

$$G_0(s) = \frac{\omega_0^2}{s^2 + 1.4\omega_0 s + \omega_0^2}$$

Answer. $G_c(s) = \frac{\omega_0^2(s+1)}{s(s+1.4\omega_0)}$, note that there is a pole/zero cancellation between the controller and the plant and there is a pole at zero in the controller.

b) Show that the damping ratio for this system is 0.7, the closed loop poles of this system are at $-0.7\omega_0 \pm j0.714\omega_0$. For faster response should ω_0 be large or small?

c) Determine the controller so that the closed loop system matches a third order **deadbeat** system, i.e., so that the closed loop transfer function is

$$G_0(s) = \frac{\omega_0^3}{s^3 + 1.90\omega_0 s^2 + 2.20\omega_0^2 s + \omega_0^3}$$

Ans. $G_c(s) = \frac{\omega_0^3(s+1)}{s(s^2 + 1.9\omega_0 s + 2.20\omega_0^2)}$, note that there is a pole/zero cancellation between the controller and the plant and there is a pole at zero in the controller.

6) One of the methods that can be used to identify ζ and ω_n for mechanical systems the *log-decrement* method, which we will derive in this problem. If our system is at rest and we provide the mass with an initial displacement away from equilibrium, the response due to this displacement can be written

$$x_1(t) = Ae^{-\zeta\omega_n t} \cos(\omega_d t + \theta)$$

where

$x_1(t)$ = displacement of the mass as a function of time

ζ = damping ratio

ω_n = natural frequency

ω_d = damped frequency = $\omega_n \sqrt{1 - \zeta^2}$

After the mass is released, the mass will oscillate back and forth with period given by $T_d = \frac{2\pi}{\omega_d}$, so if we measure

the period of the oscillation (T_d) we can estimate ω_d . Let's assume t_0 is the time of one peak of the cosine. Since the cosine is periodic, subsequent peaks will occur at times given by $t_n = t_0 + nT_d$, where n is an integer.

a) Show that

$$\frac{x_1(t_0)}{x_1(t_n)} = e^{\zeta\omega_n T_d n}$$

b) If we define the log decrement as

$$\delta = \ln \left[\frac{x_1(t_0)}{x_1(t_n)} \right]$$

show that we can compute the damping ratio as

$$\zeta = \frac{\delta}{\sqrt{4n^2\pi^2 + \delta^2}}$$

c) Given the initial condition response shown in the Figures on the next page, estimate the damping ratio and natural frequency using the log-decrement method. (You should get answers that include the numbers 15, 0.2, 0.1 and 15, approximately.)

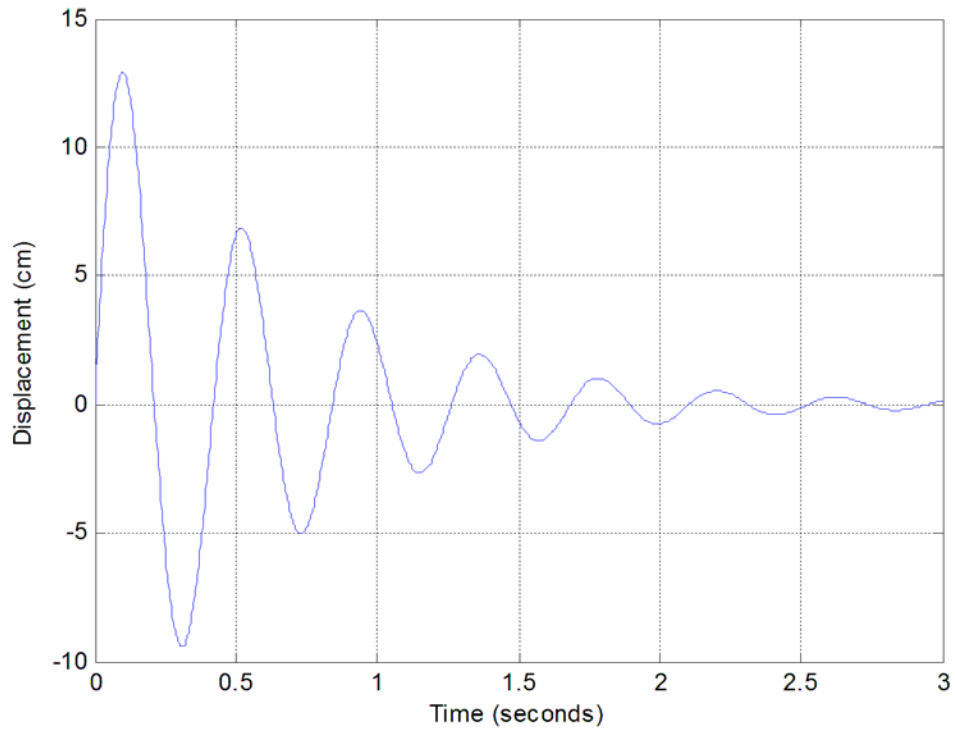

Figure 1. Initial condition response for second order system A.

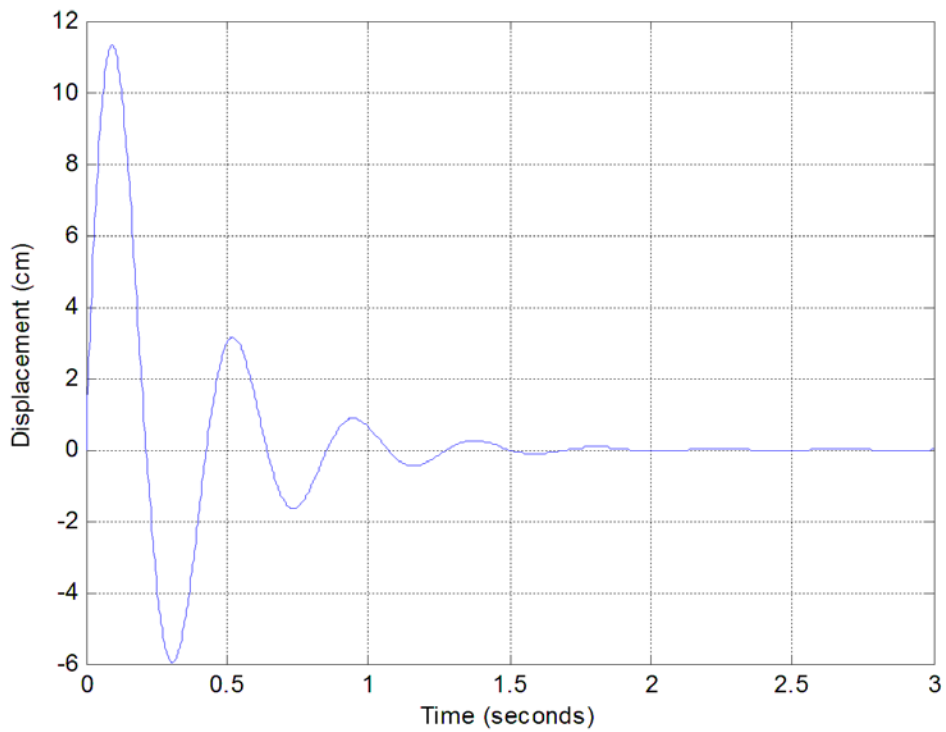

Figure 2. Initial condition response for second order system B.

Preparation for Lab 1 (to be done individually and turned in with your homework)

7) Download the file **homework1.rar** from the class website and extract the files. You will be using and modifying the files **closedloop_driver.m** and **closedloop.mdl** for much of this course.

The program **closedloop_driver.m** does the following things (try to find these in the program, it will help you later)

- sets some system parameters,
- reads in the model file **bobs_210_model.mat**, which contains a state variable model of a particular system,
- determines the transfer function representation of the system,
- determines a controller using one of two model matching methods,
- sets the input amplitude and duration of the simulation
- simulates the system using the Simulink model **closedloop.mdl**.
- plots the output of the system with the chosen controller
- plots the control effort required with the chosen controller (do not let it near the dashed blue lines)

In Lab 1 you will be determining two different system models and trying to control the models using model matching algorithms. In this prelab you will just run the file and make some changes.

a) Run the simulation as it is, for a zero position error second order ITAE closed loop system. You should get a graph identical the graph below

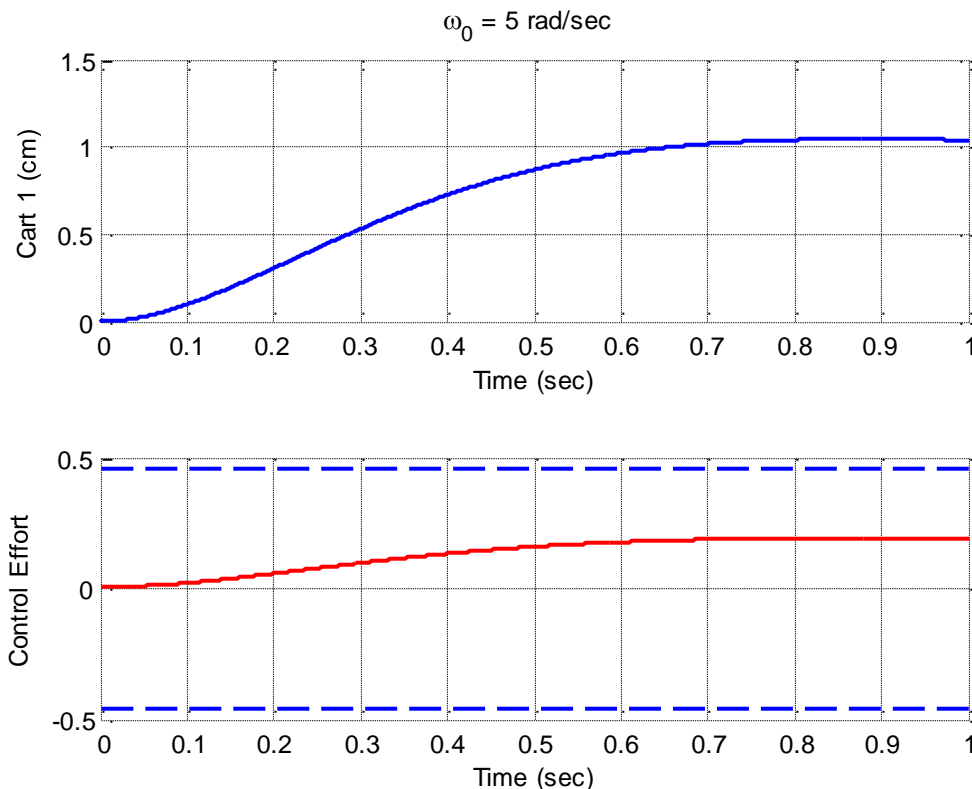

w.

b) Modify ω_0 so the settling time of the system is less than 0.5 seconds and the control effort does not saturate the system (the control effort stays between the two dashed blue lines) for the second order ITAE closed loop system. **Turn in your graph.**

c) Modify the simulation so it uses a second order deadbeat closed loop system for model matching and set $\omega_0 = 5$. Run the simulation and you should get a result like that shown below.

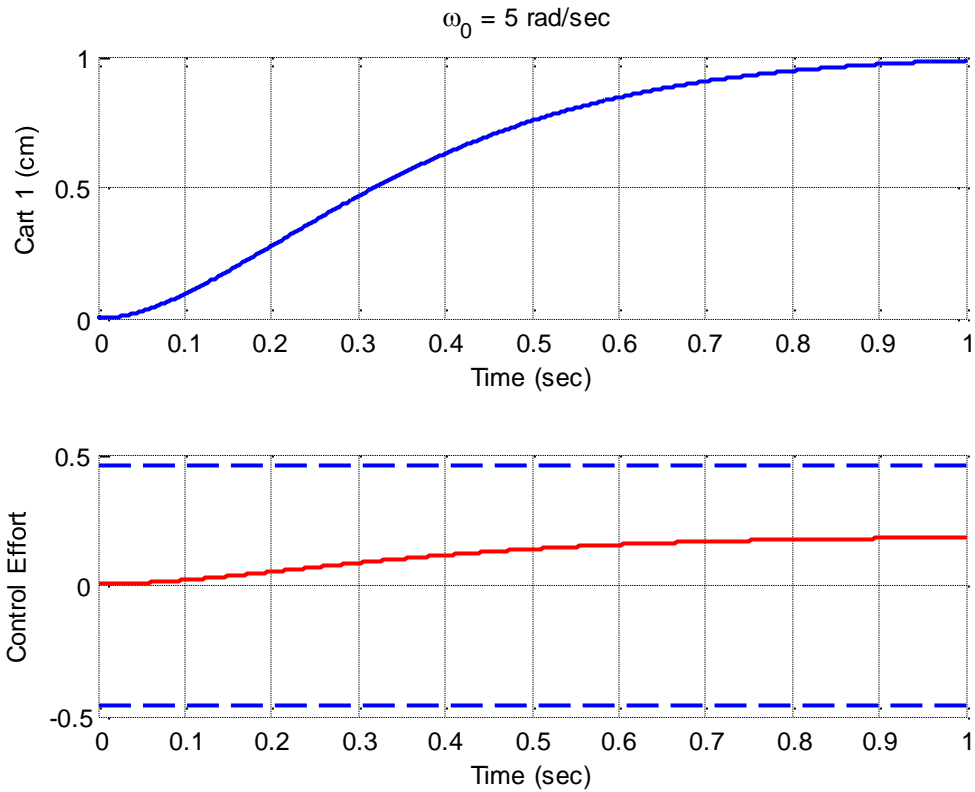

d) Modify ω_0 so the settling time of the system is less than 0.5 seconds and the control effort does not saturate the system (the control effort stays between the two dashed blue lines) for a second order deadbeat closed loop system. **Turn in your graph.**