

ECE-205 : Dynamical Systems

Homework #7

Due : Thursday February 3 at the beginning of class

Read section 6.7 for problems 8-10. You are responsible for this material, but we will not cover it in class.

1) For the following transfer functions, determine

- the characteristic polynomial
- the characteristic modes
- if the system is (asymptotically) stable, unstable, or marginally stable

$$\text{a) } H(s) = \frac{s-1}{s(s+2)(s+10)} \quad \text{b) } H(s) = \frac{s(s-1)}{(s+1)^2(s^2+s+1)} \quad \text{c) } H(s) = \frac{1}{s^2(s+1)}$$

$$\text{d) } H(s) = \frac{s^2-1}{(s-1)(s+2)(s^2+1)} \quad \text{e) } H(s) = \frac{1}{(s^2+2)(s+1)}$$

Partial Answer: 1 stable, 2 unstable, 2 marginally stable

2) For a system with the following pole locations, estimate the settling time and determine the dominant poles

- a) -1, -2, -4, -5 b) -4, -6, -7, -8
c) -1+j, -1-j, -2, -3 d) -3-2j, -3+2j, -4+j, -4-j

Scrambled Answers: 4/3, 4, 4, 1

3) Determine the static gain for the systems represented by the following transfer functions, and then the steady state output for an input step of amplitude 3:

$$H(s) = \frac{s+2}{s^2+s+1}, \quad H(s) = \frac{1}{s^2+4s+4}, \quad H(s) = \frac{s-4}{s^2+s+1}$$

Answers: 2, 0.25, -4, 6, 0.75, -12 (this should be very easy)

4) Consider the following simple feedback control block diagram. The plant, the thing we want to control, has the transfer function $G_p(s) = \frac{3}{s+2}$ and the controller is a proportional controller, so $G_c(s) = k_p$.

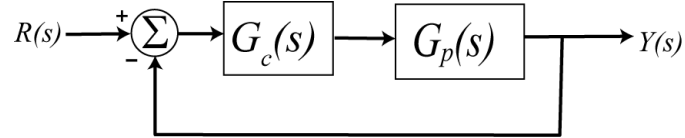

- a) Determine the settling time of the plant alone (assuming there is no feedback)
- b) Determine the closed loop transfer function, $G_0(s)$
- c) Determine the value of k_p so the settling time of the system is 0.5 seconds.
- d) If the input to the system is a unit step, determine the output of the system.
- e) The steady state error is the difference between the input and the output as $t \rightarrow \infty$. Determine the steady state error for this system.

Partial Answer: $y(t) = \frac{3}{4} [1 - e^{-8t}] u(t)$, $e_{ss} = 0.25$

5) Show that the following circuit can be used to implement the PI controller

$$G_c(s) = \frac{U(s)}{E(s)} = k_p + k_i \frac{1}{s} = \frac{R_4 R_2}{R_3 R_1} + \frac{R_4}{R_3 R_1 C_2} \frac{1}{s}$$

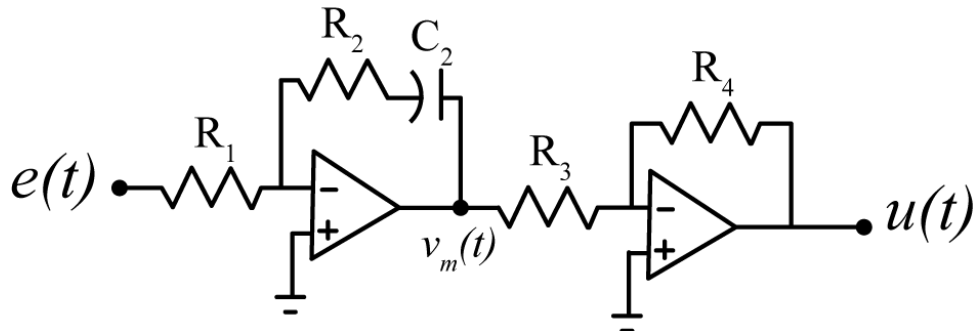

6) Consider the following simple feedback control block diagram. The plant, the thing we want to control, has the transfer function $G_p(s) = \frac{3}{s+2}$ and the controller is an integral controller, so $G_c(s) = \frac{k_i}{s}$.

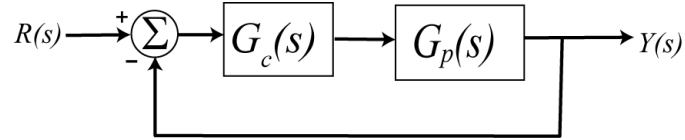

- Determine the closed loop transfer function, $G_0(s)$
- Determine the poles of value of $G_0(s)$ and show they are only real if $0 < k_i < \frac{1}{3}$. Note that the best possible settling time is 4 seconds. Use $k_i = \frac{1}{3}$ for the remainder of this problem.
- If the input to the system is a unit step, determine the output of the system.
- The steady state error is the difference between the input and the output as $t \rightarrow \infty$. Determine the steady state error for this system.

Partial Answer: $y(t) = [1 - e^{-t} - te^{-t}]u(t)$, $e_{ss} = 0$

7) Consider the following simple feedback control block diagram. The plant is $G_p(s) = \frac{2}{s+4}$. The input is a unit step.

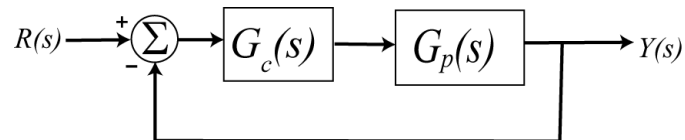

- Determine the settling time and steady state error of the plant alone (assuming there is no feedback)
- Assuming a proportional controller, $G_c(s) = k_p$, determine the closed loop transfer function, $G_0(s)$
- Assuming a proportional controller, $G_c(s) = k_p$, determine the value of k_p so the steady state error for a unit step is 0.1, and the corresponding settling time for the system.
- Assuming a proportional controller, $G_c(s) = k_p$, determine the value of k_p so the settling time is 0.5 seconds, and the corresponding steady state error.
- Assuming an integral controller, $G_c(s) = k_i / s$, determine closed loop transfer function, $G_0(s)$
- Assuming an integral controller, $G_c(s) = k_i / s$, determine the value of k_i so the steady state error for a unit step is less than 0.1 and the system is stable.

Partial Answers: $T_s = 1$, $e_{ss} = 0.5$, $k_p = 18$, $k_p = 2$, $T_s = 0.1$, $e_{ss} = 0.5$, $k_i > 0$

8) For the following signal flow diagrams determine the system transfer function. You may use Maple.

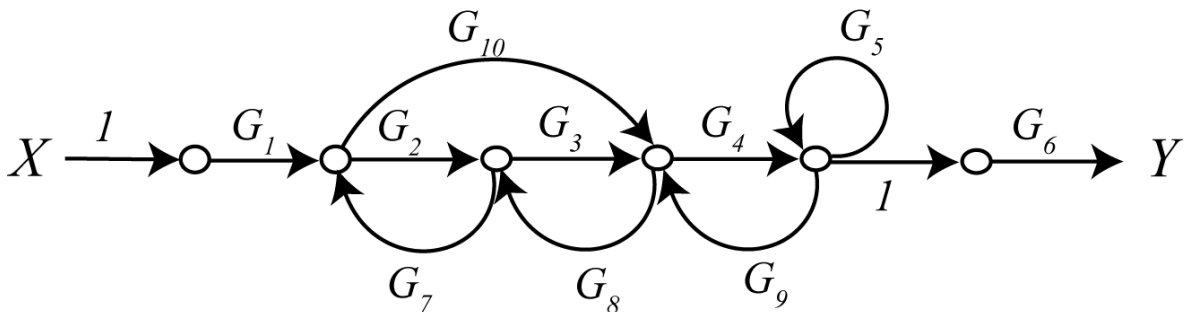
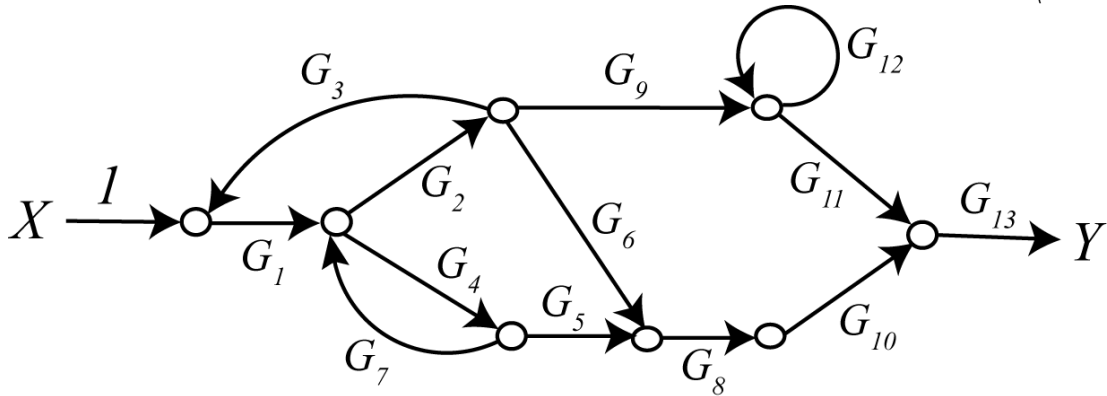
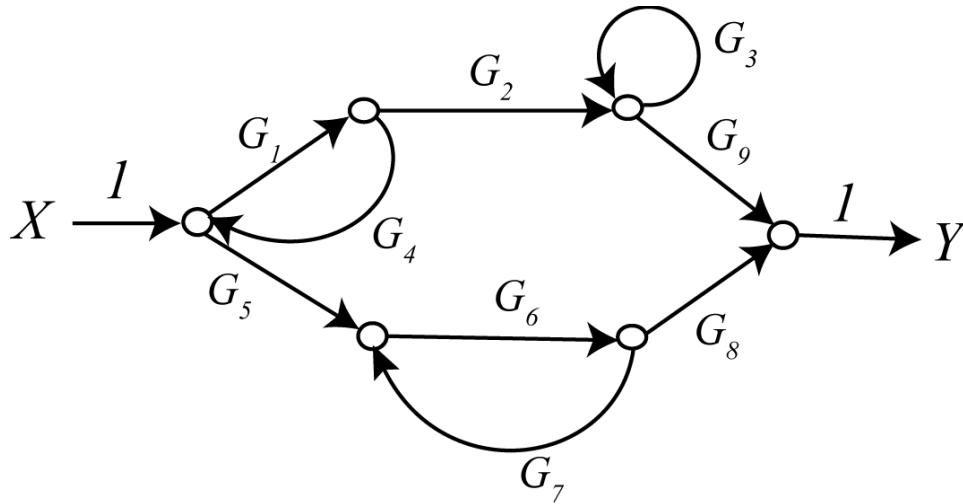

Answers:

$$\frac{Y}{X} = \frac{G_1 G_2 G_9 (1 - G_6 G_7) + G_5 G_6 G_8 (1 - G_3)}{1 - G_1 G_4 - G_6 G_7 - G_3 + G_1 G_4 G_6 G_7 + G_1 G_3 G_4 + G_3 G_6 G_7 - G_1 G_3 G_4 G_6 G_7}$$

$$\frac{Y}{X} = \frac{G_1 G_2 G_3 G_4 G_6 + G_1 G_4 G_6 G_{10}}{1 - G_2 G_7 - G_3 G_8 - G_4 G_9 - G_7 G_8 G_{10} - G_5 + G_2 G_4 G_7 G_9 + G_2 G_5 G_7 + G_3 G_5 G_8 + G_5 G_7 G_8 G_{10}}$$

$$\frac{Y}{X} = \frac{G_1 G_2 G_9 G_{11} G_{13} + G_1 G_2 G_6 G_8 G_{10} G_{13} (1 - G_{12}) + G_1 G_4 G_5 G_8 G_{10} G_{13} (1 - G_{12})}{1 - G_1 G_2 G_3 - G_{12} - G_4 G_7 + G_1 G_2 G_3 G_{12} + G_4 G_7 G_{12}}$$

9) We can also use Mason's rule for systems with multiple inputs and multiple outputs. To do this, we use superposition and assume only one input is non-zero at a time. The only things that changes are the paths (which depends on the input and the output) and the cofactors (which depends on the path). The determinant does not change, since it is intrinsic to the system. For the following systems, determine the transfer functions from all inputs (R) to all outputs (Y). *You may use Maple.*

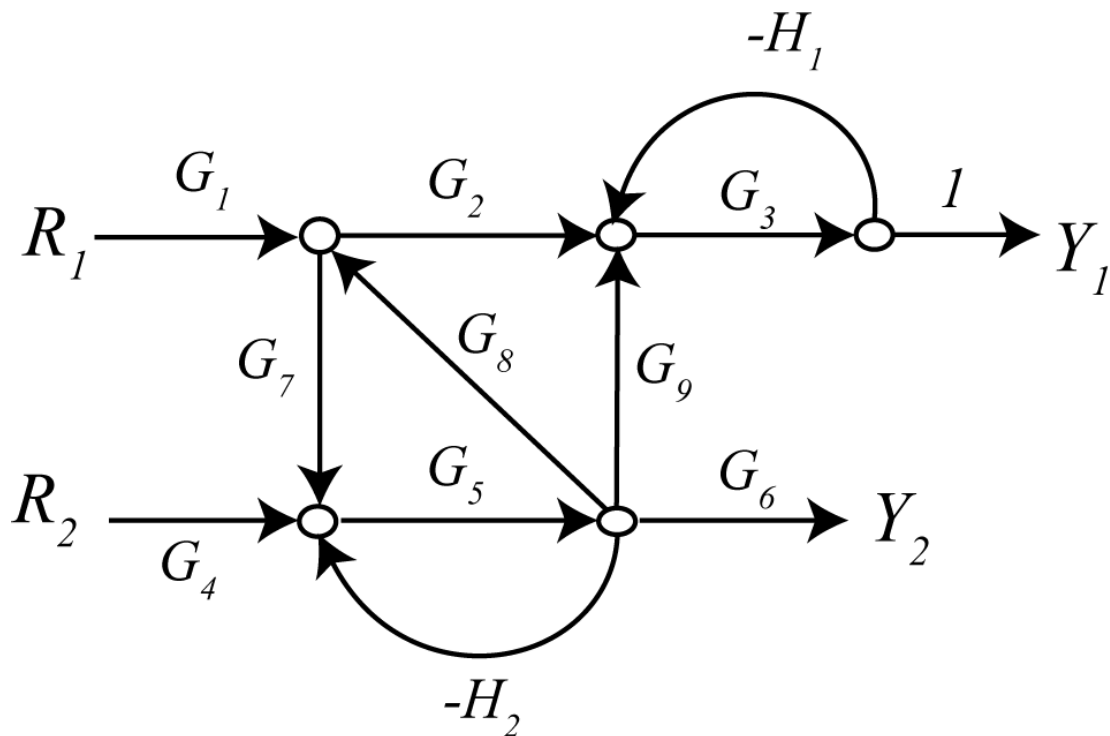
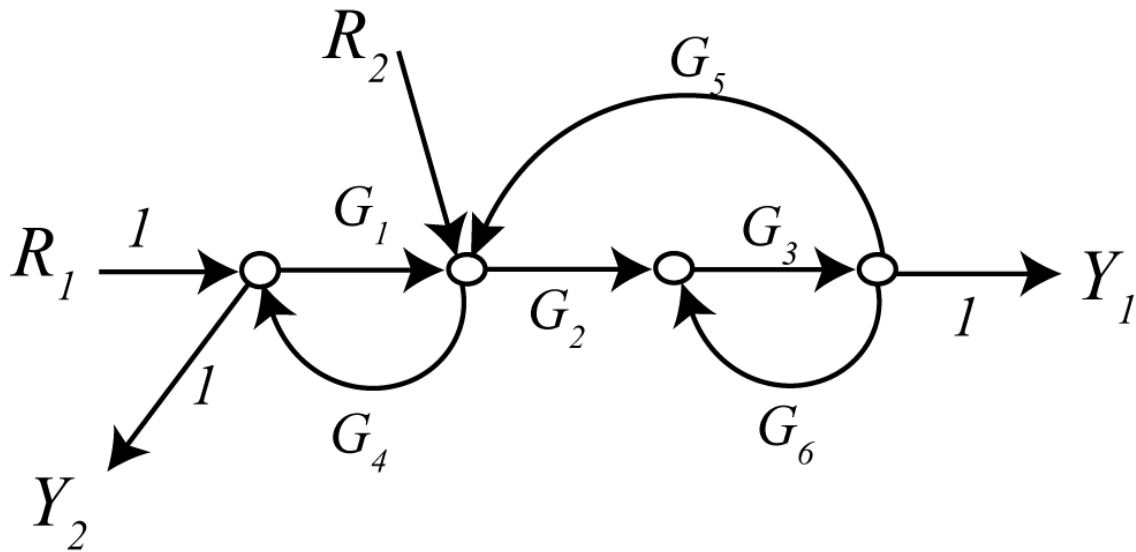

Answers:

$$\frac{Y1}{R1} = \frac{G_1 G_2 G_3}{1 - G_1 G_4 - G_2 G_3 G_5 - G_3 G_6 + G_1 G_3 G_4 G_6},$$

$$\frac{Y2}{R1} = \frac{1 - G_2 G_3 G_5 - G_3 G_6}{1 - G_1 G_4 - G_2 G_3 G_5 - G_3 G_6 + G_1 G_3 G_4 G_6}$$

$$\frac{Y1}{R2} = \frac{G_2 G_3}{1 - G_1 G_4 - G_2 G_3 G_5 - G_3 G_6 + G_1 G_3 G_4 G_6},$$

$$\frac{Y2}{R2} = \frac{G_4 (1 - G_3 G_6)}{1 - G_1 G_4 - G_2 G_3 G_5 - G_3 G_6 + G_1 G_3 G_4 G_6}$$

$$\frac{Y1}{R1} = \frac{G_1 G_2 G_3 (1 + G_5 H_2) + G_1 G_3 G_5 G_7 G_9}{1 + G_5 H_2 - G_5 G_7 G_8 + H_1 G_3 + G_3 G_5 H_1 H_2 - H_1 G_3 G_5 G_7 G_8},$$

$$\frac{Y2}{R1} = \frac{G_1 G_5 G_6 G_7 (1 + G_3 H_1)}{1 + G_5 H_2 - G_5 G_7 G_8 + H_1 G_3 + G_3 G_5 H_1 H_2 - H_1 G_3 G_5 G_7 G_8}$$

$$\frac{Y1}{R2} = \frac{G_3 G_4 G_5 G_9 + G_2 G_3 G_4 G_5 G_8}{1 + G_5 H_2 - G_5 G_7 G_8 + H_1 G_3 + G_3 G_5 H_1 H_2 - H_1 G_3 G_5 G_7 G_8},$$

$$\frac{Y2}{R2} = \frac{G_4 G_5 G_6 (1 + H_1 G_3)}{1 + G_5 H_2 - G_5 G_7 G_8 + H_1 G_3 + G_3 G_5 H_1 H_2 - H_1 G_3 G_5 G_7 G_8}$$

10) For the block diagram shown below, determine a corresponding signal flow diagram and show that the closed loop transfer function is

$$H_{system} = \frac{G_1 G_2 G_3 + G_4 (1 - G_1 G_2 H_1 + G_2 H_1 + G_2 G_3 H_2)}{1 - G_1 G_2 H_1 + G_2 H_1 + G_2 G_3 H_2}$$

